

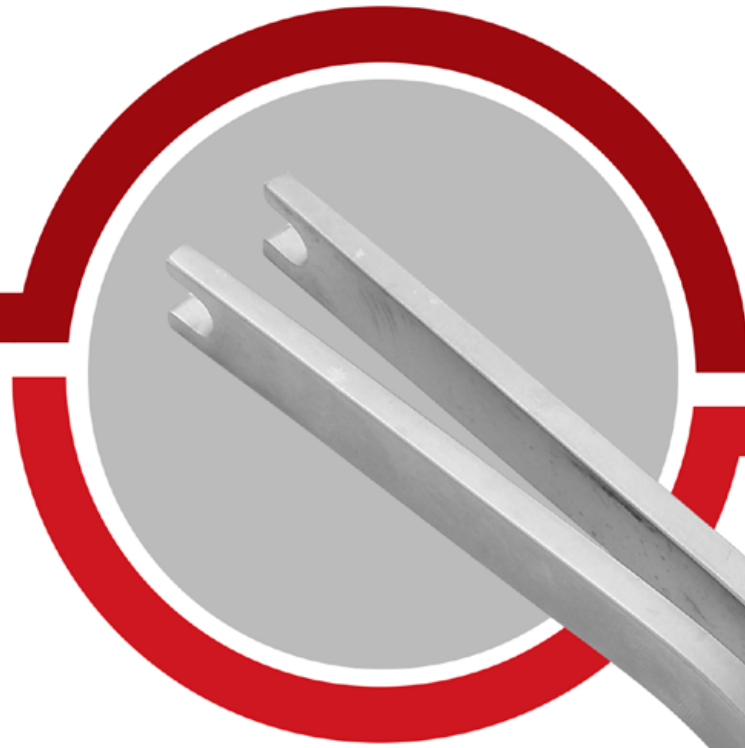

M.ASHRAF
INSTRUMENTS



SURGICAL INSTRUMENTS
CATALOUGE



M.ASHRAF
INSTRUMENTS



ABOUT



Founder
Muhammad Ashraf (Late)



C.E.O
Azhar Ashraf



Director Marketing
M. Arfan Ali

M.ASHRAF INSTRUMENTS was founded in the year of 1984 and now an icon in the field of Surgical and Spinal Surgery Instruments manufacturers, with decades of rich and professional experience, we are extremely pleased to present this updated version of catalogue of high quality surgical instruments.

We have acquired a vast selection of instruments for almost all surgical disciplines.

M.ASHRAF INSTRUMENTS products are exported to all the continents of the world and liked by Medical Professional / Doctors, Surgeons, Para Medical professionals, Hospital Administrators, Pathologists, Radiologists, Physiotherapists, Distributors / Traders, importers and Senior Professionals from both Government and Private Hospitals. M.ASHRAF INSTRUMENTS is supported by the induction of the quality management and assurance system according of ISO 9001-2008 & CE marking.

We further want to not only ensure our valued consumers for our high quality products but also guarantee our products to satisfy environmental and moral standards. We have excellent working conditions in our works where the goods are produced. Thus our products will be more competitive and can maintain their niche in the market with our highest environmental and social compliance standards.

QUALITY:

We are committed to providing the medical professionals with the high quality, cost-effective surgical instruments. We strive to match or exceed the requirements and expectations of practitioners used to spending up to three and four times as much for their instrument inventory. We pledge to provide you with the finest in materials, craftsmanship and value available in our industry. As a matter of fact, WE GUARANTEE IT.

FEATURES:

We carry out all the necessary tests, inspections and process control activated to that there is no problem with the products. We will also give the technical specifications to improve the confidence of the customer.

OUR PROMISE:

Our experienced and dedicated craftsmen have the most modern, state-of-the-art factory in the region. We invest in the latest German polishing, grinding, heat treatment and etching machines that ensure that M.ASHRAF INSTRUMENTS can hold their own with even the priciest branded lines.

CERTIFICATIONS





Finishing Hall



Checking & Packing Hall



Store Room



Sterilizing Unit



Forging Store



ONE



M.ASHRAF
INSTRUMENTS

Oberflächenbeschreibung	Surface Description	SC 1 - SC 4
Mikro - Federscheren	<i>Micro Spring Scissors</i>	SC 5 - 16
Feine Scheren	<i>Delicate Scissors</i>	SC 17 - 23
Feine chirurgische Scheren	<i>Delicate Surgical Scissors</i>	SC 24 - 26
Chirurgische Scheren	<i>Surgical Scissors</i>	SC 27 - 31
Feine Präparierscheren	<i>Delicate Dissecting Scissors</i>	SC 32 - 37
Enukleationsscheren	<i>Enucleation Scissors</i>	SC 38
Präparierscheren	<i>Dissecting Scissors</i>	SC 39 - 51, 54 - 63
Facelift- und Nasenscheren	<i>Facelift and Nasal Scissors</i>	SC 52 - 53
Nasenscheren	<i>Nasal Scissors</i>	SC 64 - 67
Gefäßscheren	<i>Vascular Scissors</i>	SC 68 - 75
Neurochirurgische Scheren	<i>Neurosurgical Scissors</i>	SC 76 - 77
Tonsillen-Scheren	<i>Tonsil Scissors</i>	SC 78 - 79
Darmscheren	<i>Enterotomy Scissors</i>	SC 80
Ligaturscheren	<i>Ligature Scissors</i>	SC 81 - 82
Gynäkologische Scheren	<i>Gynecological Scissors</i>	SC 83 - 86
Nabelschnurscheren	<i>Umbilical Scissors</i>	SC 87
Damm-(Episiotomie-)Scheren	<i>Perineum (Episiotomy) Scissors</i>	SC 88
Parametriumscheren	<i>Parametrium Scissors</i>	SC 89
Kronenscheren	<i>Crown Scissors</i>	SC 90
Zahnfleischscheren	<i>Gum Scissors</i>	SC 91 - 92
Nagelscheren	<i>Nail Scissors</i>	SC 93
Draht-, Blechscheren	<i>Wire, Metal Cutting Scissors</i>	SC 94
Verbandscheren	<i>Bandage Scissors</i>	SC 95 - 101
Gipsscheren	<i>Plaster Shears</i>	SC 102
Knochenscheren	<i>Bone Scissors</i>	SC 103
Rippenscheren	<i>Rib Shears</i>	SC 104

Standard-Schere

hergestellt aus hochwertigem Edelstahl

Standard Scissors

manufactured of high grade stainless steel



MA 1331-18

SuperCut-Schere (MC)

unteres Blatt mit rasiermesserscharfer Schneide
oberes Blatt mikrofein gezahnt

Erkennungsmerkmale: +
schwarze Ringe und
+ **zusätzlich endet die Artikelnummer mit dem Buchstaben "M"**



SuperCut Scissors (MC)

*lower blade with razor-sharp cutting edge
micro serrated upper blade*

Identifying features: +
black rings and
+ **additionally the article number ends with the letter "M"**

MA 1331-18M

Schere mit Keramikbeschichtung (CC)

Keramikbeschichtung

Erkennungsmerkmale:
+ schwarze Keramikbeschichtung,
+ vergoldete Schraube und
+ **zusätzlich endet die Artikelnummer mit dem Buchstaben "C"**



Scissors with Ceramic Coating (CC)

ceramic coating

Identifying features:
+ black ceramic coating,
+ gold plated screw and
+ **additionally the article number ends with the letter "C"**

MA 1331-18C

SuperCut-Schere mit Keramikbeschichtung (MC/CC)

unteres Blatt mit rasiermesserscharfer Schneide und oberes Blatt mikrofein gezahnt (MC)
Keramikbeschichtung (CC)

Erkennungsmerkmale:

- + schwarze Keramikbeschichtung,
- + vergoldete Schraube und
- + **zusätzlich endet die Artikelnummer mit dem Buchstaben "N"**



MA 1331-18N

SuperCut Scissors with Ceramic Coating (MC/CC)

lower blade with razor-sharp cutting edge and microfine serrated upper blade (MC)
ceramic coating (CC)

Identifying features:

- + black ceramic coating,
- + gold plated screw and
- + additionally the article number ends with the letter "N"

RUDOLF Supreme-Line (S)

hergestellt aus hochwertigem Edelstahl
besonderes feines Finish in der Schneide und extrem weicher Gang

Erkennungsmerkmale:

- + Hochglanzpolierte Arbeitsenden
- + Zusätzlich endet die Artikelnummer mit dem Buchstaben "S"



MA 1331-18S

RUDOLF Supreme-Line (S)

manufactured of high grade stainless steel
extremely fine finish of the cutting edges and very easy cutting movement

Identifying features:

- + highly polished working ends
- + additionally the article number ends with the letter "S"

Hartmetallschere (TC)

Schneiden mit aufgeschweißtem Hartmetall

Erkennungsmerkmale:

- + vergoldete Ringe



MA 1334-18

Hard Metal Scissors (TC)

blades with welded hard metal

Identifying features: +
gold plated rings

Hartmetall-SuperCut-Schere (TC/MC)

Schneiden mit aufgeschweißtem Hartmetall
unteres Blatt mit rasiermesserscharfer Schneide und oberes Blatt mikrofein gezahnt (MC)

Erkennungsmerkmale:

- + lang vergoldete Ringe und
- + zusätzlich endet die Artikelnummer mit dem Buchstaben "M"



Hard Metal SuperCut Scissors (TC/MC)

MA 1334-18M

blades with welded hard metal
lower blade with razor-sharp cutting edge and microfine serrated upper blade (MC)

Identifying features:

- + long gold plated rings and
- + additionally the article number ends with the letter "M"

Hartmetallschere mit Keramikbeschichtung (TC/CC)

Schneiden mit aufgeschweißtem Hartmetall
Keramikbeschichtung (CC)

Erkennungsmerkmale:

- + schwarze Keramikbeschichtung,
- + vergoldete Ringe,
- + vergoldete Schraube und
- + **zusätzlich endet die Artikelnummer mit dem Buchstaben "C"**



Hard Metal Scissors with Ceramic Coating (TC/CC)

MA 1334-18C

blades with welded hard metal
ceramic coating (CC)

Identifying features:

- + black ceramic coating,
- + gold plated rings,
- + gold plated screw and
- + additionally the article number ends with the letter "C"

Hartmetall-SuperCut-Scheren mit Keramikbeschichtung (TC/MC/CC)

Schneiden mit aufgeschweißtem Hartmetall
unteres Blatt mit rasiermesserscharfer Schneide und oberes Blatt mikrofein gezahnt (MC)
Keramikbeschichtung (CC)

Erkennungsmerkmale:

- + schwarze Keramikbeschichtung,
- + lang vergoldete Ringe,
- + vergoldete Schraube und
- + **zusätzlich endet die Artikelnummer mit dem Buchstaben "N"**



Hard Metal SuperCut Scissors with Ceramic Coating (TC/MC/CC)

MA 1334-18N

blades with welded hard metal
lower blade with razor-sharp cutting edge and microfine serrated upper blade (MC)
ceramic coating (CC)

Identifying features:

- + *black ceramic coating,*
- + *long gold plated rings,*
- + *gold plated screw and*
- + *additionally the article number ends with the letter "N"*

Hartmetallschere mit Wellenschliff (TC/W)

Schneiden mit aufgeschweißtem Hartmetall
unteres Blatt mit feinem Wellenschliff (W)

Erkennungsmerkmale:

- + vergoldete Ringe und
- + **zusätzlich endet die Artikelnummer mit dem Buchstaben "W"**



Hard Metal Scissors with Wavecut (TC/W)

MA 1334-18W

blades with welded hard metal
lower blade with fine wavecut (W)

Identifying features:

- + *gold plated rings and*
- + *additionally the article number ends with the letter "W"*

Mikro-Federscheren Micro Spring Scissors

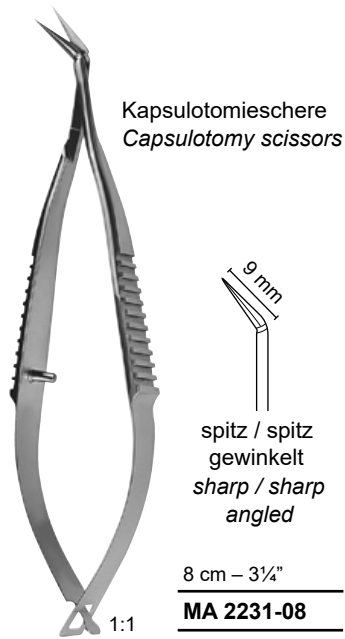

Kapsulotomieschere
Capsulotomy scissors

9 mm

spitz / spitz
gewinkelt
sharp / sharp
angled

8 cm - 3 1/4"

MA 2231-08

1:1

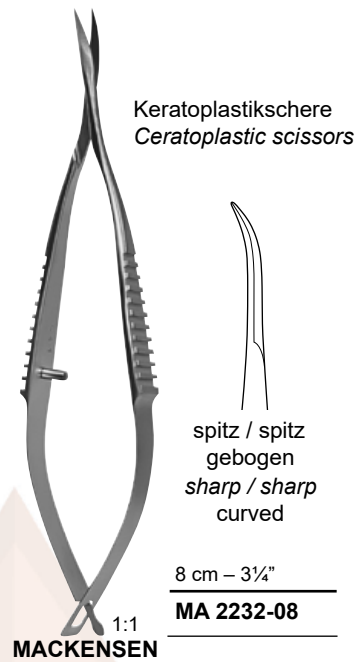

Keratoplastikschiere
Cerato-plastic scissors



spitz / spitz
gebogen
sharp / sharp
curved

8 cm - 3 1/4"

MA 2232-08

1:1

MACKENSEN



spitz / spitz
leicht gebogen
sharp / sharp
slightly curved

8 cm - 3 1/4"

MA 2233-04

1:1

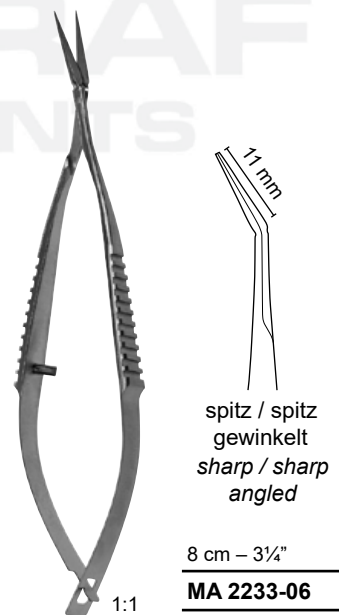

spitz / spitz
gewinkelt
sharp / sharp
angled

8 cm - 3 1/4"

MA 2233-06

1:1

Mikro-Federscheren Micro Spring Scissors



spitz / spitz
sharp / sharp



stumpf / spitz
blunt / sharp



stumpf / stumpf
blunt / blunt



spitz / stumpf
sharp / blunt

Blattlänge 7 mm
Length of blades 7 mm

11 cm – 4½"

Iridektomieschere
Iridectomy scissors

MA 2221-07	MA 2222-07	MA 2223-07	MA 2224-07
------------	------------	------------	------------



WECKER

gewinkelt
angled



spitz / spitz
sharp / sharp



stumpf / spitz
blunt / sharp



stumpf / stumpf
blunt / blunt



spitz / stumpf
sharp / blunt

Blattlänge 11 mm
Length of blades 11 mm

11 cm – 4½"

MA 2221-11	MA 2222-11	MA 2223-11	MA 2224-11
------------	------------	------------	------------

Iridektomieschere
Iridectomy scissors



NOYES



spitz / spitz
sharp / sharp

12 cm – 4¾"

MA 2200-01

Iridektomieschere
Iridectomy scissors



NOYES



spitz / spitz
gewinkelt
sharp / sharp
angled

12 cm – 4¾"

MA 2201-01

Mikro-Federscheren Micro Spring Scissors

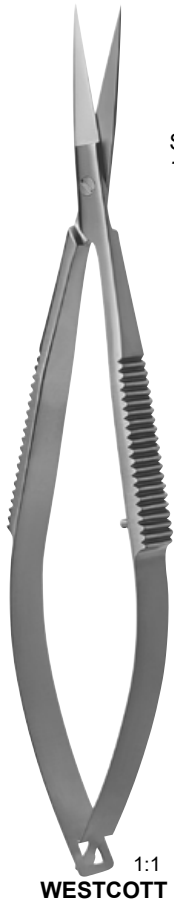

Sehnenschere
Tenotomy scissors

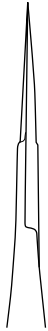

spitz / spitz
gerade
sharp / sharp
straight

11,5 cm – 4½"

MA 2240-11

1:1
WESTCOTT

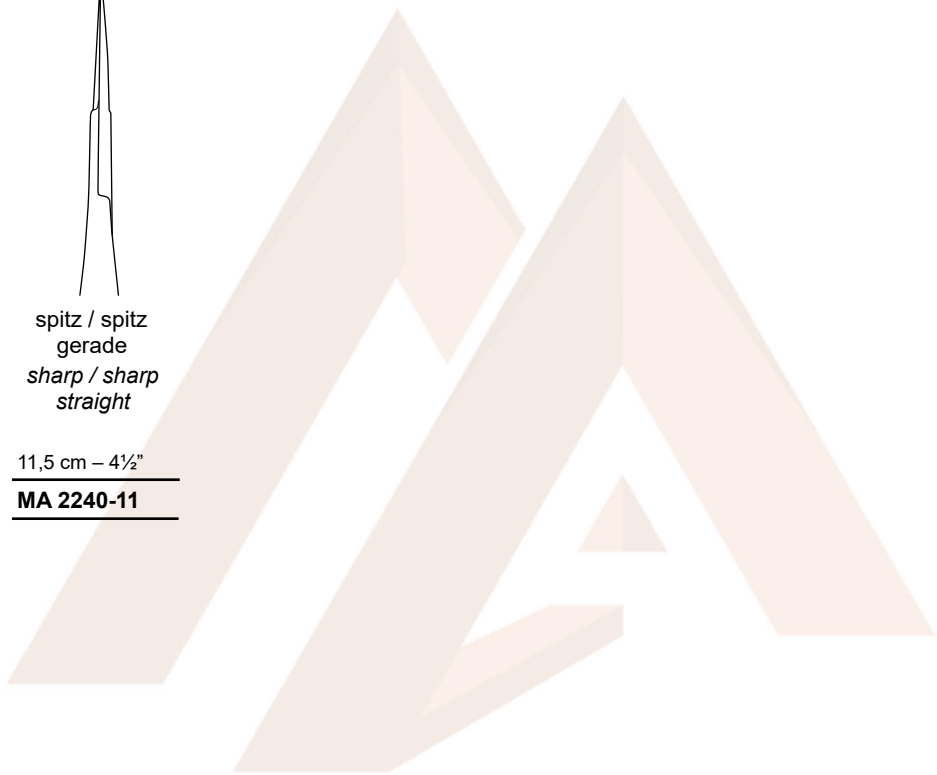

M.ASHRAF
INSTRUMENTS



Sehnenschere
Tenotomy scissors

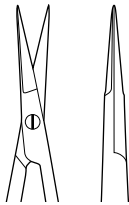

spitz / spitz
gerade
sharp / sharp
straight

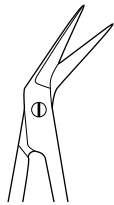

spitz / spitz
gewinkelt
sharp / sharp
angled

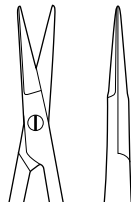

stumpf / stumpf
gerade
blunt / blunt
straight



stumpf / stumpf
gebogen
blunt / blunt
curved

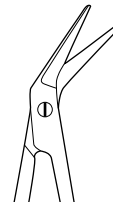

stumpf / stumpf
gewinkelt
blunt / blunt
angled

9,5 cm – 3¾"

1:1

MA 2244-09

MA 2248-09

MA 2246-09

MA 2247-09

MA 2250-09

Mikro-Federscheren Micro Spring Scissors



stumpf / stumpf
gerade
blunt / blunt
straight



stumpf / stumpf
gebogen
blunt / blunt
curved



spitz / spitz
gewinkelt
sharp / sharp
angled



stumpf / stumpf
gewinkelt
blunt / blunt
angled

8,5 cm – 3¼"

MA 2260-08

MA 2261-08

MA 2262-08

MA 2263-08



Nachstarschere
Secondary cataract scissors



stumpf / stumpf
gerade
blunt / blunt
straight



stumpf / stumpf
gebogen
blunt / blunt
curved



spitz / spitz
gewinkelt
sharp / sharp
angled



stumpf / stumpf
gewinkelt
blunt / blunt
angled

8,5 cm – 3¼"

MA 2270-08

MA 2271-08

MA 2272-08

MA 2273-08

VANNAS, MODELL TÜBINGEN
VANNAS, TUEBINGER PATTERN

Mikro-Federscheren Micro Spring Scissors



1:1
CASTROVIEJO

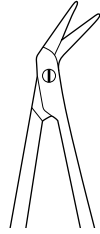

stumpf / stumpf
gewinkelt
blunt / blunt
angled

10 cm – 4"

MA 2286-10



1:1
CASTROVIEJO



spitz / spitz
gebogen
sharp / sharp
curved

10 cm – 4"

MA 2300-10



1:1
CASTROVIEJO



stumpf / stumpf
gebogen
blunt / blunt
curved

10 cm – 4"

MA 2310-10



1:1
TROUTMAN



rechts
right

10 cm – 4"

MA 2316-10

Hornhautschere
Corneal scissors

M.ASHRAF
INSTRUMENTS

Mikro-Federscheren Micro Spring Scissors



Hornhautschere
Corneal scissors



links
left

10 cm – 4"

MA 2338-10

1:1
CASTROVIEJO



Hornhautschere
Corneal scissors



rechts
right

10 cm – 4"

MA 2339-10

1:1
CASTROVIEJO



Hornhautschere
Corneal scissors



links
left

11 cm – 4¼"

MA 2345-11

1:1
CASTROVIEJO



Hornhautschere
Corneal scissors

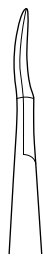

rechts
right

11 cm – 4¼"

MA 2340-11

1:1
CASTROVIEJO

Mikro-Federscheren Micro Spring Scissors



Sehnenschere
Tenotomy scissors

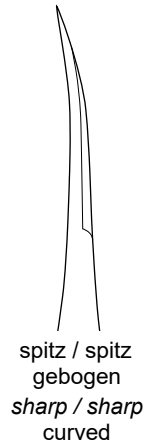

spitz / spitz
gebogen
*sharp / sharp
curved*

11 cm – 4¼"

MA 2330-11

1:1
WESTCOTT



Sehnenschere
Tenotomy scissors

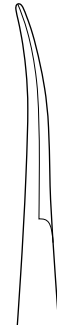

stumpf / stumpf
gebogen
*blunt / blunt
curved*

11 cm – 4¼"

MA 2335-11

1:1
WESTCOTT

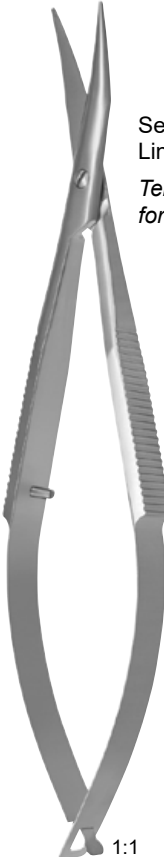

Sehnenschere für
Linkshänder
*Tenotomy scissors
for left-hander*



stumpf / stumpf
gebogen
*blunt / blunt
curved*

11 cm – 4¼"

MA 2336-11

1:1
WESTCOTT

M.ASHRAF
INSTRUMENTS

Mikro-Federscheren Micro Spring Scissors



1:1



gerade
straight



gebogen
curved

10,5 cm – 4¹/₄"

MA 2368-10

MA 2369-10



gerade
straight



gebogen
curved

12 cm – 4³/₄"

MA 2254-02

MA 2254-03

16 cm – 6¹/₄"

MA 2254-22

MA 2254-23

18,5 cm – 7¹/₄"

MA 2254-32

MA 2254-33

Venenschere

kein Abgleiten des Gefäßes
glatte, saubere Durchtrennung

Vein scissors

vessel cannot slip off
clean, smooth cut



BIEMER



13 cm – 5"

MA 2370-01

Mikro-Federscheren Micro Spring Scissors



STREAMLINE

durch den geschwungenen Schluss verfährt sich der Faden nicht mehr, sondern gleitet über die Oberfläche.

weniger Reparatur anfällig

because of the curved lock design the suture does not get caught and slides over the surface.

less prone to repairs

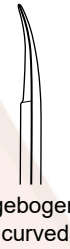

16,5 cm – 6½"	MA 2252-22	MA 2252-23	–
20 cm – 8"	MA 2252-42	MA 2252-43	MA 2252-41
22,5 cm – 9"	MA 2253-52	MA 2253-53	–
24,5 cm – 9¾"	MA 2253-62	MA 2253-63	–

 STREAMLINE	20 cm – 8"	MA 2252-42R	MA 2252-43R	–
	22,5 cm – 9"	MA 2253-52R	MA 2253-53R	–



16,5 cm – 6½"	MA 2252-28	–
18,5 cm – 7½"	MA 2252-38	–
20 cm – 8"	MA 2252-48	MA 2252-49
22,5 cm – 9"	MA 2253-58	MA 2253-59

 STREAMLINE	20 cm – 8"	MA 2252-48R	MA 2252-49R
	22,5 cm – 9"	MA 2253-58R	MA 2253-59R

Mikro-Federscheren Micro Spring Scissors

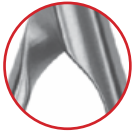

STREAMLINE

durch den geschwungenen Schluss verfängt sich der Faden nicht mehr, sondern gleitet über die Oberfläche.

weniger Reparatur anfällig

because of the curved lock design the suture does not get caught and slides over the surface.

less prone to repairs



gerade

gebogen-
curved

straight

 STREAMLINE	16 cm – 6¼"	MA 2370-16R	MA 2371-16R
	18 cm – 7"	MA 2370-18R	MA 2371-18R



gerade
straight

gebogen
curved

14 cm – 5½"	TI	MA 2380-14T	MA 2388-14T
-------------	-----------	--------------------	--------------------

 STREAMLINE	15 cm – 6"	MA 2380-16R	MA 2381-16R
--	------------	--------------------	--------------------

TI = Titan / Titanium

Mikro-Federscheren Micro Spring Scissors

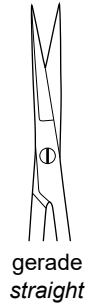

gerade
straight



gebogen
curved



gewinkelt
angled

18 cm – 7"

MA 2350-18	MA 2351-18	MA 2352-18
------------	------------	------------

JACOBSON



bajonettförmig
bayonet-shaped

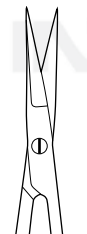

gerade
straight



gebogen
curved

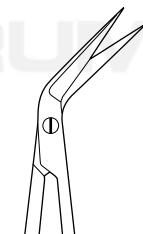

gewinkelt
angled

19 cm – 7½"

MA 2360-19	MA 2361-19	MA 2362-19
------------	------------	------------



gerade
straight

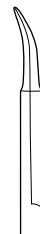

gebogen
curved

VANNAS

19 cm – 7½"	MA 2364-19	MA 2365-19
-------------	------------	------------

Mikro-Federscheren Micro Spring Scissors

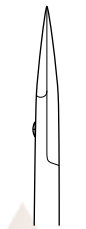

gerade
straight



gebogen
curved



gerade
straight

18,5 cm – 7¼"	TI	MA 2382-18T	MA 2383-18T	–
23 cm – 9"	TI	–	–	MA 2382-23T

Evolution / Nano

leichter als Titan dank neuem Griff-Design alle Vorzüge von Edelmetallinstrumenten außergewöhnlich gute Haptik für präzises Arbeiten problemloses Reinigen für bestmögliche Hygiene optimale Ergonomie dank der runden Griffschalen

Evolution / Nano

lighter than titanium thanks to the new handle design all advantages of stainless steel instruments unsurpassed haptic for precision during the operation easy cleaning for best possible hygiene optimal ergonomoy due to the round shell handles



Nano

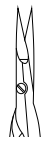

gerade
straight



gebogen
curved

15 cm – 6"

MA 2380-75	MA 2381-75
-------------------	-------------------



Evolution



gerade
straight



gebogen
curved







12 cm – 4¾"	MA 2380-82	MA 2381-82
15 cm – 6"	MA 2380-85	MA 2381-85
18 cm – 7"	MA 2380-88	MA 2381-88

Feine Scheren Delicate Scissors







Augenschere
Eye scissors

KNAPP

					
stumpf / stumpf blunt / blunt	spitz / stumpf sharp / blunt	spitz / spitz sharp / sharp	stumpf / stumpf blunt / blunt	spitz / stumpf sharp / blunt	spitz / spitz sharp / sharp
geradestraight			gebogencurved		
10,5 cm – 4¼"			10,5 cm – 4¼"		
MA 2404-01	MA 2404-02	MA 2404-03	MA 2405-01	MA 2405-02	MA 2405-03





Iris- und
Fadenschere
Iris and
suture scissors

			
gerade straight	gebogen curved	gerade straight	gebogen curved
MA 2420-09	MA 2421-09	MA 2422-09	MA 2423-09
9,5 cm – 3¾"			
10,5 cm – 4¼"	MA 2420-10	MA 2421-10	MA 2422-10
11,5 cm – 4½"	MA 2420-11	MA 2421-11	MA 2422-11

FINO



große Ringe
large rings

	
gerade straight	gebogen curved
10 cm – 4"	
MA 2426-10	MA 2427-10

Feine Scheren Delicate Scissors

Irisschere mit fl achen Branchen
Iris scissors »Ribbon Type«



spitz / spitz
sharp / sharp



gerade
straight



gebogen
curved

10 cm – 4"

MA 2473-02	MA 2473-03
-------------------	-------------------

Irisschere mit fl achen Branchen
Iris scissors »Ribbon Type«



stumpf / stumpf
blunt / blunt



gerade
straight



gebogen
curved

10 cm – 4"

MA 2474-02	MA 2474-03
-------------------	-------------------

Irisschere mit fl achen Branchen
Iris scissors »Ribbon Type«



spitz / spitz
sharp / sharp



gerade
straight



gebogen
curved

9,5 cm – 3¾"

MA 2476-02	MA 2476-03
-------------------	-------------------

Irisschere mit fl achen Branchen
Iris scissors »Ribbon Type«



stumpf / stumpf
blunt / blunt



gerade
straight



gebogen
curved

9,5 cm – 3¾"

MA 2477-02	MA 2477-03
-------------------	-------------------

Irisschere mit fl achen Branchen
Iris scissors »Ribbon Type«



spitz / spitz
sharp / sharp



gerade
straight



gebogen
curved

9,5 cm – 3¾"

MA 2478-02	MA 2478-03
-------------------	-------------------

Anatomie-Schere
Dissecting scissors



gerade
straight



gebogen
curved

11 cm – 4¼"

MA 2480-11	MA 2481-11
-------------------	-------------------

13 cm – 5"

MA 2480-13	MA 2481-13
-------------------	-------------------

Feine Scheren Delicate Scissors



spitz / spitz
sharp / sharp

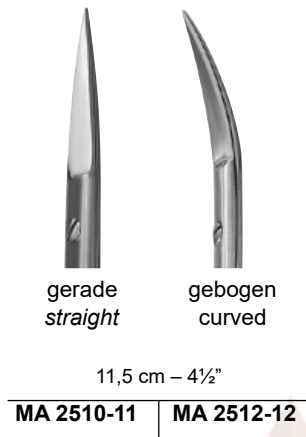

gerade
straight

gebogen
curved

11,5 cm – 4½"

MA 2510-11

MA 2512-12

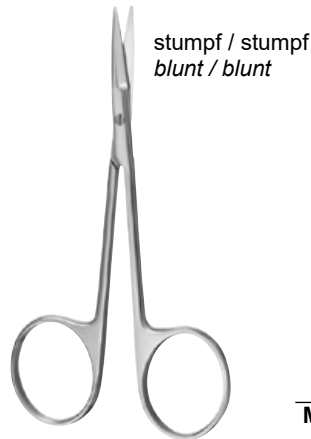

stumpf / stumpf
blunt / blunt

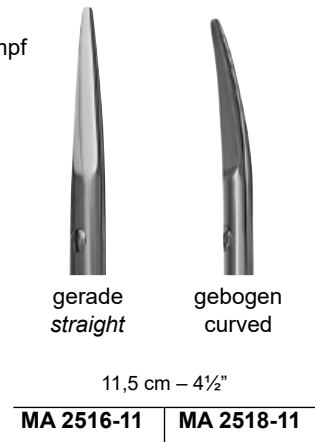

gerade
straight

gebogen
curved

11,5 cm – 4½"

MA 2516-11

MA 2518-11

Sehnenschere
Tenotomy scissors



stumpf / stumpf
blunt / blunt

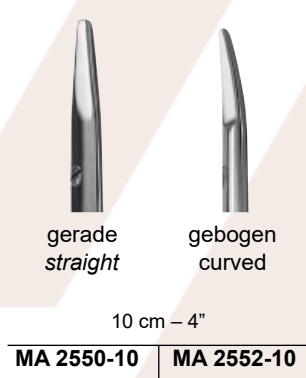

gerade
straight

gebogen
curved

10 cm – 4"

MA 2550-10

MA 2552-10

STEVENS

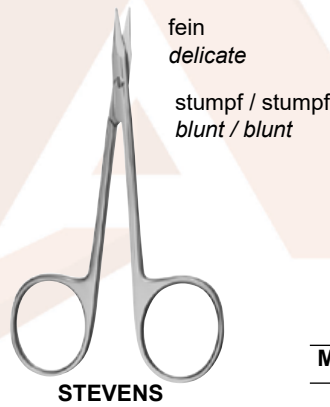

fein
delicate
stumpf / stumpf
blunt / blunt

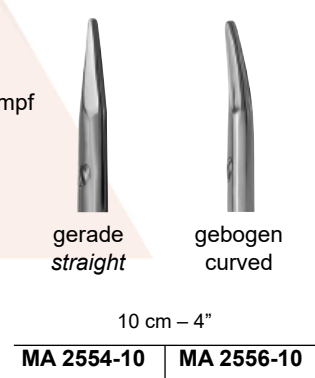

gerade
straight

gebogen
curved

10 cm – 4"

MA 2554-10

MA 2556-10

STEVENS

M.ASHRAF
INSTRUMENTS



gezahnt
saw edge



gebogen
curved

11,5 cm – 4½"

MA 2566-11

KAYE

Feine Scheren Delicate Scissors

Strabismus Scheren
Strabismus scissors



11,5 cm – 4½"

MA 2570-11	MA 2571-11	MA 2572-11
------------	------------	------------

Fadenschere
Stitch scissors



10 cm – 4"

MA 2595-10

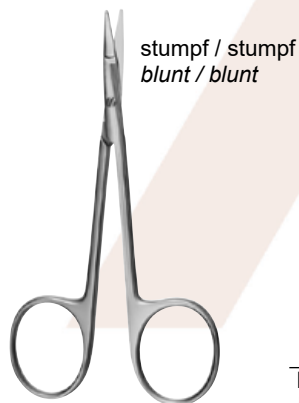

10,5 cm – 4¼"

MA 2584-10	MA 2585-10
------------	------------



10 cm – 4"

MA 2590-10	MA 2592-10
------------	------------

M.ASHRAF INSTRUMENTS

Irisschere, fein
Iris scissors, delicate



10 cm – 4"

MA 2596-10	MA 2597-10
------------	------------



11 cm – 4¼"

MA 2598-11	MA 2599-11
------------	------------

Feine Scheren Delicate Scissors



gerade
straight



gebogen
curved



Typ / Type	9 cm – 3½"	
	MA 1630-09	MA 1631-09
MC	MA 1630-09M	MA 1631-09M
CC	MA 1630-09C	MA 1631-09C
TC	MA 2406-09	MA 2407-09
TC/MC	MA 2406-09M	MA 2407-09M
TC/CC	MA 2406-09C	MA 2407-09C
TC/MC/CC	MA 2406-09N	MA 2407-09N



gerade
straight



gebogen
curved



extra fl ach
extra flat

Typ / Type	10,5 cm – 4¼"		
	MA 1630-10	MA 1631-10	MA 1632-10
CC	MA 1630-10C	MA 1631-10C	-



FINO



gerade
straight



gebogen
curved

10,5 cm – 4¼"	
MA 2418-10	MA 2419-10

MC = SuperCut-Schere / SuperCut scissors
TC = Hartmetallschere / hard metal scissors

CC = Keramikbeschichtete Schere / Ceramic coated scissors
W = Wellenschliff-Schere / Wavecut scissors

Feine Scheren Delicate Scissors



stumpf / stumpf
blunt / blunt



spitz / stumpf
sharp / blunt



stumpf / stumpf
blunt / blunt



spitz / stumpf
sharp / blunt

gerade
straight

gebogen
curved

11,5 cm – 4½"

11,5 cm – 4½"

MA 2396-01	MA 2396-02	MA 2397-01	MA 2397-02
-------------------	-------------------	-------------------	-------------------



gerade
straight



gebogen
curved



gewinkelt
angled



sichelförmig
sickle shaped

Typ / Type	11,5 cm – 4½"			
	MA 1630-11	MA 1631-11	MA 2414-11	MA 2416-11
MC	MA 1630-11M	MA 1631-11M	–	–
CC	MA 1630-11C	MA 1631-11C	–	–
MC/CC	MA 1630-11N	MA 1631-11N	–	–
TC	MA 2406-11	MA 2407-11	–	–
TC/MC	MA 2406-11M	MA 2407-11M	–	–
TC/CC	MA 2406-11C	MA 2407-11C	–	–
TC/MC/CC	MA 2406-11N	MA 2407-11N	–	–



gerade
straight



gebogen
curved

11,5 cm – 4½"

MA 2418-11	MA 2419-11
-------------------	-------------------

FINO



MC = SuperCut-Schere / SuperCut scissors TC
= Hartmetallschere / hard metal scissors

CC = Keramikbeschichtete Schere / Ceramic coated scissors W
= Wellenschliff-Schere / Wavecut scissors

Feine Scheren
Delicate Scissors



gewinkelt
angled

9 cm – 3½"

MA 1636-09



gebogen
curved

10 cm – 4"

MA 1638-10

WALTON



gerade
straight

14,5 cm – 5¾"

MA 1640-14

SANVENERO



gebogen
curved

14,5 cm – 5¾"

MA 1641-14

SANVENERO

Feine chirurgische Scheren Delicate Surgical Scissors



stumpf / stumpf
blunt / blunt

spitz / stumpf
sharp / blunt

Fig. 1

Fig. 2

	gerade- straight	gebogen- curved	gerade- straight	gebogen- curved
12 cm – 4¾"	MA 1501-12	MA 1511-12	MA 1502-12	MA 1512-12



spitz / spitz
sharp / sharp

Fig. 3

	Typ Type	gerade- straight	gebogen- curved
12 cm – 4¾"		MA 1503-12	MA 1513-12
	MC	MA 1503-12M	MA 1513-12M

Feine chirurgische Scheren Delicate Surgical Scissors



stumpf / stumpf
blunt / blunt

spitz / stumpf
sharp / blunt

Fig. 1

Fig. 2

	gerade- straight	gebogen- curved	gerade- straight	gebogen- curved
12 cm – 4¾"	MA 1521-12	MA 1524-12	MA 1522-12	MA 1525-12



spitz / spitz
sharp / sharp

Fig. 3

	Typ Type	gerade- straight	gebogen- curved
12 cm – 4¾"		MA 1523-12	MA 1526-12
	MC	MA 1523-12M	MA 1526-12M

MC = SuperCut-Schere / SuperCut scissors TC
= Hartmetallschere / hard metal scissors

CC = Keramikbeschichtete Schere / Ceramic coated scissors W
= Wellenschliff-Schere / Wavecut scissors

Feine chirurgische Scheren Delicate Surgical Scissors



BROPHY (SULLIVAN)



spitz / spitz
sharp / sharp

gerade-
straight

14,5 cm – 5¾"

MA 1550-14



BROPHY (SULLIVAN)



spitz / spitz
sharp / sharp

gebogen-
curved

14,5 cm – 5¾"

MA 1551-14

Chirurgische Scheren Surgical Scissors



stumpf / stumpf
blunt / blunt
gerade / straight



stumpf / stumpf
blunt / blunt gebogen / curved

	Typ Type	geradestraight	gebogencurved
10,5 cm – 4¼"		MA 1001-10	MA 1011-10
11,5 cm – 4½"		MA 1001-11	MA 1011-11
13 cm – 5"		MA 1001-13	MA 1011-13
14,5 cm – 5¾"		MA 1001-14	MA 1011-14
	TC	MA 1004-14	MA 1014-14
	TC/CC	MA 1004-14C	MA 1014-14C
15,5 cm – 6"		MA 1001-15	MA 1011-15
16,5 cm – 6½"		MA 1001-16	MA 1011-16
17,5 cm – 7"		MA 1001-17	MA 1011-17
18,5 cm – 7"		MA 1001-18	MA 1011-18
20 cm – 8"		MA 1001-20	MA 1011-20



spitz / stumpf
sharp / blunt
gerade / straight



spitz / stumpf
sharp / blunt gebogen / curved

	Typ Type	geradestraight	gebogencurved
10,5 cm – 4¼"		MA 1002-10	MA 1012-10
11,5 cm – 4½"		MA 1002-11	MA 1012-11
13 cm – 5"		MA 1002-13	MA 1012-13
14,5 cm – 5¾"		MA 1002-14	MA 1012-14
	MC	MA 1002-14M	MA 1012-14M
	CC	MA 1002-14C	MA 1012-14C
	MC/CC	MA 1002-14N	MA 1012-14N
	TC	MA 1006-14	MA 1016-14
	TC/CC	MA 1006-14C	MA 1016-14C
15,5 cm – 6"		MA 1002-15	MA 1012-15
16,5 cm – 6½"		MA 1002-16	MA 1012-16
17,5 cm – 7"		MA 1002-17	MA 1012-17
18,5 cm – 7¼"		MA 1002-18	MA 1012-18
20 cm – 8"		MA 1002-20	MA 1012-20

MC = SuperCut-Schere / SuperCut scissors
TC = Hartmetallschere / hard metal scissors

CC = Keramikbeschichtete Schere / Ceramic coated scissors
W = Wellenschliff-Schere / Wavecut scissors

Chirurgische Scheren Surgical Scissors



spitz / spitz
sharp / sharp
gerade / straight



spitz / spitz
sharp / sharp gebogen / curved

	Typ Type	geradestraight	gebogencurved
10,5 cm – 4¼"		MA 1003-10	MA 1013-10
11,5 cm – 4½"		MA 1003-11	MA 1013-11
13 cm – 5"		MA 1003-13	MA 1013-13
14,5 cm – 5¾"		MA 1003-14	MA 1013-14
	TC	MA 1008-14	MA 1018-14
	TC/CC	MA 1008-14C	MA 1018-14C
15,5 cm – 6"		MA 1003-15	MA 1013-15
16,5 cm – 6½"		MA 1003-16	MA 1013-16
17,5 cm – 7"		MA 1003-17	MA 1013-17
18,5 cm – 7¼"		MA 1003-18	MA 1013-18
20 cm – 8"		MA 1003-20	MA 1013-20



schlankes Modell
slender pattern



stumpf / stumpf
blunt / blunt

spitz / stumpf
sharp / blunt

spitz / spitz
sharp / sharp

gerade
straight

gebogen
curved

gerade
straight

gebogen
curved

gerade
straight

gebogen
curved

13 cm – 5"	MA 1021-13	MA 1031-13	MA 1022-13	MA 1032-13	MA 1023-13	MA 1033-13
14,5 cm – 5¾"	MA 1021-14	MA 1031-14	MA 1022-14	MA 1032-14	MA 1023-14	MA 1033-14

Chirurgische Scheren Surgical Scissors



große Ringe
large rings

RUDOLF



spitz / stumpf
gerade
sharp / blunt
straight

14,5 cm – 5¾"
MA 1000-14



große Ringe
large rings

RUDOLF



spitz / stumpf
gebogen
sharp / blunt
curved

14,5 cm – 5¾"
MA 1010-14



DEAVER



spitz / stumpf
sharp / blunt

gerade
straight



gebogen
curved

14,5 cm – 5¾" | **MA 1040-14** | **MA 1041-14**

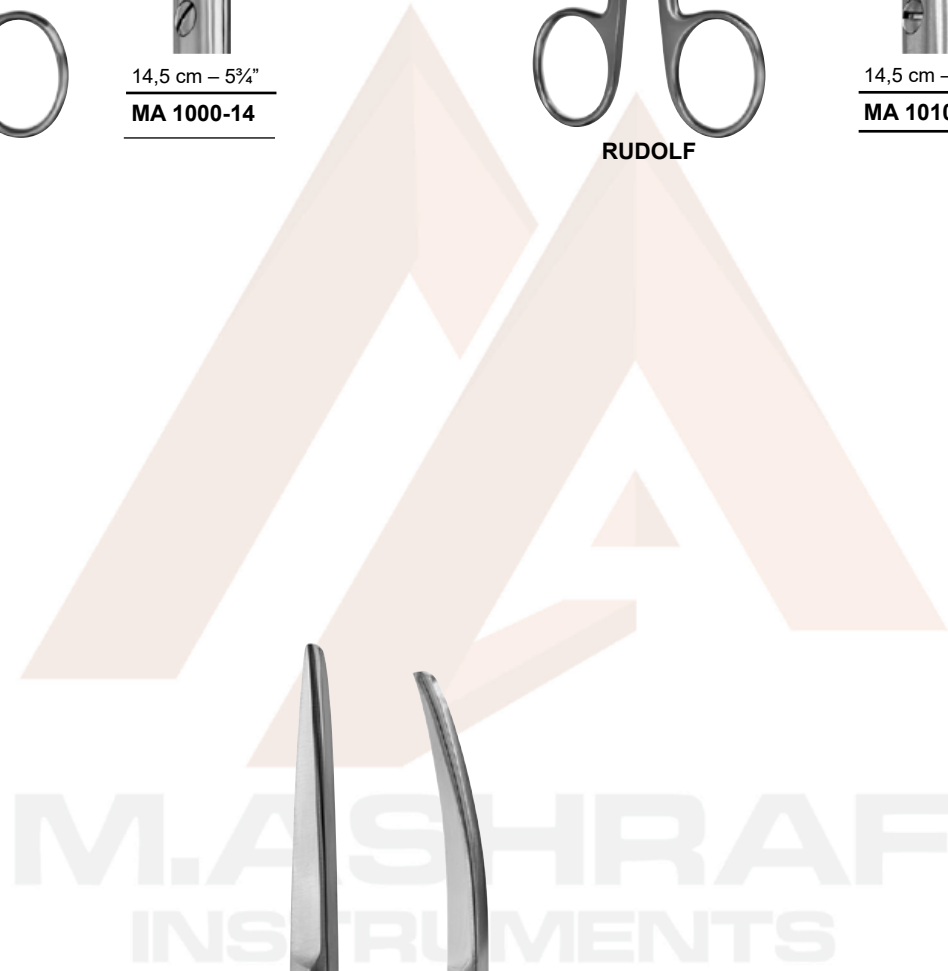

Chirurgische Scheren Surgical Scissors



Inzisionsschere
Incision scissors



geradestraight

13 cm – 5"	MA 1110-13
14,5 cm – 5¾"	MA 1110-14
16,5 cm – 6½"	MA 1110-16



Inzisionsschere
Incision scissors



*gerade
straight*

15,5 cm – 6"
MA 1112-15

Chirurgische Scheren Surgical Scissors



spitz / stumpf
seitwärts gewinkelt
*sharp / blunt angled
to side*



14,5 cm – 5¾"

MA 1120-14

RICHTER



stumpf / stumpf seit-
wärts gewinkelt *blunt
/ blunt angled to side*



14,5 cm – 5¾"

MA 1122-14

RICHTER



spitz / spitz
gebogen *sharp
/ sharp curved*



14,5 cm – 5¾"

MA 1132-14

NEW SUTURE



spitz / spitz
gebogen *sharp
/ sharp curved*



18,5 cm – 7¼"

MA 1130-18

FERGUSSON

Feine Präparierscheren Delicate Dissecting Scissors



Sehnenschere
Tenotomy scissors

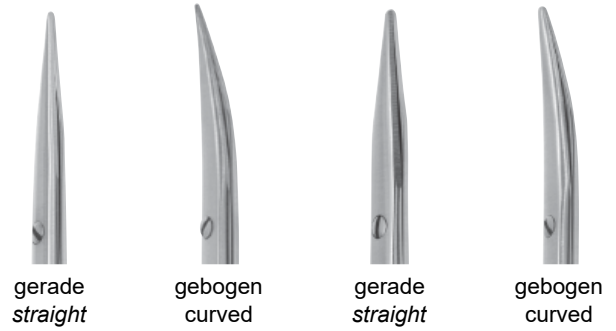

gerade
straight

gebogen
curved

gerade
straight

gebogen
curved

Typ Type		spitzsharp		stumpfbunt	
10,5 cm – 4¼"		MA 2430-10	MA 2431-10	MA 2440-10	MA 2441-10
	MC	–	–	MA 2440-10M	MA 2441-10M
11,5 cm – 4½"		MA 2430-11	MA 2431-11	MA 2440-11	MA 2441-11
	MC	MA 2430-11M	MA 2431-11M	MA 2440-11M	MA 2441-11M
	CC	–	–	MA 2440-11C	MA 2441-11C
	TC	–	–	MA 2440-51	MA 2441-51



Sehnenschere
Tenotomy scissors



stumpf / stumpf
gebogen
blunt / blunt
curved

12,5 cm – 5"

MA 2433-12

KLEINERT-KUTZ



Sehnenschere
Tenotomy scissors

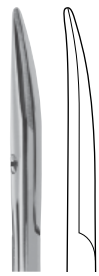

leicht gebogen,
stumpf
slightly curved,
blunt

Typ / Type | 9,5 cm – 3¾"

MC | MA 2441-09M

STEVENS- RUDOLF



MC = SuperCut-Schere / SuperCut scissors TC
= Hartmetallschere / hard metal scissors

CC = Keramikbeschichtete Schere / Ceramic coated scissors W
= Wellenschliff-Schere / Wavecut scissors

Feine Präparierscheren Delicate Dissecting Scissors



**MODELL BONN
BONN PATTERN**



gerade
straight



gebogen
curved

Typ / Type	8 cm – 3¼"	
	MA 2450-08	MA 2451-08
MC	MA 2450-08M	MA 2451-08M



GRAEFE



gewinkelt
angled

10,5 cm – 4¼"
MA 2455-10



WILMER



gewinkelt
angled

Typ / Type	10 cm – 4"
	MA 2457-10

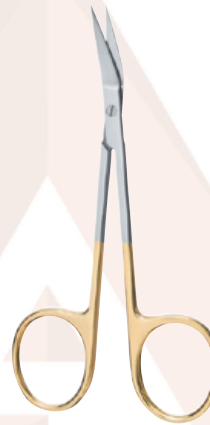

WILMER



gewinkelt
angled

Typ / Type	11,5 cm – 4½"
TC	MA 2458-10



Strabismusschere
Strabismus scissors



gerade
straight



gebogen
curved

Typ / Type	11,5 cm – 4½"	
	MA 2460-11	MA 2461-11
CC	MA 2460-11C	MA 2461-11C
TC	MA 2462-11	MA 2463-11
TC/MC	MA 2462-11M	MA 2463-11M
TC/CC	MA 2462-11C	MA 2463-11C
TC/MC/CC	–	MA 2463-11N
TC/W	MA 2462-11W	MA 2463-11W

MC = SuperCut-Schere / *SuperCut scissors*
= Hartmetallschere / *hard metal scissors*

CC = Keramikbeschichtete Schere / *Ceramic coated scissors*
= Wellenschliff-Schere / *Wavecut scissors*

Feine Präparierscheren Delicate Dissecting Scissors



GOLDMANN-FOX

oberes Blatt
mikrofein gezahnt
micro serrated
upper blade

Zahnfleischschere
Gum scissors



gerade
straight

gebogen
curved

13 cm – 5"

MA 2900-13	MA 2901-13
-------------------	-------------------



GOLDMANN-FOX

oberes Blatt
mikrofein gezahnt
micro serrated
upper blade



gerade
straight

gebogen
curved

Typ / Type	13 cm – 5"	
TC	MA 2902-13	MA 2903-13



MC = SuperCut-Schere / *SuperCut scissors* TC
= Hartmetallschere / *hard metal scissors*

CC = Keramikbeschichtete Schere / *Ceramic coated scissors* W
= Wellenschliff-Schere / *Wavecut scissors*

Feine Präparierscheren Delicate Dissecting Scissors

gebogen
curved

Typ / Type	13 cm – 5"
MC	MA 2901-13M
MC/CC	MA 2901-13N
TC/MC	MA 2903-13M

GOLDMANN-FOX

oberes Blatt
mikrofein gezahnt
*micro serrated
upper blade*

S-gebogen
S-curved

gerade
straight

13 cm – 5"
MA 2905-13

GOLDMANN-FOX (SPEZIAL)

S-gebogen
S-curved

gerade
straight

Typ / Type	13 cm – 5"
MC	MA 2905-13M

GOLDMANN-FOX (SPEZIAL)

MC = SuperCut-Schere / *SuperCut scissors* TC
= Hartmetallschere / *hard metal scissors*

CC = Keramikbeschichtete Schere / *Ceramic coated scissors* W
= Wellenschliff-Schere / *Wavecut scissors*

Feine Präparierscheren Delicate Dissecting Scissors



REYNOLDS

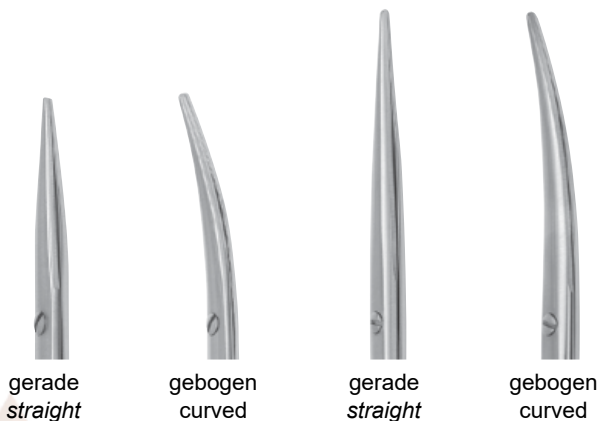

gerade
straight

gebogen
curved

gerade
straight

gebogen
curved

Typ / Type	15,5 cm – 6"		18 cm – 7"	
	MA 1580-15	MA 1581-15	MA 1580-18	MA 1581-18
MC	MA 1580-15M	MA 1582-15M	–	MA 1581-18M
CC	–	MA 1581-15C	–	MA 1581-18C



JAMESON



Typ / Type	14,5 cm – 5¾"	18 cm – 7"
	MA 1583-15	–
MC	MA 1583-15M	MA 1583-18M
CC	MA 1583-15C	–

Feine Präparierscheren Delicate Dissecting Scissors



JAMESON-WERBER



Typ / Type	13 cm – 5"	15 cm – 6"
	MA 1584-13	MA 1584-15
MC	MA 1584-13M	MA 1584-25M
CC	–	MA 1584-25C

M.ASHRAF
INSTRUMENTS

MC = SuperCut-Schere / SuperCut scissors
TC = Hartmetallschere / hard metal scissors

CC = Keramikbeschichtete Schere / Ceramic coated scissors W
= Wellenschliff-Schere / Wavecut scissors

Enucleationsscheren Enucleation Scissors



Präparierscheren Dissecting Scissors



LEXER



gerade
straight

gebogen
curved

Typ / Type	16 cm – 6¼"	
	MA 1100-16	MA 1101-16
MC	MA 1100-16M	MA 1101-16M
TC	MA 1102-16	MA 1103-16
TC/MC	MA 1102-16M	MA 1103-16M
TC/CC	–	MA 1103-16C
TC/W	–	MA 1103-16W



LEXER-FINO



gerade
straight

gebogen
curved

Typ / Type	16 cm – 6¼"	
	MA 1104-16	MA 1105-16
TC	MA 1106-16	MA 1107-16
TC/CC	–	MA 1107-16C
TC/W	–	MA 1107-16W

MC = SuperCut-Schere / SuperCut scissors
TC = Hartmetallschere / hard metal scissors

CC = Keramikbeschichtete Schere / Ceramic coated scissors
W = Wellenschliff-Schere / Wavecut scissors

Präparierscheren Dissecting Scissors



gerade
straight

MAYO



Typ / Type	14,5 cm – 5¾"	15 cm – 6"	17 cm – 6¾"
	MA 1250-14	MA 1250-15	MA 1250-17
MC	MA 1250-14M	–	MA 1250-17M
CC	MA 1250-14C	–	MA 1250-17C
TC	MA 1252-14	–	MA 1252-17
TC/MC	MA 1252-14M	–	MA 1252-17M
TC/CC	MA 1252-14C	–	MA 1252-17C



gerade
straight

MAYO



Typ / Type	20 cm – 8"	23 cm – 9"	28 cm – 11"
	MA 1250-20	MA 1250-23	MA 1250-28
MC	–	MA 1250-23M	MA 1250-28M
CC	–	MA 1250-23C	–
TC	–	MA 1252-23	–
TC/MC	–	MA 1252-23M	–
TC/CC	–	MA 1252-23C	–



MC = SuperCut-Schere / SuperCut scissors
TC = Hartmetallschere / hard metal scissors

CC = Keramikbeschichtete Schere / Ceramic coated scissors
W = Wellenschliff-Schere / Wavecut scissors

Präparierscheren Dissecting Scissors



gebogen
curved

MAYO



Typ / Type	14 cm – 5½"	15 cm – 6"	17 cm – 6¾"
	MA 1251-14	MA 1251-15	MA 1251-17
MC	MA 1251-14M	–	MA 1251-17M
CC	MA 1251-14C	–	MA 1251-17C
TC	MA 1253-14	–	MA 1253-17
TC/MC	MA 1253-14M	–	MA 1253-17M
TC/CC	MA 1253-14C	–	MA 1253-17C



gebogen
curved

MAYO



Typ / Type	20 cm – 8"	23 cm – 9"	28 cm – 11"
	MA 1251-20	MA 1251-23	MA 1251-28
MC	–	MA 1251-23M	MA 1251-28M
CC	–	MA 1251-23C	–
TC	–	MA 1253-23	–
TC/MC	–	MA 1253-23M	–
TC/CC	–	MA 1253-23C	–

MC = SuperCut-Schere / SuperCut scissors
TC = Hartmetallschere / hard metal scissors

CC = Keramikbeschichtete Schere / Ceramic coated scissors
W = Wellenschliff-Schere / Wavecut scissors

Präparierscheren Dissecting Scissors



MAYO-STILLE



gerade
straight

Typ / Type	14,5 cm – 5¾"	17 cm – 6¾"	19 cm – 7½"
	MA 1260-15	MA 1260-17	MA 1260-19
MC	MA 1260-15M	MA 1260-17M	–
CC	MA 1260-15C	MA 1260-17C	–
TC	MA 1262-15	MA 1262-17	–
TC/MC	MA 1262-15M	MA 1262-17M	–
TC/CC	MA 1262-15C	MA 1262-17C	–



MAYO-STILLE



gebogen
curved

Typ / Type	14,5 cm – 5¾"	17 cm – 6¾"	19 cm – 7½"	21 cm – 8¼"
	MA 1261-15	MA 1261-17	MA 1261-19	MA 1261-21
MC	MA 1261-15M	MA 1261-17M	–	–
CC	MA 1261-15C	MA 1261-17C	–	–
TC	MA 1263-15	MA 1263-17	–	–
TC/MC	MA 1263-15M	MA 1263-17M	–	–
TC/CC	MA 1263-15C	MA 1263-17C	–	–



MC = SuperCut-Schere / *SuperCut scissors*
TC = Hartmetallschere / *hard metal scissors*

CC = Keramikbeschichtete Schere / *Ceramic coated scissors* W
= Wellenschliff-Schere / *Wavecut scissors*

Präparierscheren Dissecting Scissors



MAYO-NOBLE



gerade
straight

17 cm – 6¾"

MA 1270-17



MAYO-NOBLE



gebogen
curved

17 cm – 6¾"

MA 1271-17



BABY-METZENBAUM



gerade
straight



gebogen
curved



gerade
straight



gebogen
curved

Typ / Type	9 cm – 3½"		11,5 cm – 4½"	
	–	–	MA 1280-11	MA 1281-11
MC	–	–	MA 1280-11M	MA 1281-11M
CC	–	–	MA 1280-11C	MA 1281-11C
TC	MA 1280-49	MA 1281-49	MA 1280-51	MA 1281-51

MC = SuperCut-Schere / SuperCut scissors TC
= Hartmetallschere / hard metal scissors

CC = Keramikbeschichtete Schere / Ceramic coated scissors W
= Wellenschliff-Schere / Wavecut scissors

Präparierscheren Dissecting Scissors



METZENBAUM-FINO



stumpf / stumpf
blunt / blunt

spitz / spitz
sharp / sharp

gerade
straight

gebogen
curved

gerade
straight

gebogen
curved

Typ / Type	14,5 cm – 5¾"			
	MA 1290-14	MA 1291-14	MA 1292-14	MA 1293-14
MC	MA 1290-14M	MA 1291-14M	–	–
CC	MA 1290-14C	MA 1291-14C	–	–
TC	MA 1306-14	MA 1316-14	–	MA 1318-14
TC/MC	MA 1306-14M	MA 1316-14M	–	–
TC/CC	MA 1306-14C	MA 1316-14C	–	MA 1318-14C



METZENBAUM



stumpf / stumpf
blunt / blunt

gebogen
curved

gerade
straight

gebogen
curved

Typ / Type	13 cm – 5"	14,5 cm – 5¾"	
	MA 1311-13	MA 1301-14	MA 1311-14
MC	–	MA 1301-14M	MA 1311-14M
CC	–	MA 1301-14C	MA 1311-14C
TC	–	MA 1304-14	MA 1314-14
		–	MA 1314-14RS
TC/MC	–	MA 1304-14M	MA 1314-14M
TC/CC	–	MA 1304-14C	MA 1314-14C
TC/MC/CC	–	–	MA 1314-14N



MC = SuperCut-Schere / SuperCut scissors
= Hartmetallschere / hard metal scissors
RS = gezahnt / serrated

CC = Keramikbeschichtete Schere / Ceramic coated scissors
W = Wellenschliff-Schere / Wavecut scissors

Präparierscheren Dissecting Scissors



METZENBAUM



spitz / stumpf
sharp / blunt

gerade
straight



gebogen
curved



spitz / spitz
sharp / sharp

gerade
straight



gebogen
curved

Typ / Type	14,5 cm – 5¾"			
	MA 1302-14	MA 1312-14	MA 1303-14	MA 1313-14
TC	–	–	MA 1308-14	–
TC/CC	–	–	MA 1308-14C	–

M.ASHRAF
INSTRUMENTS

MC = SuperCut-Schere / SuperCut scissors TC
= Hartmetallschere / hard metal scissors

CC = Keramikbeschichtete Schere / Ceramic coated scissors W
= Wellenschliff-Schere / Wavecut scissors

Präparierscheren Dissecting Scissors



METZENBAUM-FINO

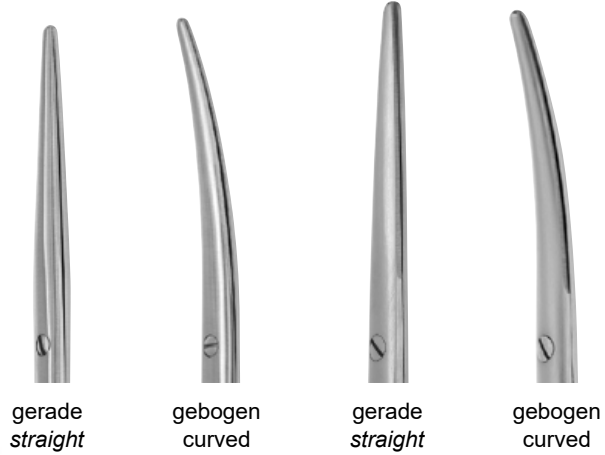

gerade
straight

gebogen
curved

gerade
straight

gebogen
curved

Typ / Type	18 cm – 7"		20 cm – 8"	
	MA 1320-18	MA 1330-18	MA 1320-20	MA 1330-20
MC	MA 1320-18M	MA 1330-18M	–	MA 1330-20M
CC	MA 1320-18C	MA 1330-18C	–	–
TC	MA 1326-18	MA 1336-18	MA 1326-20	MA 1336-20
TC/MC	MA 1326-18M	MA 1336-18M	–	MA 1336-20M
TC/CC	MA 1326-18C	MA 1336-18C	MA 1326-20C	MA 1336-20C



METZENBAUM



gerade
straight

gebogen
curved

gerade
straight

gebogen
curved

Typ / Type	18 cm – 7"		20 cm – 8"	
	MA 1321-18	MA 1331-18	MA 1321-20	MA 1331-20
MC	MA 1321-18M	MA 1331-18M	MA 1321-20M	MA 1331-20M
CC	MA 1321-18C	MA 1331-18C	–	MA 1331-20C
MC/CC	–	MA 1331-18N	–	–
TC	MA 1324-18	MA 1334-18	MA 1324-20	MA 1334-20
TC/MC	MA 1324-18M	MA 1334-18M	–	MA 1334-20M
TC/MC/CC	–	MA 1334-18N	–	–
TC/CC	MA 1324-18C	MA 1334-18C	MA 1324-20C	MA 1334-20C
TC/W	–	MA 1334-18W	–	–



MC = SuperCut-Schere / SuperCut scissors
TC = Hartmetallschere / hard metal scissors

CC = Keramikbeschichtete Schere / Ceramic coated scissors
W = Wellenschliff-Schere / Wavecut scissors

Präparierscheren Dissecting Scissors



METZENBAUM



gebogen
curved

18 cm – 7"

MA 1331-18S



METZENBAUM-FINO



gerade
straight



gebogen
curved



gerade
straight



gebogen
curved



gebogen
curved

Typ / Type	23 cm – 9"		25 cm – 10"		28 cm – 11"
	MA 1320-23	MA 1330-23	MA 1320-25	MA 1330-25	MA 1330-28
MC	–	MA 1330-23M	–	–	–
CC	MA 1320-23C	MA 1330-23C	–	–	–
TC	MA 1326-23	MA 1336-23	MA 1326-25	MA 1336-25	MA 1336-28
TC/MC	MA 1326-23M	MA 1336-23M	–	MA 1336-25M	–
TC/CC	MA 1326-23C	MA 1336-23C	–	–	–

MC = SuperCut-Schere / *SuperCut scissors* TC
= Hartmetallschere / *hard metal scissors* RS =
gezahnt / *serrated*

CC = Keramikbeschichtete Schere / *Ceramic coated scissors* W
= Wellenschliff-Schere / *Wavecut scissors*
S = Supreme

Präparierscheren Dissecting Scissors

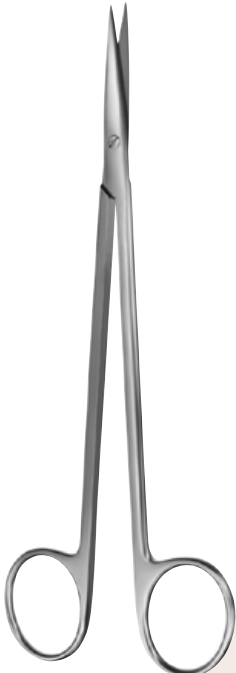

METZENBAUM



spitz / spitz
sharp / sharp

gerade
straight

gebogen
curved

18 cm – 7"	MA 1323-18	MA 1333-18
20 cm – 8"	MA 1323-20	MA 1333-20
23 cm – 9"	MA 1323-23	MA 1333-23



METZENBAUM



spitz / spitz
sharp / sharp

	Typ Type	gerade- straight	gebogen- curved
18 cm – 7"	TC	MA 1328-18	MA 1338-18
20 cm – 8"	TC	MA 1328-20	MA 1338-20
23 cm – 9"	TC	MA 1328-23	MA 1338-23



MC = SuperCut-Schere / *SuperCut scissors*
TC = Hartmetallschere / *hard metal scissors*

CC = Keramikbeschichtete Schere / *Ceramic coated scissors*
W = Wellenschliff-Schere / *Wavecut scissors*

Präparierscheren Dissecting Scissors



METZENBAUM



gerade
straight



gebogen
curved



gerade
straight



gebogen
curved

Typ / Type	23 cm – 9"		25 cm – 10"	
	MA 1321-23	MA 1331-23	MA 1321-25	MA 1331-25
MC	MA 1321-23M	MA 1331-23M	–	MA 1331-25M
CC	MA 1321-23C	MA 1331-23C	–	–
TC	MA 1324-23	MA 1334-23	–	MA 1334-25
TC/MC	MA 1324-23M	MA 1334-23M	–	–
TC/CC	MA 1324-23C	MA 1334-23C	–	–

M.ASHRAF
INSTRUMENTS

MC = SuperCut-Schere / SuperCut scissors
TC = Hartmetallschere / hard metal scissors

CC = Keramikbeschichtete Schere / Ceramic coated scissors
W = Wellenschliff-Schere / Wavecut scissors

Präparierscheren Dissecting Scissors



METZENBAUM



gerade
straight



gebogen
curved



gerade
straight



gebogen
curved

Typ / Type	28 cm – 11"		30 cm – 11¾"	
	MA 1321-28	MA 1331-28	MA 1321-30	MA 1331-30
MC	–	MA 1331-28M	–	MA 1331-30M
TC	–	MA 1334-28	–	MA 1334-30

M.ASHRAF
INSTRUMENTS



MC = SuperCut-Schere / *SuperCut scissors* TC
= Hartmetallschere / *hard metal scissors*

CC = Keramikbeschichtete Schere / *Ceramic coated scissors* W
= Wellenschliff-Schere / *Wavecut scissors*

Präparierscheren Dissecting Scissors



METZENBAUM-S



S-gebogen
S-curved



Typ / Type	14 cm – 5½"	18 cm – 7"	20 cm – 8"	23 cm – 9"	25 cm – 10"
TC	MA 1339-15	MA 1339-18	MA 1339-20	MA 1339-23	MA 1339-26

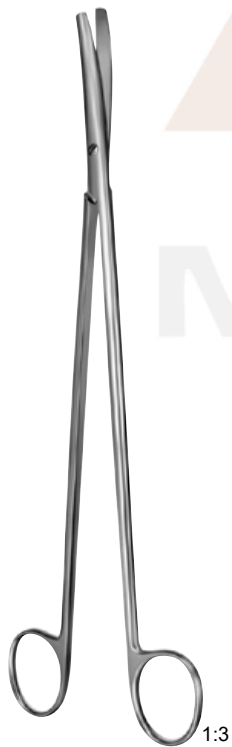

WELLER



gebogen
curved

28 cm – 11"

MA 1350-28

MC = S uperCut-Schere / *SuperCut scissors* TC
= Hartmetallschere / *hard metal scissors*

CC = Keramikbeschichtete Schere / *Ceramic coated scissors* W
= Wellenschliff-Schere / *Wavecut scissors*

Facelift- und Nasenscheren Facelift and Nasal Scissors



BABY-LEXER (KNAPP)



gerade
straight



gebogen
curved

10 cm – 4"

MA 1650-10

MA 1651-10



gerade
straight



gebogen
curved

13 cm – 5"

MA 1654-13

MA 1655-13

Facelift- und Nasenscheren Facelift and Nasal Scissors



Blepharoplastik Schere
Blepharoplasty scissors



gebogen
curved

Typ / Type	11,5 cm – 4½"
TC/MC	MA 1659-61M
TC/W	MA 1659-61W



KAYE



gebogen
curved

Typ / Type	11,5 cm – 4½"
MC	MA 1661-11M
TC/W	MA 1661-61W

M.ASHRAF
INSTRUMENTS



GREENBERG-PAR



gerade
straight



gebogen
curved

Typ / Type	11,5 cm – 4½"	
TC/W	MA 1662-61W	MA 1663-61W

MC = SuperCut-Schere / SuperCut scissors TC
= Hartmetallschere / hard metal scissors

CC = Keramikbeschichtete Schere / Ceramic coated scissors W
= Wellenschliff-Schere / Wavecut scissors

Präparierscheren Dissecting Scissors



fein
delicate

PECK-JOSEPH



gerade
straight



gebogen
curved

Typ / Type	14,5 cm – 5¾"	
TC/W	MA 1666-64W	MA 1667-64W



JOSEPH



gerade
straight



gebogen
curved

Typ / Type	14 cm – 5½"	
	MA 1670-14	MA 1671-14
MC	MA 1670-14M	MA 1671-14M
TC	–	MA 1671-54
TC/MC	–	MA 1671-54M

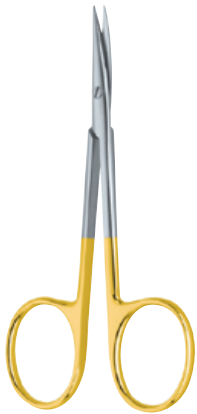

DEVINE

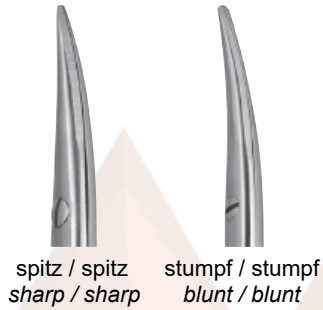

spitz / spitz stumpf / stumpf
sharp / sharp blunt / blunt

gebogen
curved

Typ / Type	11,5 cm – 4½"	
TC	MA 1673-07	MA 1673-08



KILNER



gebogen
curved

Typ / Type	12,5 cm – 5"	13,5 cm – 5¼"	15,5 cm – 6"
	MA 1675-12	MA 1675-13	MA 1675-15
MC	MA 1675-12M	–	–
CC	MA 1675-12C	–	–
TC	MA 1675-52	–	–

MC = SuperCut-Schere / SuperCut scissors TC
= Hartmetallschere / hard metal scissors

CC = Keramikbeschichtete Schere / Ceramic coated scissors W
= Wellenschliff-Schere / Wavecut scissors

Präparierscheren Dissecting Scissors



RUDOLF



stumpf / stumpf
blunt / blunt

gerade
straight



stumpf / stumpf
blunt / blunt

gebogen
curved

Typ / Type	11 cm – 4½"	
MC	MA 1676-01M	MA 1676-11M
MC/CC	–	MA 1676-11N
TC	–	MA 1676-51
TC/MC	–	MA 1676-51M
TC/W	–	MA 1676-51W



RUDOLF



stumpf / stumpf
blunt / blunt

gebogen
curved

Typ / Type	14,5 cm – 5¾"
MC	MA 1676-14M
MC/CC	MA 1676-14N
TC	MA 1676-54
TC/MC	MA 1676-54M
TC/W	MA 1676-54W



REYNOLDS



gebogen
curved

Typ / Type	13 cm – 5"
MC	MA 1677-13M

Präparierscheren Dissecting Scissors



FREEMAN-KAYE



gerade
straight



gebogen
curved

Typ / Type	18 cm – 7"	
MC	MA 1680-18M	MA 1681-18M
MC/CC	MA 1680-18N	MA 1681-18N

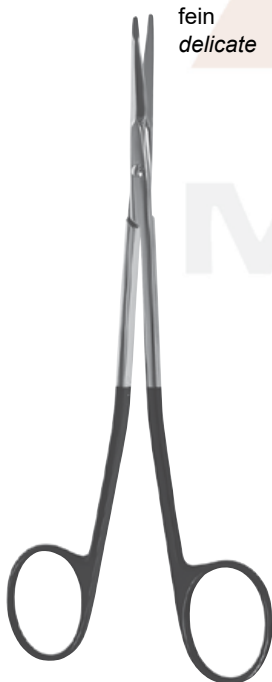

FREEMAN-KAYE

fein
delicate



gerade
straight



gebogen
curved

Typ / Type	18 cm – 7"	
MC	MA 1680-28M	MA 1681-28M
TC/MC	–	MA 1681-78M
TC/MC/CC	MA 1680-78N	MA 1681-78N
TC/W	–	MA 1681-78W

MC = SuperCut-Schere / SuperCut scissors TC
= Hartmetallschere / hard metal scissors

CC = Keramikbeschichtete Schere / Ceramic coated scissors W
= Wellenschliff-Schere / Wavecut scissors

Präparierscheren Dissecting Scissors



Typ / Type	18 cm – 7"
TC	MA 1681-78



Typ / Type	19 cm – 7½"	
MC	MA 1682-19M	MA 1683-19M
MC/CC	MA 1682-19N	MA 1683-19N
TC/MC	MA 1682-59M	MA 1683-59M

Präparierscheren Dissecting Scissors



KAYE



gebogen
curved

Typ / Type	15 cm – 6"	19 cm – 7½"
MC	MA 1685-15M	MA 1685-19M
MC/CC	MA 1685-15N	–
TC/MC	MA 1685-55M	MA 1685-59M
TC/MC/CC	MA 1685-55N	–
TC/W	MA 1685-55W	MA 1685-59W
gezahntsaw edge	MA 1685-15	–



KAYE-FACELIFT

fein
delicate



gebogen
curved

Typ / Type	15 cm – 6"	18 cm – 7"
TC/MC/CC	MA 1679-54N	MA 1679-58N
TC/W	MA 1679-54W	MA 1679-58W

MC = SuperCut-Schere / SuperCut scissors TC
= Hartmetallschere / hard metal scissors

CC = Keramikbeschichtete Schere / Ceramic coated scissors W
= Wellenschliff-Schere / Wavecut scissors

Präparierscheren Dissecting Scissors



CASTANARES



gerade
straight

Typ / Type	16 cm – 6¼"
MC	MA 1687-16M
TC/MC	MA 1687-56M
TC/W	MA 1687-56W



GORNEY



gerade
straight



gebogen
curved

Typ / Type	12 cm – 4¾"	
MC	MA 1688-12M	MA 1689-12M



MC = SuperCut-Schere / SuperCut scissors TC
= Hartmetallschere / hard metal scissors

CC = Keramikbeschichtete Schere / Ceramic coated scissors W
= Wellenschliff-Schere / Wavecut scissors

Präparierscheren Dissecting Scissors



GORNEY



gerade
straight



gebogen
curved

Typ / Type	18,5 cm – 7¼"	
MC	MA 1688-19M	MA 1689-19M
MC/CC	MA 1688-19N	MA 1689-19N
TC/MC	MA 1688-59M	MA 1689-59M



GORNEY

fein
delicate



gerade
straight



gebogen
curved

Typ / Type	19 cm – 7½"	
MC	MA 1688-29M	MA 1689-29M
TC	–	MA 1689-79
TC/MC	MA 1688-79M	MA 1689-79M
TC/MC/CC	MA 1688-79N	MA 1689-79N
TC/W	MA 1688-79W	MA 1689-79W

MC = SuperCut-Schere / SuperCut scissors TC
= Hartmetallschere / hard metal scissors

CC = Keramikbeschichtete Schere / Ceramic coated scissors W
= Wellenschliff-Schere / Wavecut scissors

Präparierscheren Dissecting Scissors



GORNEY



gerade
straight

gebogen
curved

Typ / Type	23 cm – 9"	
MC	MA 1690-23M	MA 1691-23M
TC/MC	MA 1690-53M	MA 1691-53M
TC/W	MA 1690-53W	MA 1691-53W



FREEMAN



gerade
straight

Typ / Type	18 cm – 7"	
MC	MA 1693-18M	
TC/MC	MA 1693-58M	
TC/W	MA 1693-58W	

Präparierscheren Dissecting Scissors

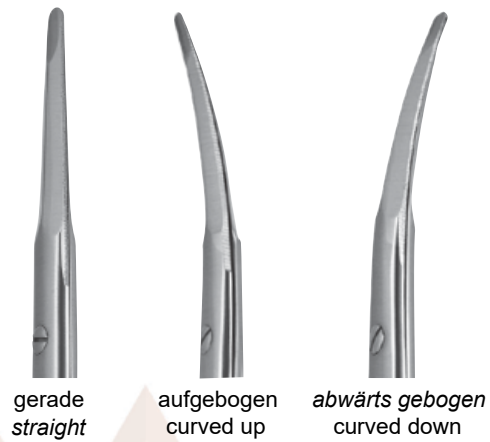
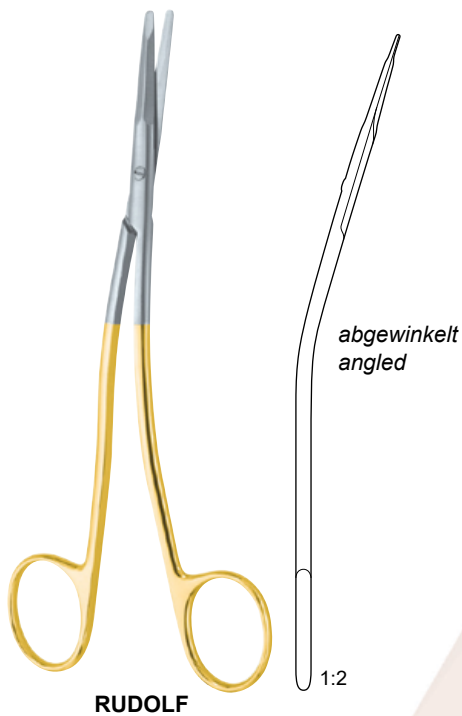

Typ / Type	18 cm – 7"	18 cm – 7"	18 cm – 7"
TC/MC	MA 1695-00M	MA 1695-01M	MA 1695-10M
TC/MC/CC	MA 1695-00N	MA 1695-01N	MA 1695-10N



Typ / Type	23 cm – 9"	23 cm – 9"	23 cm – 9"
TC/MC	MA 1695-02M	MA 1695-03M	MA 1695-11M
TC/MC/CC	MA 1695-02N	MA 1695-03N	MA 1695-11N

MC = SuperCut-Schere / SuperCut scissors
TC = Hartmetallschere / hard metal scissors

CC = Keramikbeschichtete Schere / Ceramic coated scissors
W = Wellenschliff-Schere / Wavecut scissors

Nasenscheren Nasal Scissors



HEYMANN

seitlich gewinkelt
angled to side

Typ / Type	18 cm – 7"
	MA 2115-18
MC	MA 2115-18M
TC	MA 2115-58



HEYMANN

seitlich gewinkelt
angled to side

19,5 cm – 7¾"

MA 2116-19



gezahnt
serrated edge

seitlich gewinkelt
angled to side

19 cm – 7½"

MA 2117-18



MC = SuperCut-Schere / SuperCut scissors
TC = Hartmetallschere / hard metal scissors

CC = Keramikbeschichtete Schere / Ceramic coated scissors
W = Wellenschliff-Schere / Wavecut scissors

Nasenscheren Nasal Scissors



COTTLE-MASING

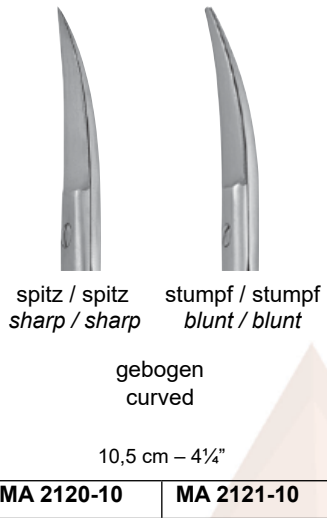

spitz / spitz stumpf / stumpf
sharp / sharp blunt / blunt

gebogen
curved

10,5 cm – 4¼"

MA 2120-10	MA 2121-10
-------------------	-------------------



KILNER



gerade
straight

11,5 cm – 4½"

MA 2124-11

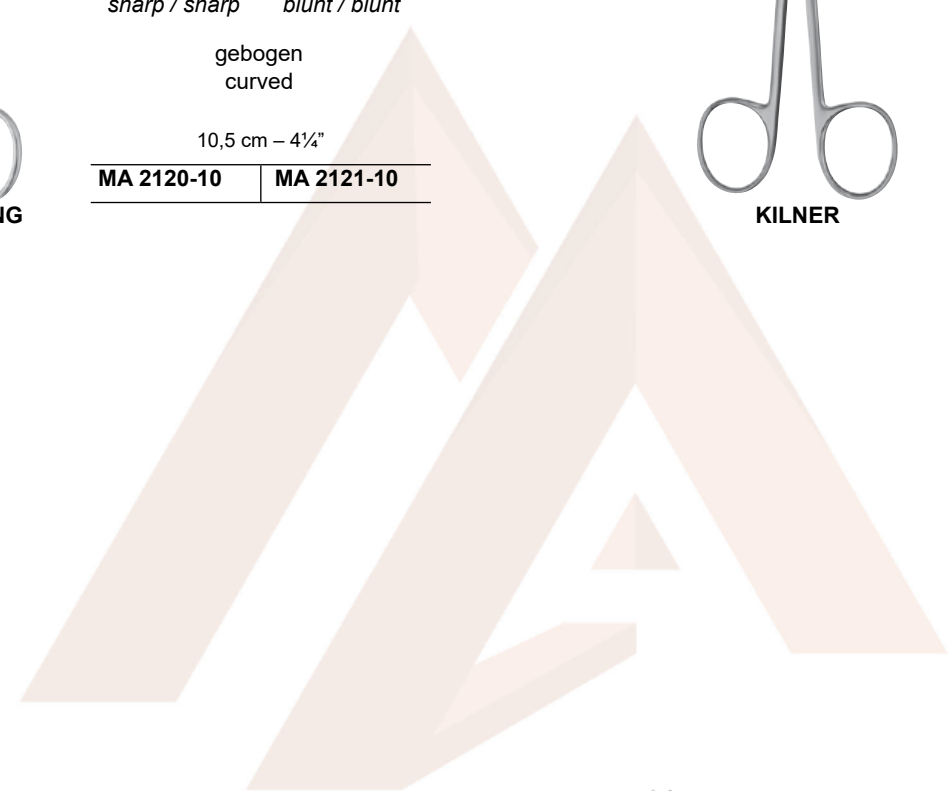

FOMON-SABER-BACK



gebogen
curved

Typ / Type	13 cm – 5"
MC	MA 2125-13M
TC/MC/CC	MA 2125-53N



FOMON

abgewinkelt
angled down

Typ / Type	13 cm – 5"
TC	MA 2129-13
TC/MC	MA 2129-13M
TC/W	MA 2129-13W

MC = SuperCut-Schere / SuperCut scissors
TC = Hartmetallschere / hard metal scissors

CC = Keramikbeschichtete Schere / Ceramic coated scissors
W = Wellenschliff-Schere / Wavecut scissors

Nasenscheren Nasal Scissors



abgewinkelt
angled down

FOMON

Typ / Type	13 cm – 5"
	MA 2130-13
MC	MA 2130-13M



schlankes Modell
slender pattern

abgewinkelt
angled down

FOMON

Typ / Type	13,5 cm – 5¼"
	MA 2131-13
MC	MA 2131-13M



FOMON

Typ / Type	13,5 cm – 5¼"
	MA 2132-13
MC	MA 2132-13M



gebogen
curved



abgewinkelt
angled down

COTTLE

Typ / Type	16 cm – 6¼"
	MA 2135-16
MC	MA 2135-16M

Nasenscheren Nasal Scissors



abgewinkelt
angled down

COTTLE

Typ / Type	16 cm – 6¼"
TC	MA 2136-16
TC/MC	MA 2136-16M
TC/W	MA 2136-16W

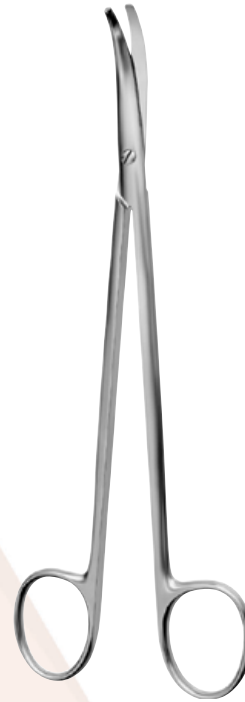

gebogen
curved

19 cm – 7½"

MA 2140-19

HALLE

M.ASHRAF
INSTRUMENTS

MC = SuperCut-Schere / *SuperCut scissors* TC
= Hartmetallschere / *hard metal scissors*

CC = Keramikbeschichtete Schere / *Ceramic coated scissors* W
= Wellenschliff-Schere / *Wavecut scissors*

Gefäßscheren Vascular Scissors

Gefäßschere
mit Knopf
Vascular scissors
probe-pointed

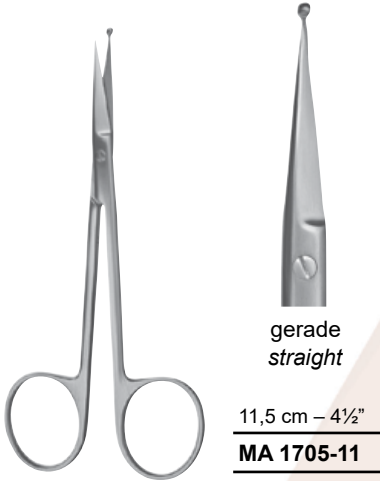

Speichelgangschere
mit Knopf
Salivary duct scissors
probe-pointed



spitz / spitz
sharp / sharp



spitz / stumpf
sharp / blunt

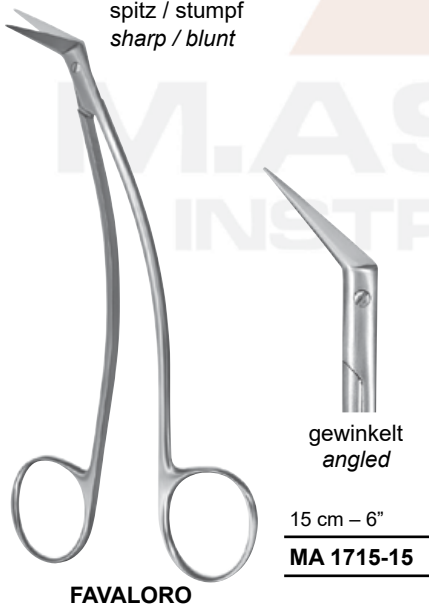

stumpf / stumpf
blunt / blunt

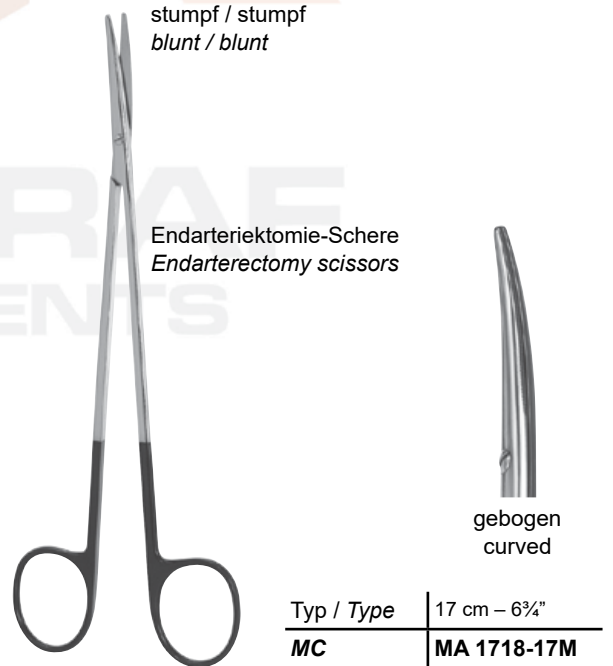

MC = SuperCut-Schere / SuperCut scissors TC
= Hartmetallschere / hard metal scissors

CC = Keramikbeschichtete Schere / Ceramic coated scissors W
= Wellenschliff-Schere / Wavecut scissors

Gefäßscheren Vascular Scissors



MARTIN-CARTILAGE

1:3



gebogen, gezahnt
curved, serrated edge

20 cm – 8"

MA 1725-19

Knorpelschere
Cartilage scissors
stumpf / stumpf
blunt / blunt

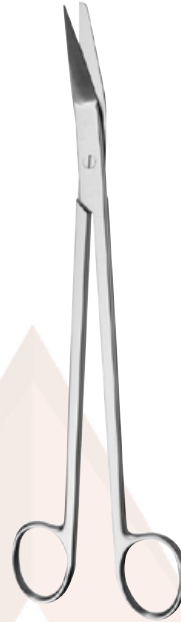

RESANO

1:3



gewinkelt
angled

25 cm – 10"

MA 1726-25

Kapselschere *Cap-
sule scissors*



MC INDOE

1:3



gerade
straight

19 cm – 7½"

MA 1730-19

M. ASHRAF
INSTRUMENTS

MC = SuperCut-Schere / *SuperCut scissors* TC
= Hartmetallschere / *hard metal scissors*

CC = Keramikbeschichtete Schere / *Ceramic coated scissors* W
= Wellenschliff-Schere / *Wavecut scissors*

Gefäßscheren Vascular Scissors

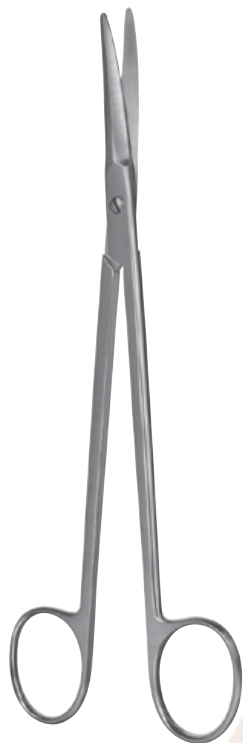

POTTS-SMITH



gebogen
curved

19 cm – 7½"

MA 1735-19



JORGENSEN



gebogen
curved

Typ / Type	22 cm – 8¾"
	MA 1739-22
MC	MA 1739-22M

M.ASHRAF
INSTRUMENTS



MC = SuperCut-Schere / *SuperCut scissors* TC
= Hartmetallschere / *hard metal scissors*

CC = Keramikbeschichtete Schere / *Ceramic coated scissors* W
= Wellenschliff-Schere / *Wavecut scissors*

Gefäßscheren Vascular Scissors

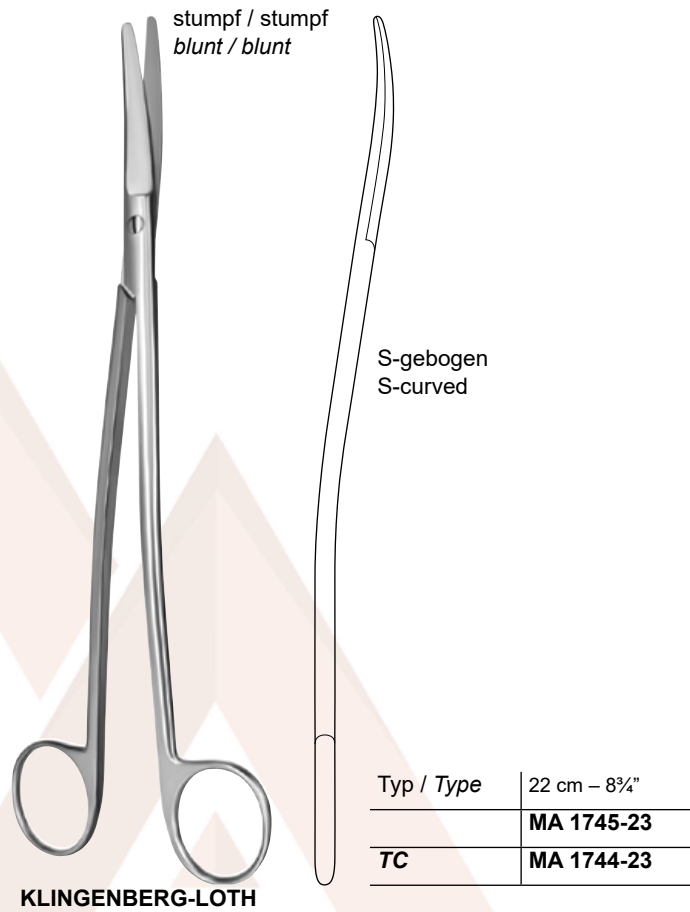
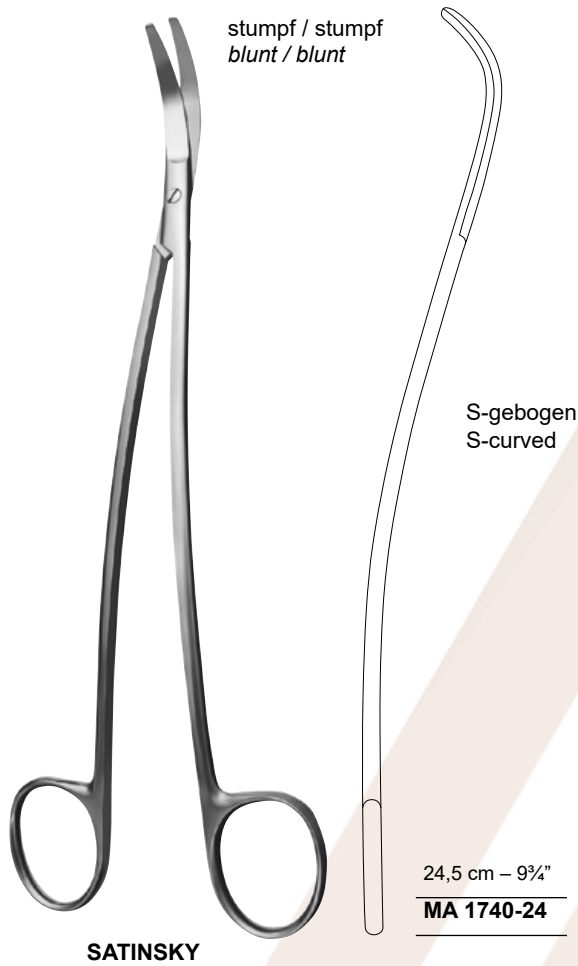

M.ASHRAF
INSTRUMENTS

MC = SuperCut-Schere / *SuperCut scissors* TC
= Hartmetallschere / *hard metal scissors*

CC = Keramikbeschichtete Schere / *Ceramic coated scissors* W
= Wellenschliff-Schere / *Wavecut scissors*

Gefäßscheren Vascular Scissors



POTTS-SMITH

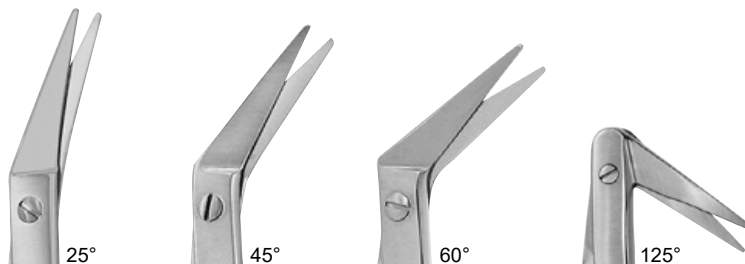

Typ / Type	gewinkelt angled			
	18,5 cm – 7¼"		18 cm – 7"	
	MA 1720-19	MA 1721-19	MA 1722-19	MA 1723-19
MC	MA 1720-19M	MA 1721-19M	MA 1722-19M	–
CC	MA 1720-19C	MA 1721-19C	MA 1722-19C	–
MC/CC	MA 1720-19N	MA 1721-19N	MA 1722-19N	–
TC	MA 1724-25	MA 1724-45	MA 1724-60	–



DE BAKEY

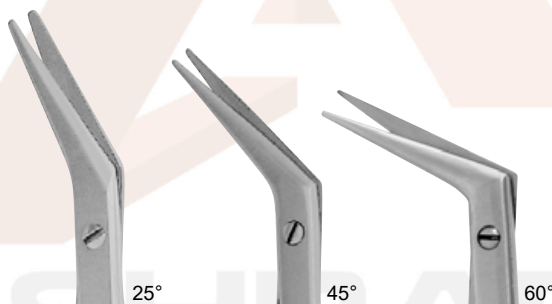

Typ / Type	gewinkelt angled		
	17 cm – 6¾"	16,5 cm – 6½"	16 cm – 6¼"
	MA 1750-16	MA 1752-16	MA 1754-16
TC	MA 1755-25	MA 1755-45	MA 1755-60
	MA 1750-23	MA 1752-23	MA 1754-23
TC	MA 1756-25	MA 1756-45	MA 1756-60
	MA 1750-28	–	MA 1754-28

Gefäßscheren Vascular Scissors



HEGEMANN-DIETRICH



gewinkelt *angled*

	13,5 cm – 5¼"		13 cm – 5"	13,5 cm – 5¼"	–
Typ / Type	MA 1760-13	MA 1761-13	MA 1762-13	MA 1763-13	–
	15,5 cm – 6"		14,5 cm – 5¾"	14 cm – 5½"	
	MA 1760-16	MA 1761-16	MA 1762-16	MA 1763-16	MA 1764-16
	18 cm – 7"		17,5 cm – 7"	17 cm – 6¾"	
	MA 1760-19	MA 1761-19	MA 1762-19	MA 1763-19	MA 1764-19
MC	MA 1760-19M	MA 1761-19M	MA 1762-19M	MA 1763-19M	MA 1764-19M
MC/CC	–	MA 1761-19N	–	–	–



HEGEMANN-DIETRICH

mit Führungsschiene
with stabilising bar



125°

gewinkelt
angled

Typ / Type	17 cm – 6¾"
	MA 1765-19
MC	MA 1765-19M

MC = SuperCut-Schere / *SuperCut scissors* TC
= Hartmetallschere / *hard metal scissors*

CC = Keramikbeschichtete Schere / *Ceramic coated scissors* W
= Wellenschliff-Schere / *Wavecut scissors*

Gefäßscheren Vascular Scissors

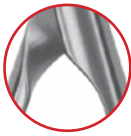

STREAMLINE

durch den geschwungenen Schluss verfängt sich der Faden nicht mehr, sondern gleitet über die Oberfläche.

weniger Reparatur anfällig

because of the curved lock design the suture does not get caught and slides over the surface.

less prone to repairs



25°



45°



60°



90°



125°

Schneide mit Knopf, spitz, gewinkelt
Blade with button, sharp, angled

Typ / Type	17,5 cm – 7"		17 cm – 6¾"	16,5 cm – 6½"	
	MA 1770-25	MA 1770-45	MA 1770-60	MA 1770-90	MA 1770-99

Typ / Type	18 cm – 7"				
 TI	MA 1770-25V	MA 1770-45V	MA 1770-60V	MA 1770-90V	MA 1770-99V
	MA 1770-25R	MA 1770-45R	MA 1770-60R	MA 1770-90R	MA 1770-99R



25°



45°



60°



90°



125°

Schneide ohne Knopf, spitz, gewinkelt
Blade without button, sharp, angled

Typ / Type	17,5 cm – 7"		17 cm – 6¾"	16,5 cm – 6½"	
	MA 1771-25	MA 1771-45	MA 1771-60	MA 1771-90	MA 1771-99
TI	MA 1771-25T	MA 1771-45T	MA 1771-60T	MA 1771-90T	MA 1771-99T

Typ / Type	18 cm – 7"				
 TI	MA 1771-25V	MA 1771-45V	MA 1771-60V	MA 1771-90V	MA 1771-99V
	MA 1771-25R	MA 1771-45R	MA 1771-60R	MA 1771-90R	MA 1771-99R

Gefäßscheren Vascular Scissors

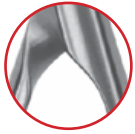

STREAMLINE

durch den geschwungenen Schluss verfängt sich der Faden nicht mehr, sondern gleitet über die Oberfläche.

weniger Reparatur anfällig

because of the curved lock design the suture does not get caught and slides over the surface.

less prone to repairs

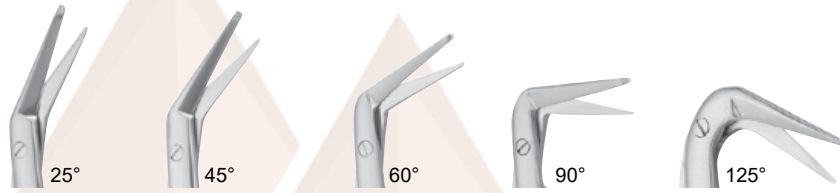

Schneide mit Knopf, spitz, gewinkelt
Blade with button, sharp, angled

17,5 cm – 7"		17 cm – 6¾"		16,5 cm – 6½"	
MA 1772-25	MA 1772-45	MA 1772-60	MA 1772-90	MA 1772-99	

	MA 1772-25R	MA 1772-45R	MA 1772-60R	MA 1772-90R	MA 1772-99R
STREAMLINE					

M.ASHRAF INSTRUMENTS



Schneide ohne Knopf, spitz, gewinkelt
Blade without button, sharp, angled

17,5 cm – 7"		17 cm – 6¾"		16,5 cm – 6½"	
MA 1773-25	MA 1773-45	MA 1773-60	MA 1773-90	MA 1773-99	

	MA 1773-25R	MA 1773-45R	MA 1773-60R	MA 1773-90R	MA 1773-99R
STREAMLINE					



Neurochirurgische Scheren Neurosurgical Scissors



POTTS-DE MARTEL

45° gewinkelt
45° angled

21 cm – 8¼"

MA 2490-21



MILLS

45° gewinkelt,
geknöpft 45°
angled, probe
pointed

21 cm – 8¼"

MA 2491-21



SCHMIEDEN-TAYLOR

Duraschere
Dura scissors

60° gewinkelt,
geknöpft 60°
angled, probe
pointed

14,5 cm – 5¾"

MA 2495-14



SCHMIEDEN-TAYLOR

Duraschere,
kräftiges Modell
Dura scissors,
strong pattern

60° gewinkelt,
geknöpft
60° angled, probe
pointed

17 cm – 6¾"

MA 2495-17

Neurochirurgische Scheren Neurosurgical Scissors



STRULLY



spitz, gebogen
sharp, curved



geknöpft, gebogen
probe pointed, curved

22 cm – 8¾"

MA 2496-22

MA 2497-22



Nerv-Präparierschere
Nerve dissecting scissors



gebogen
curved

15,5 cm – 6"

MA 1792-15

M.ASHRAF
INSTRUMENTS

Tonsillen-Scheren Tonsil Scissors

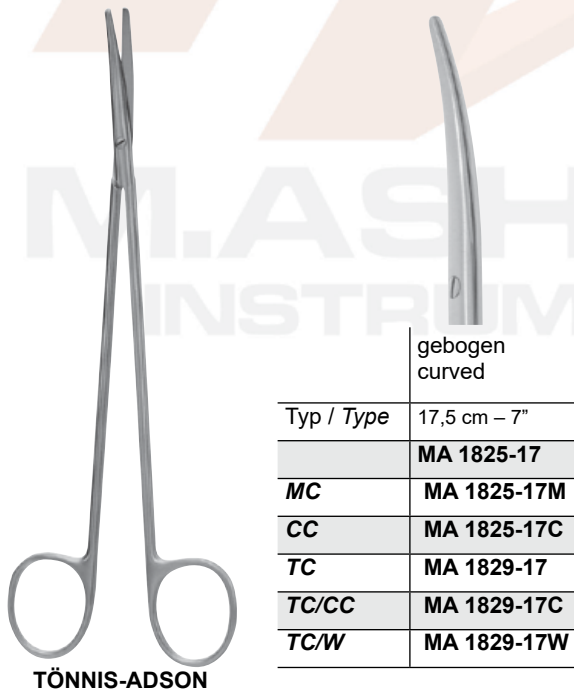
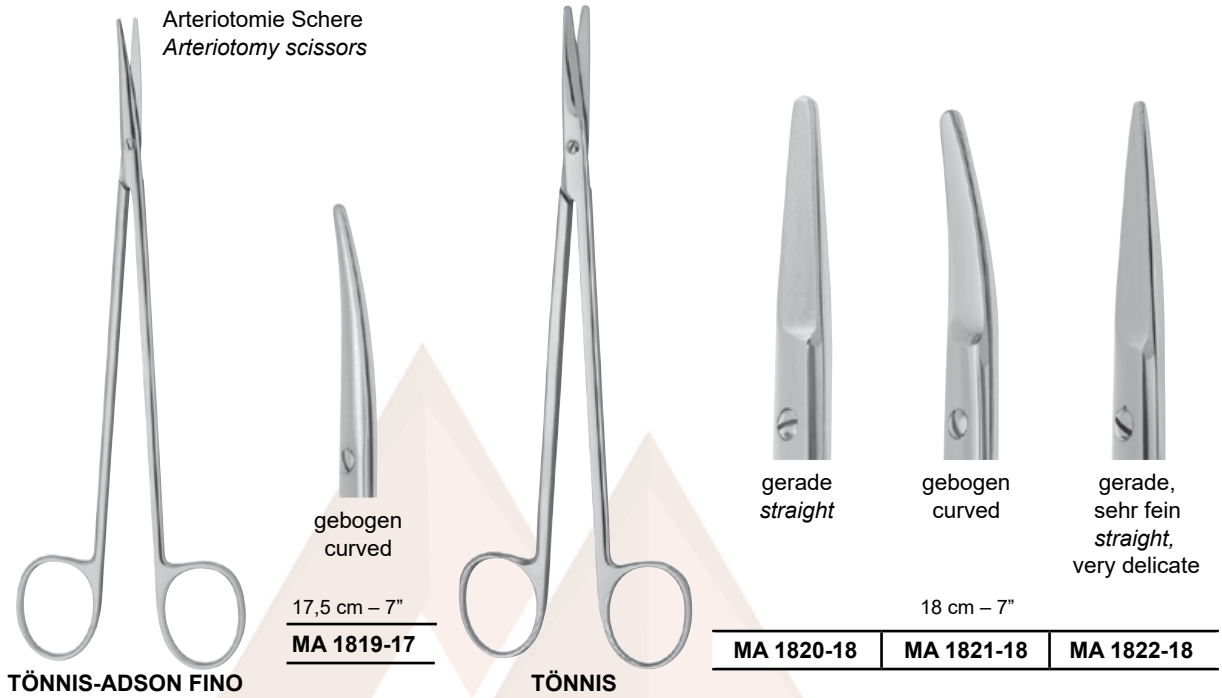

Tonsillen-Scheren Tonsil Scissors



MC = SuperCut-Schere / SuperCut scissors TC
= Hartmetallschere / hard metal scissors

CC = Keramikbeschichtete Schere / Ceramic coated scissors W
= Wellenschliff-Schere / Wavecut scissors

Darmscheren
Enterotomy Scissors



M.ASHRAF
INSTRUMENTS

Ligaturscheren Ligature Scissors



SPENCER

	gerade- straight
9 cm – 3½"	MA 2510-09
10,5 cm – 4¼"	MA 2510-10
12 cm – 4¾"	MA 2510-12



SPENCER-FINO

	gerade- straight
11 cm – 4¼"	MA 2512-11
16 cm – 6¼"	MA 2514-16



LITTAUER

	gerade straight
14 cm – 5½"	MA 2500-14



SHORTBENT

	gebogen curved
9 cm – 3½"	MA 2520-09



NORTHBENT

	gebogen curved
12,5 cm – 5"	MA 2520-12



	gewinkelt angled
Typ / Type	12,5 cm – 5"
	MA 2522-11
CC	MA 2522-11C

MC = SuperCut-Schere / SuperCut scissors TC
= Hartmetallschere / hard metal scissors

CC = Keramikbeschichtete Schere / Ceramic coated scissors W
= Wellenschliff-Schere / Wavecut scissors

Ligaturscheren Ligature Scissors

Speziell zum Schneiden von Nahtmaterial:

Schneiden mit aufgeschweißtem Hartmetall für erhöhte Standzeit

fein gezahntes Blatt verhindert ein Herausrutschen des Nahtmaterials

weit auslaufender Schluss verhindert ein Einklemmen oder Verfangen des Nahtmaterials weit herausgestellte Griffbranchen für optimierte Handhabung

Especially for the cutting of suture material:

blades with welded hard metal for extended lifetime fine serrated blade prevents the slipping of suture material

smoothly widening lock design prevents the suture material from getting caught in the parts of scissors exposed handles for optimized handling



gebogen
curved

Typ / Type	14,5 cm – 5¾"	18 cm – 7"	23 cm – 9"	26 cm – 10¼"
TC	MA 1314-14RS	MA 1334-18RS	MA 1334-23RS	MA 1334-26RS



gerade
straight

10 cm – 4"
MA 2535-10



SCHOEMAKER-LOTH



12,5 cm – 5"
MA 2548-12



Präparierschere mit
Fadenbohrung
*Dissecting scissors
with suture holes*



gebogen
curved

11,5 cm – 4½"
MA 2526-11

LITTLER

Gynäkologische Scheren Gynecological Scissors



SIMS



stumpf / stumpf
blunt / blunt

spitz / stumpf
sharp / blunt

	Typ Type	gerade- straight	gebogen- curved	gerade- straight	gebogen- curved
20 cm – 8"		MA 1401-20	MA 1411-20	MA 1402-20	MA 1412-20
	MC	MA 1401-20M	MA 1411-20M	–	–
23 cm – 9"		MA 1401-23	MA 1411-23	MA 1402-23	MA 1412-23
	MC	–	MA 1411-23M	–	–



SIMS



stumpf / stumpf
blunt / blunt

	Typ Type	gebogen- curved
20 cm – 8"	MC	MA 1414-20M
	TC	MA 1414-20
23 cm – 9"	MC	MA 1414-23M
	TC	MA 1414-23

MC = SuperCut-Schere / SuperCut scissors
TC = Hartmetallschere / hard metal scissors

CC = Keramikbeschichtete Schere / Ceramic coated scissors
W = Wellenschliff-Schere / Wavecut scissors

Gynäkologische Scheren Gynecological Scissors

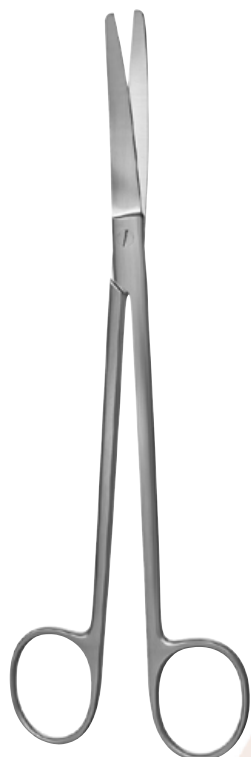

WERTHEIM



	gebogen- curved
14,5 cm – 5¾"	MA 1415-14
19,5 cm – 7¾"	MA 1415-19
22,5 cm – 8¾"	MA 1415-22



DUBOIS

1:3

Kephalotomie-Schere
Cephalotomy scissors



gerade
straight



gebogen
curved

27 cm – 10½"

MA 1420-27	MA 1421-27
-------------------	-------------------

Gynäkologische Scheren Gynecological Scissors



DOYEN



spitz / stumpf
sharp / blunt

stumpf / stumpf
blunt / blunt

gerade
straight

gerade
straight

gebogen
curved

16 cm – 6¼"	MA 1428-16	MA 1430-16	MA 1431-16
18 cm – 7"	–	MA 1430-18	MA 1431-18

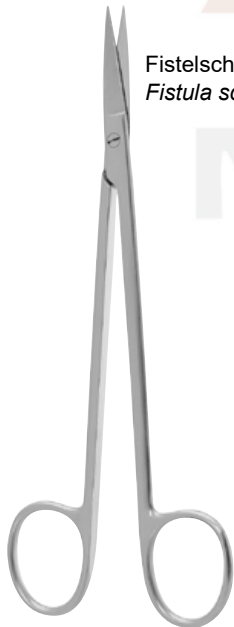

KELLY

Fistelschere
Fistula scissors



gerade
straight

gebogen
curved

gerade
straight

gebogen
curved

Typ / Type	16 cm – 6¼"		18 cm – 7"	
	MA 1440-16	MA 1441-16	MA 1440-18	MA 1441-18
MC	MA 1440-16M	MA 1441-16M	–	–
CC	–	MA 1441-16C	–	–
TC	MA 1444-16	MA 1445-16	–	–
TC/MC	MA 1444-16M	MA 1445-16M	–	–

MC = SuperCut-Schere / SuperCut scissors
TC = Hartmetallschere / hard metal scissors

CC = Keramikbeschichtete Schere / Ceramic coated scissors W
= Wellenschliff-Schere / Wavecut scissors

Gynäkologische Scheren Gynecological Scissors



SIEBOLD

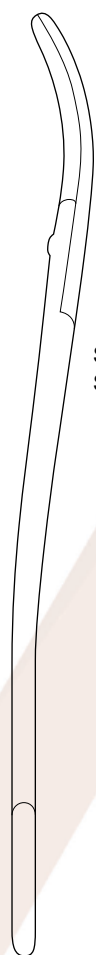

Uterusschere
Uterine scissors

S-gebogen
S-curved



Typ / Type	24 cm – 9½"
	MA 1455-24
MC	MA 1455-24M

M.ASHRAF
INSTRUMENTS



MC = S uperCut-Schere / *SuperCut scissors*
TC = Hartmetallschere / *hard metal scissors*

CC = Keramikbeschichtete Schere / *Ceramic coated scissors* W
= Wellenschliff-Schere / *Wavecut scissors*

Nabelschnurscheren
Umbilical Scissors



BUSCH



gebogen
curved

16 cm – 6¼"

MA 2000-16



SCHUMACHER

16 cm – 6¼"

MA 2010-16



**MODELL USA
USA PATTERN**

10,5 cm – 4¼"

MA 2020-10

M.ASHRAF
INSTRUMENTS

Damm-(Episiotomie-)Scheren Perineum (Episiotomy) Scissors



BRAUN-STADLER

Typ / Type	14 cm – 5½"	22 cm – 8¾"
	MA 2050-14	MA 2055-22
MC	MA 2050-14M	MA 2055-22M



seitwärts gewinkelt
angled to side



WALDMANN



gezahntser-
rated

Typ / Type	18 cm – 7"
	MA 2085-18
MC	MA 2085-18M
CC	MA 2085-18C
MC/CC	MA 2085-18N



gezahnt
serrated

Typ / Type	19 cm – 7½"
	MA 2086-19
MC	MA 2086-19M



gezahnt
serrated

Typ / Type	19 cm – 7½"
TC	MA 2087-19
TC/MC	MA 2087-19M
TC/CC	MA 2087-19C



MC = SuperCut-Schere / SuperCut scissors
TC = Hartmetallschere / hard metal scissors

CC = Keramikbeschichtete Schere / Ceramic coated scissors W
= Wellenschliff-Schere / Wavecut scissors

Parametriumscheren Parametrium Scissors



1:3



gebogen
curved

Fig. 1

Fig. 2

Fig. 3

Fig. 4

TC	23 cm – 9"	MA 2090-11	MA 2090-12	MA 2090-13	MA 2090-14
TC	26,5 cm – 10½"	MA 2090-21	MA 2090-22	MA 2090-23	MA 2090-24
TC	30 cm – 11¾"	MA 2090-31	MA 2090-32	MA 2090-33	MA 2090-34



1:3



gebogen
curved

MC	27,5 cm – 10¾"	MA 2091-01M	MA 2091-02M	MA 2091-03M
-----------	----------------	--------------------	--------------------	--------------------

MC = SuperCut-Schere / SuperCut scissors
TC = Hartmetallschere / hard metal scissors

CC = Keramikbeschichtete Schere / Ceramic coated scissors
W = Wellenschliff-Schere / Wavecut scissors

Kronenscheren Crown Scissors



BEEBEE



spitz / spitz
gerade

*sharp / sharp
straight*



spitz / spitz
gebogen

*sharp / sharp
curved*

10,5 cm – 4¼"

MA 2870-10

MA 2871-10



BEEBEE



stumpf / stumpf
gerade, gezahnt

*blunt / blunt
straight, serrated*



stumpf / stumpf
gebogen, gezahnt

*blunt / blunt
curved, serrated*

12 cm – 4¾"

MA 2890-12

MA 2891-12

Zahnfleischscheren Gum Scissors



DEAN



gewinkelt, gezahnt
angled, serrated

17 cm – 6¾"

MA 2913-17



LOCKLIN



gewinkelt, gezahnt
angled, serrated

16,5 cm – 6½"

MA 2918-16



SULLIVAN



gezahnt
serrated

gerade
straight

gebogen
curved

14,5 cm – 5¾"

MA 2920-14

MA 2921-14

MASHRAF
INSTRUMENTS



Zahnfleischscheren Gum Scissors

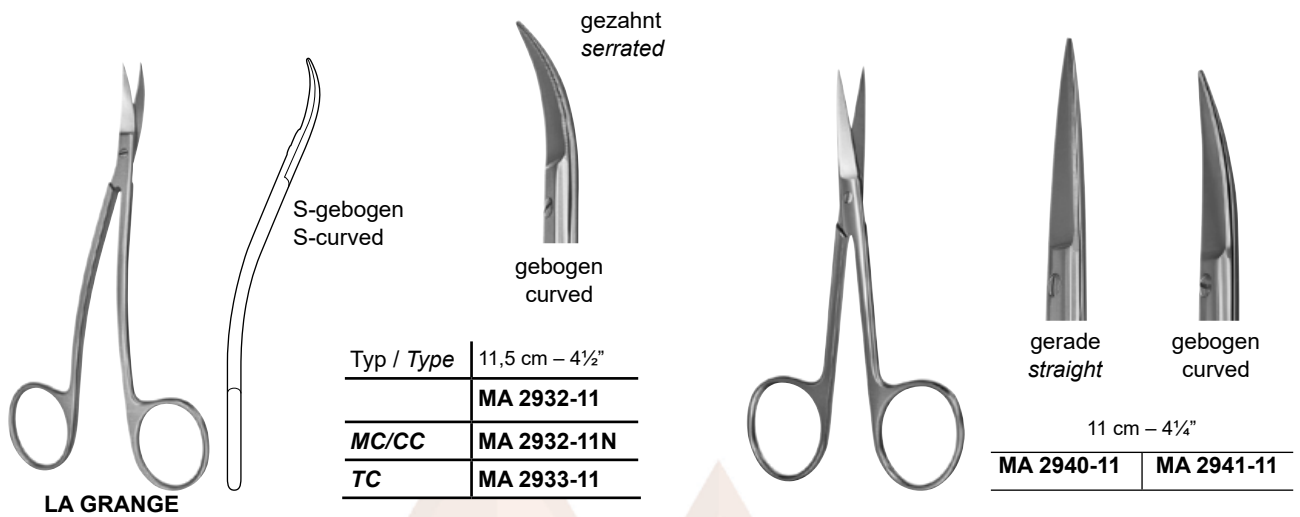

M.ASHRAF
INSTRUMENTS



MC = S uperCut-Schere / *SuperCut scissors* TC
= Hartmetallschere / *hard metal scissors*

CC = Keramikbeschichtete Schere / *Ceramic coated scissors* W
= Wellenschliff-Schere / *Wavecut scissors*

Nagelscheren Nail Scissors



10,5 cm – 4¼"

MA 2980-10	MA 2981-10
-------------------	-------------------



9 cm – 3½"

MA 2983-09
10,5 cm – 4¼"
MA 2983-10



Typ / Type	13 cm – 5"	15 cm – 6"
	MA 2620-13	MA 2620-15
W	–	MA 2620-15W

MC = SuperCut-Schere / SuperCut scissors
TC = Hartmetallschere / hard metal scissors

CC = Keramikbeschichtete Schere / Ceramic coated scissors W
= Wellenschliff-Schere / Wavecut scissors

Draht-, Blechscheren Wire, Metal Cutting Scissors



Drahtschere
Wire cutting scissors



seitwärts gewinkelt-
angled to side

Typ / Type	12,5 cm – 5"
	MA 2600-12
TC	MA 2601-12



Draht- und
Blechscherer
Wire and metal
cutting scissors



seitwärts gewinkelt-
angled to side

Typ / Type	16,5 cm – 6½"
TC	MA 2603-16



MC = SuperCut-Schere / *SuperCut scissors* TC
= Hartmetallschere / *hard metal scissors*

CC = Keramikbeschichtete Schere / *Ceramic coated scissors* W
= Wellenschliff-Schere / *Wavecut scissors*

Verbandscheren Bandage Scissors



	seitwärts gewinkeltan- gled to side
	14,5 cm – 5¾"
schwarz- black	MA 2602-14



	seitwärts gewinkeltan- gled to side
	16 cm – 6¼"
schwarz- black	MA 2602-16

RUDOLF



	seitwärts gewinkeltan- gled to side
	18 cm – 7"
schwarz- black	MA 2602-18

M.ASHRAF
INSTRUMENTS

Verbandscheren Bandage Scissors



SMITH



gezahnt
serrated

17,5 cm – 7"

MA 2608-17



HARVEY



stumpf / stumpf
gezahnt
blunt / blunt
serrated

12,5 cm – 5"

MA 2610-12



LISTER

	Typ Type	seitwärts gewinkeltan- gled to side
9 cm – 3½"		MA 2650-09
11 cm – 4¼"		MA 2650-11
14,5 cm – 5¾"		MA 2650-14
	MC	MA 2650-14M
15,5 cm – 6"		MA 2650-15
18 cm – 7"		MA 2650-18
	MC	MA 2650-18M
	TC	MA 2651-18
20 cm – 8"		MA 2650-20
	MC	MA 2650-20M

Verbandscheren Bandage Scissors



LISTER

	seitwärts gewinkelt <i>angled to side</i>
Typ / Type	21 cm – 8¼"
	MA 2652-21
MC	MA 2652-21M



LISTER-EXCENTRIC

obere Schneide gezahnt,
seitwärts gewinkelt
*upper blade serrated,
angled to side*

16 cm – 6¼"	MA 2654-16
19 cm – 7½"	MA 2654-19



ESMARCH

seitwärts gewinkelt
angled to side

Typ / Type	20 cm – 8"	22 cm – 8¾"
	MA 2655-20	MA 2655-22
TC	MA 2656-20	–

MC = SuperCut-Schere / *SuperCut scissors* TC
= Hartmetallschere / *hard metal scissors*

CC = Keramikbeschichtete Schere / *Ceramic coated scissors* W
= Wellenschliff-Schere / *Wavecut scissors*

M.ASHRAF
INSTRUMENTS

Verbandscheren
Bandage Scissors



BERGMANN

seitwärts gewinkelt
angled to side

23 cm – 9"

MA 2660-23



gebogen
curved

23 cm – 9"

MA 2665-23



seitwärts gewinkelt,
gezahnt
*angled to side,
saw edge*

17 cm – 6¾"

MA 2668-17

Verbandscheren Bandage Scissors



BRUNS



glatt
smooth



gezahnt
saw edge

24 cm – 9½"

MA 2690-24

MA 2692-24

M.ASHRAF
INSTRUMENTS

Verbandscheren Bandage Scissors

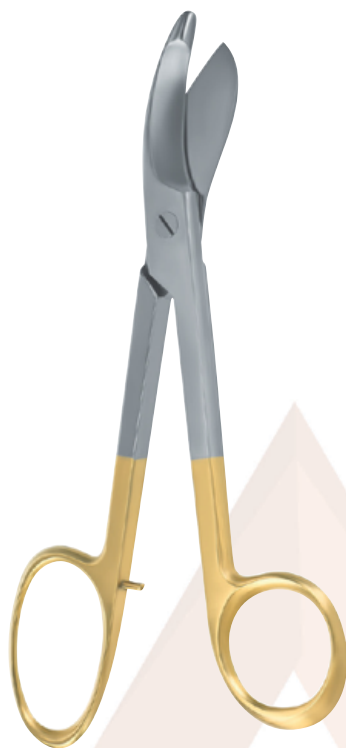

BABY-BRUNS



glatt
smooth

Typ / Type	19,5 cm – 7¾"
TC	MA 2693-20



BRUNS



glatt
smooth

Typ / Type	24 cm – 9½"
TC	MA 2693-24



MC = S uperCut-Schere / *SuperCut scissors* TC
= Hartmetallschere / *hard metal scissors*

CC = Keramikbeschichtete Schere / *Ceramic coated scissors* W
= Wellenschliff-Schere / *Wavecut scissors*

Verbandscheren Bandage Scissors



**SMITH
(MODELL USA)
(USA PATTERN)**

gerade
straight

18 cm – 7"

MA 2700-18



KNOWLES

geknöpft
probe pointed



gerade
straight

14 cm – 5½"

MA 2705-14



KNOWLES

geknöpft
probe pointed



seitwärts gewinkelt
angled to side

14 cm – 5½"

MA 2706-14

Gipsscheren Plaster Shears

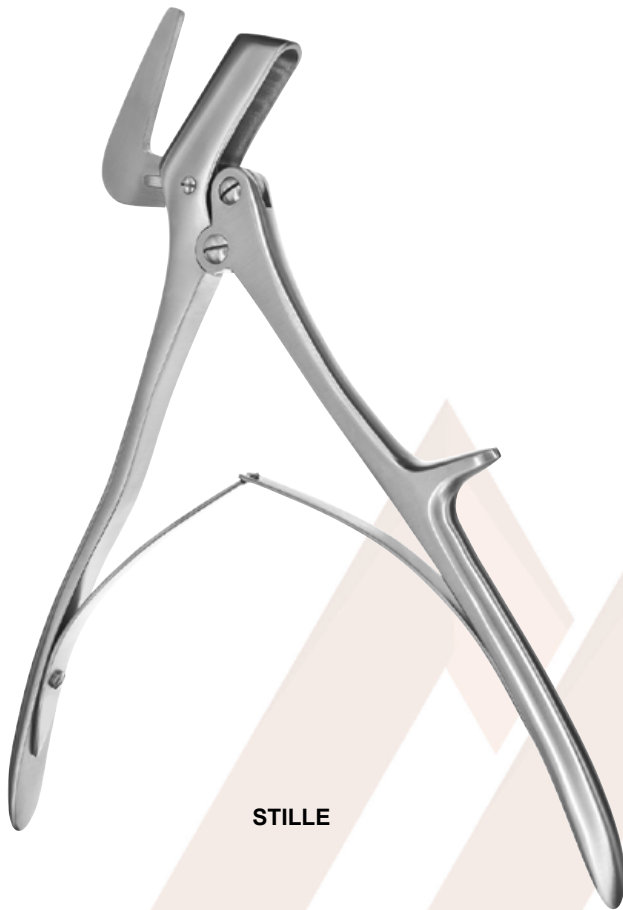

STILLE

24 cm – 9½"

MA 2835-24



STILLE

23 cm – 9" | **MA 2840-23**

26 cm – 10¼" | **MA 2840-26**

37 cm – 14½" | **MA 2840-37**

Knochenschere Bone Scissors



kniegebogen
gezahnt
curved to side
serrated

mit Bügel
with clamp

20 cm – 8"

MA 2710-20



kniegebogen
gezahnt
curved to side
serrated

23 cm – 9"

MA 2715-23

SEUTIN



gerade
straight

23 cm – 9"

MA 2800-23

M.ASHRAF
INSTRUMENTS



Rippenscheren
Rib Shears

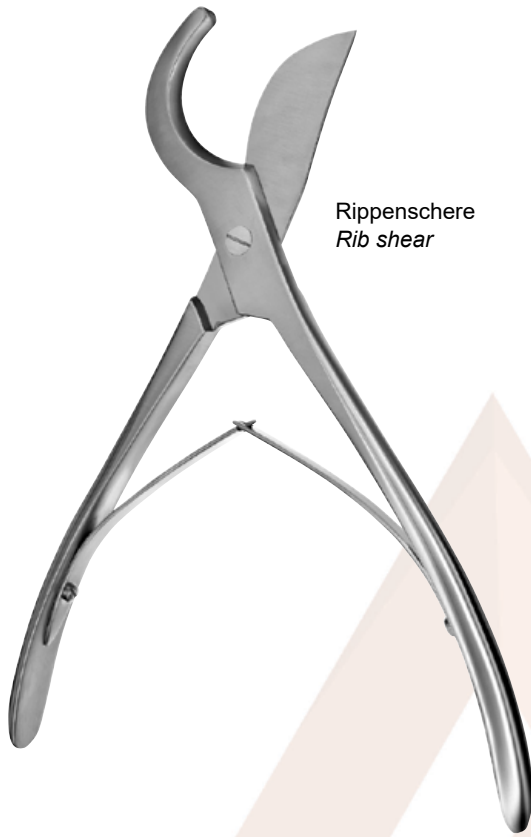

Rippenschere
Rib shear

COLLIN

22 cm – 8¾"
MA 2805-22



Rippenschere
Rib shear

GLUCK

22 cm – 8¾"
MA 2820-22

M.ASHRAF
INSTRUMENTS

TWO



M.ASHRAF
INSTRUMENTS

Skalpelle und Messer

Scalpels and Knives

Skalpelle	<i>Scalpels</i>	SK 1 - 4
Rasierklingen, Rasierklingenbrecher und -halter	<i>Razor Blades, Razor Blade Breaker and -Holder</i>	SK 5 - 6
Anatomische Skalpelle	<i>Dissecting Knives</i>	SK 7
Amputationsmesser	<i>Amputation Knives</i>	SK 8
Resektions- und Seziersmesser	<i>Resection- and Autopsy Knives</i>	SK 9
Dermatome	<i>Dermatomes</i>	SK 10

Mini-Klingen-System
Mini-Blade-System

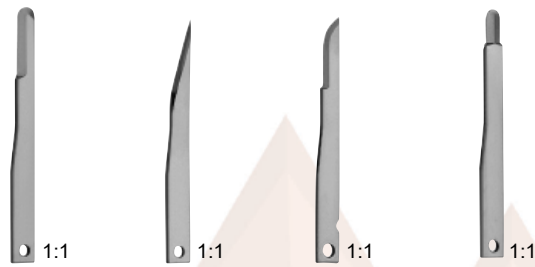

steril, Verpackungseinheit à 10 Klingen
sterile, Packing unit 10 blades

Fig. 64	Fig. 65	Fig. 67	Fig. 69
MA 4853-64	MA 4853-65	MA 4853-67	MA 4853-69



10 cm – 4"
MA 4853-33



13,5 cm – 5¼"
MA 4853-34



15,5 cm – 6"
MA 4853-35



CASPAR
18 cm – 7"
MA 4854-03



20 cm – 8"
MA 4854-04

Skalpelle Scalpels

Verpackungseinheit à 100 Klingen
Packing unit 100 blades

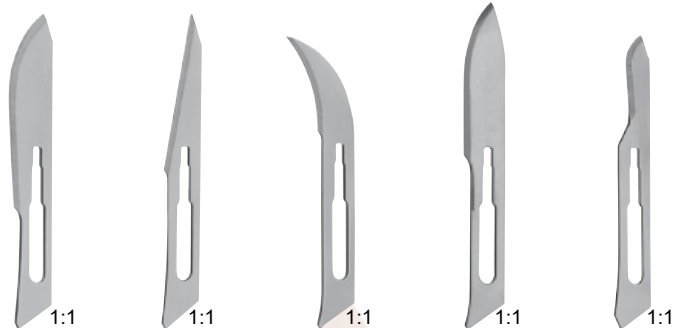

	Fig. 10	Fig. 11	Fig. 12	Fig. 13	Fig. 15
unsteril- non-sterile	MA 4851-10	MA 4851-11	MA 4851-12	MA 4851-13	MA 4851-15
sterilsterile	MA 4852-10	MA 4852-11	MA 4852-12	MA 4852-13	MA 4852-15



No. 3
12,5 cm – 5"
MA 4850-03



No. 3
12,5 cm – 5"
MA 4850-13



No. 7
16 cm – 6¼"
MA 4850-07



No. 7 K 12 cm
– 4¾"
MA 4850-17

Verpackungseinheit à 100 Klengen
Packing unit 100 blades

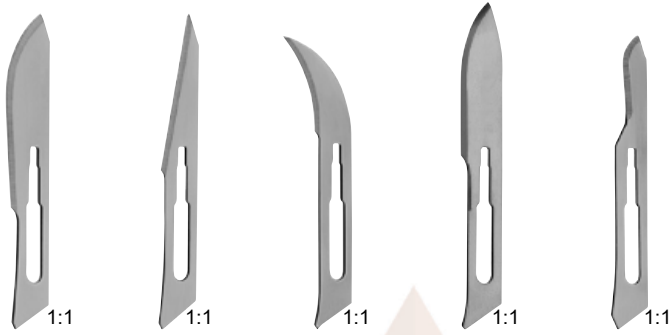

	Fig. 10	Fig. 11	Fig. 12	Fig. 13	Fig. 15
unsteril- non-sterile	MA 4851-10	MA 4851-11	MA 4851-12	MA 4851-13	MA 4851-15
sterilsterile	MA 4852-10	MA 4852-11	MA 4852-12	MA 4852-13	MA 4852-15



No. 3 L
21 cm – 8¼"
MA 4850-31



No. 3 LA 21
cm – 8¼"
MA 4850-32

abgewinkelt
angled



No. 5
15 cm – 6"
MA 4850-50



No. 5 A 15
cm – 6"
MA 4850-51

abgewinkelt
angled

Skalpelle Scalpels

Verpackungseinheit à 100 Klingen
Packing unit 100 blades



	Fig. 18	Fig. 19	Fig. 20	Fig. 21	Fig. 22	Fig. 23
unsteril- non-sterile	MA 4851-18	MA 4851-19	MA 4851-20	MA 4851-21	MA 4851-22	MA 4851-23
sterilsterile	MA 4852-18	MA 4852-19	MA 4852-20	MA 4852-21	MA 4852-22	MA 4852-23



No. 4
13,5 cm – 5¼"
MA 4850-04



No. 4
13,5 cm – 5¼"
MA 4850-14



No. 4 L
21 cm – 8¼"
MA 4850-41



No. 4 LA 21
cm – 8¼"
MA 4850-42

abgewinkelt
angeld

Rasierklingen, Rasierklingenbrecher und -halter Razor Blades, Razor Blade Breaker and Holder



MA 4874-00

Rasierklingen,
Verpackungseinheit à
10 Klingen

Razor Blades,
Packing unit
10 blades



Öffnen durch Zu-
rückschieben der
Hülse
*To open push
back the sleeve*



TROUTMAN-CHRIS

Griffdurchmesser
Handle diameter
Ø 5,5 mm



gerade
straight



gewinkelt
angled

9 cm – 3½"

MA 4876-09

MA 4877-09

M.ASHRAF INSTRUMENTS



CASTROVIEJO

Rasierklingenhalter
mit Riegelschloss
*Razor blade holder
with slide catch*

Griffdurchmesser
Handle diameter
Ø 8 mm



gerade
straight

12,5 cm – 5"

MA 4878-13



CASTROVIEJO

Schweizer Modell
Swiss pattern



gerade, glatt
straight, smooth

12 cm – 4¾"

MA 4878-33



Rasierklingen, Rasierklingenbrecher und -halter Razor Blades, Razor Blade Breaker and Holder



MA 4874-00

Rasierklingen,
Verpackungseinheit à
10 Klingen
*Razor Blades,
Packing unit
10 blades*



Öffnen durch Zu-
rückschieben der
Hülse
*To open push
back the sleeve*

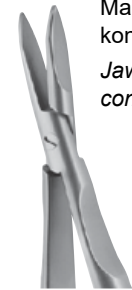

Maulinnenseite:
konkav/konvex
*Jaw inside:
concave/convex*

gerade
straight

13 cm – 5"

MA 4878-23



Rasierklingenbrecher
Razor blade breaker



gerade
straight

18,5 cm – 7¼"

MA 4879-18



Rasierklingenhalter
mit Sperre
*Razor blade holder
with ratchet*

BARRAQUER



gerade
straight

11 cm – 4¼"

MA 4878-53

Anatomische Skalpelle Dissecting Knives

mit Metallheft
with metal handle



Fig. 1	Fig. 2	Fig. 3	Fig. 4	Fig. 5
MA 4858-01	MA 4858-02	MA 4858-03	MA 4858-04	MA 4858-05

spitz
pointed



Fig. 6	Fig. 7	Fig. 8	Fig. 9	Fig. 10
MA 4858-06	MA 4858-07	MA 4858-08	MA 4858-09	MA 4858-10

Amputationsmesser Amputation Knives

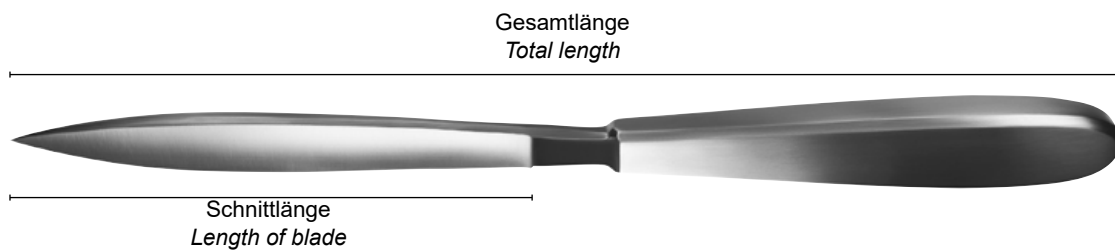

LISTON

Gesamtlänge Total length	Schnittlänge Length of blade	
26 cm – 10¼"	13 cm – 5"	MA 4880-13
29 cm – 11½"	16 cm – 6¼"	MA 4880-16
32 cm – 12½"	19 cm – 7½"	MA 4880-19
35 cm – 13¾"	22 cm – 8¾"	MA 4880-22



LISTON

Gesamtlänge Total length	Schnittlänge Length of blade	
31 cm – 12¼"	17 cm – 6¾"	MA 4881-17
34 cm – 13½"	20 cm – 8"	MA 4881-20

Resektions- und Seziermesser Resection- and Autopsy Knives

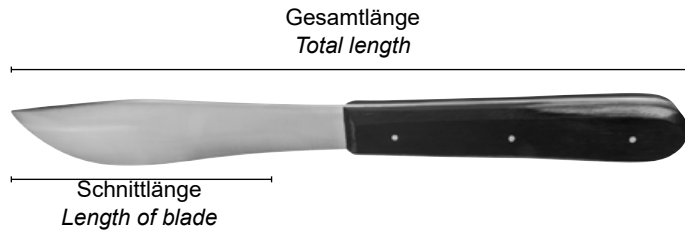

Resektionsmesser
Resection knife

Gesamtlänge Total length	Schnittlänge Length of blade	
18 cm – 7"	5,5 cm – 2¼"	MA 4888-05

LANGENBECK



Seziermesser
Autopsy knife

Gesamtlänge Total length	Schnittlänge Length of blade	
27 cm – 10½"	12 cm – 4¾"	MA 4892-11

1:3

M.ASHRAF
INSTRUMENTS



Seziermesser
Autopsy knife

Gesamtlänge Total length	Schnittlänge Length of blade	
23 cm – 9"	9 cm – 3½"	MA 4894-09

1:3
VIRCHOW

Dermatome Dermatomes



30 cm – 11¾"
MA 4899-00

SCHINK



Ersatzklinge, allein
Spare blade, only
MA 4899-01



19 cm – 7½"
MA 4899-03

SILVER

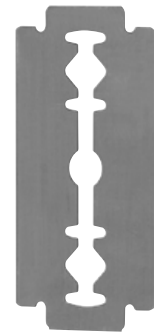

Ersatzklingen,
Verpackungseinheit à
10 Klingen

*Spare blades,
Packing unit 10
blades*

MA 4899-10

Dermatom **SCHINK**, einstellbar von 0,1 mm - 2,0 mm, komplett mit 1 x auswechselbarer Klinge MA 4899-01 und 2 Spannplatten MA 4899-02

*Dermatome **SCHINK**, adjustable from 0.1 mm - 2.0 mm, complete with 1 exchangeable blade MA 4899-01 and 2 straightening plates MA 4899-02*



Spannplatte allein für alle Dermatomen verwendbar
Skin straightening plate only usable for all dermatomes

MA 4899-02

THREE



M.ASHRAF
INSTRUMENTS

Pinzetten Forceps

Mikro-Uhrmacher Pinzetten	<i>Micro Jewelers Forceps</i>	FC 1
Mikro-Nahtpinzetten	<i>Micro Suture Forceps</i>	FC 2 - 3
Anatomische Mikro-Pinzetten	<i>Dissecting Micro Forceps</i>	FC 4 - 7
Mikro-Tumorfaßpinzetten	<i>Micro Tumor Grasping Forceps</i>	FC 8 - 9
Mikro-Pinzetten, Rundgriff	<i>Micro Forceps, Round Handle</i>	FC 10
Feine anatomische Pinzetten	<i>Delicate Dissecting Forceps</i>	FC 11 - 18
Anatomische Pinzetten	<i>Dissecting Forceps</i>	FC 19 - 21
Atraumatische Pinzetten	<i>Atraumatic Forceps</i>	FC 22
Ohrpinzetten	<i>Ear Dressing Forceps</i>	FC 23 - 24
Feine chirurgische Pinzetten	<i>Delicate Tissue Forceps</i>	FC 25 - 32
Chirurgische Pinzetten	<i>Tissue Forceps</i>	FC 33 - 36
Hautpinzetten	<i>Skin Forceps</i>	FC 37
Darm- und Lungenpinzetten	<i>Intestinal and Lung Forceps</i>	FC 38
Fasspinzetten	<i>Grasping Forceps</i>	FC 39
Splitterpinzetten	<i>Splinter Forceps</i>	FC 40
Splitterzangen	<i>Splinter Forceps</i>	FC 41
Cilienpinzetten	<i>Cilia Forceps</i>	FC 42

Mikro-Uhrmacher-Pinzetten Micro Jewelers Forceps

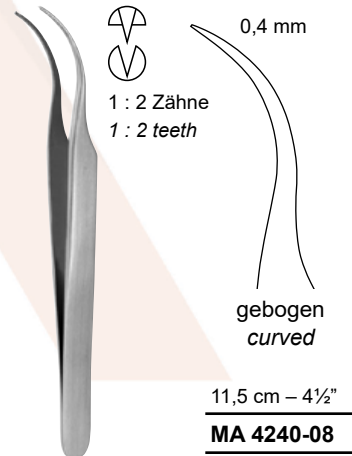
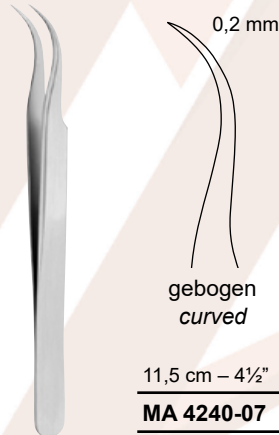
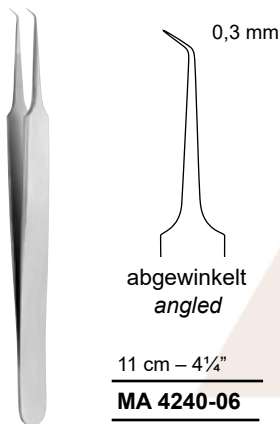
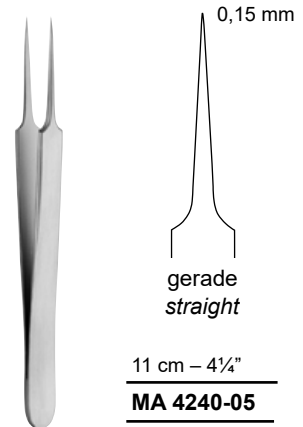
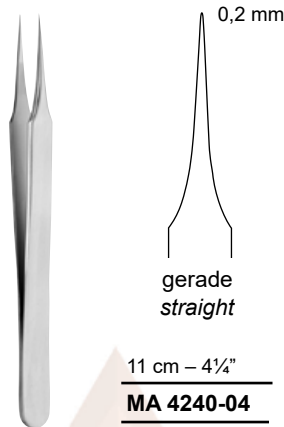
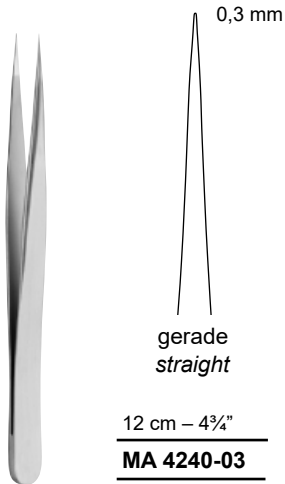

M.ASHRAF
INSTRUMENTS

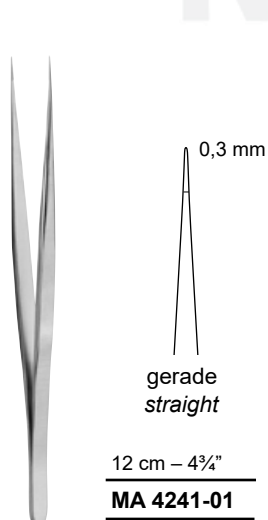

WISE

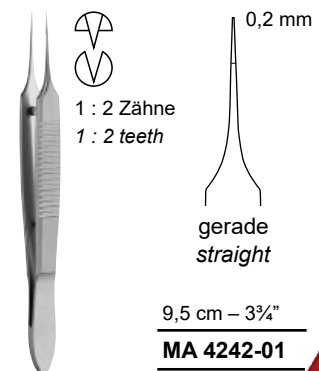
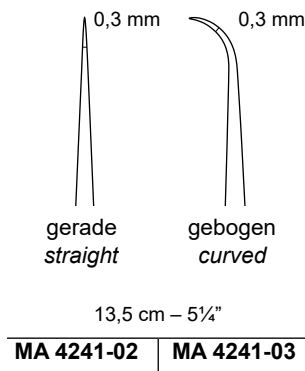

Mikro-Nahtpinzetten Micro Suture Forceps

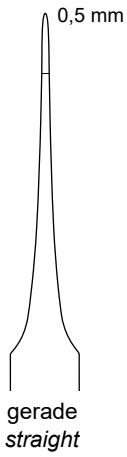

18,5 cm – 7 1/4"
MA 4075-00

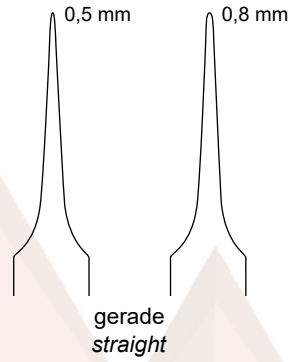

15 cm – 6"
MA 4075-05 | **MA 4075-08**

LAZAR

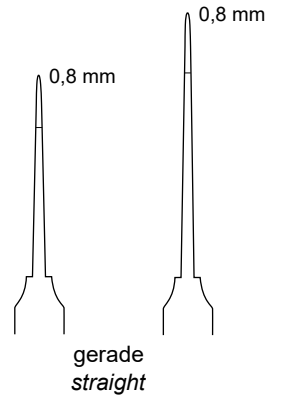

14 cm – 5 1/2" | 18 cm – 7"
MA 4075-14 | **MA 4075-18**

AUSTIN

M.ASHRAF
INSTRUMENTS



12 cm – 4 1/4"
MA 4035-52

ADSON



Typ / Type | 12 cm – 4 3/4"
TC | **MA 4030-12**

Mikro-Nahtpinzetten Micro Suture Forceps



gerade
straight



gebogen
curved



gerade
straight



1 : 2 Zähne 1
: 2 teeth



	Spitze Tip	mit Fadenplatte, 6 mm with tying platform, 6 mm		
12 cm – 4¾"	0,4 mm	MA 4068-12	MA 4069-12	–
15 cm – 6"	0,4 mm	MA 4068-15	MA 4069-15	MA 4068-32
18 cm – 7"	0,4 mm	MA 4068-18	MA 4069-18	MA 4068-42
	0,8 mm	MA 4068-19	MA 4069-19	MA 4068-44
21 cm – 8¼"	0,8 mm	MA 4068-21	MA 4069-21	MA 4068-46

gerade
straight

gebogen
curved

gerade
straight

	Typ Type	Spitze Tip	mit Fadenplatte, 6 mm with tying platform, 6 mm		
18 cm – 7"	TI	0,4 mm	RU 4068-18T	RU 4069-18T	RU 4068-42T
	TI	0,8 mm	RU 4068-19T	RU 4069-19T	RU 4068-44T
21 cm – 8¼"	MC	0,8 mm	RU 4068-22U	RU 4069-22U	–



M.ASHRAF INSTRUMENTS



0,6 mm

gerade
straight



0,6 mm

gebogen
curved



0,6 mm

gerade
straight



1 : 2 Zähne
1 : 2 teeth

	Typ Type	Spitze Tip			
15 cm – 6"	MG	0,6 mm	MA 4068-51G	MA 4068-52G	MA 4068-63G
18 cm – 7"	MG	0,6 mm	MA 4068-53G	MA 4068-54G	–
21 cm – 8¼"	MG	0,6 mm	MA 4068-55G	MA 4068-56G	–

Anatomische Mikro-Pinzetten

Dissecting Micro Forceps

Evolution / Nano

- leichter als Titan dank neuem Griff-Design
- alle Vorzüge von Edelstahlinstrumenten
- außergewöhnlich gute Haptik für präzises Arbeiten
- problemloses Reinigen für bestmögliche Hygiene
- optimale Ergonomie dank der runden Griffschalen

Evolution / Nano

- lighter than titanium thanks to the new handle design
- all advantages of stainless steel instruments
- unsurpassed haptics for precision during the operation
- easy cleaning for best possible hygiene
- optimal ergonomomy due to the round shell handles

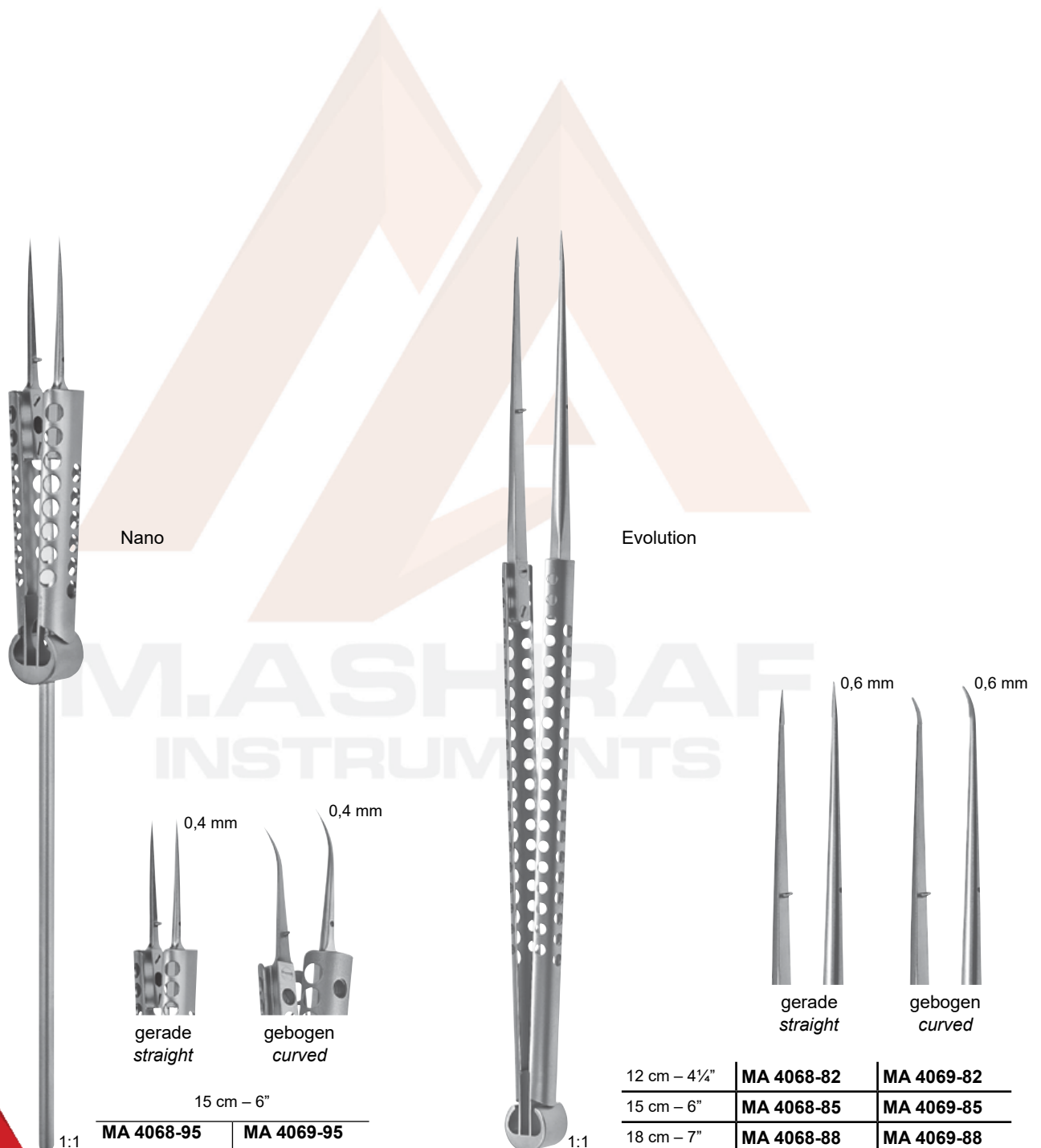

15 cm – 6"	MA 4068-95	MA 4069-95
------------	-------------------	-------------------

12 cm – 4 1/4"	MA 4068-82	MA 4069-82
15 cm – 6"	MA 4068-85	MA 4069-85
18 cm – 7"	MA 4068-88	MA 4069-88

Anatomische Mikro-Pinzetten Dissecting Micro Forceps



YASARGIL

bajonettförmig
bayonet-shaped

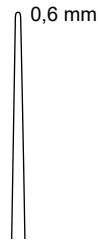

0,6 mm
glatt, gerade
smooth, straight

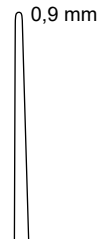

0,9 mm
gerade
straight

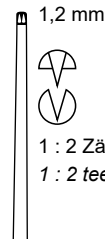

1,2 mm
1 : 2 Zähne
1 : 2 teeth

16 cm – 6¼"	MA 4063-22	MA 4063-24	–
18 cm – 7"	MA 4063-32	MA 4063-34	MA 4063-36
20 cm – 8"	MA 4063-42	MA 4063-44	–
22 cm – 8¾"	MA 4063-52	MA 4063-54	–
24 cm – 9½"	MA 4063-62	MA 4063-64	–

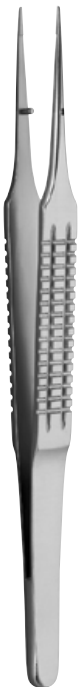

gerade
straight

15 cm – 6"	MA 4065-15
18 cm – 7"	MA 4065-18

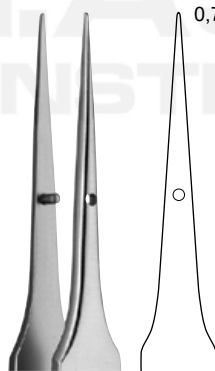

0,7 mm



bajonettförmig
bayonet-shaped

JACOBSEN



gerade
straight

16 cm – 6 ¼"	MA 4078-16
--------------	-------------------

Anatomische Mikro-Pinzetten

Dissecting Micro Forceps



bajonettförmig
bayonet-shaped

HARDY



gerade
straight

21 cm – 8 1/4"

MA 4078-25



bajonettförmig
bayonet-shaped

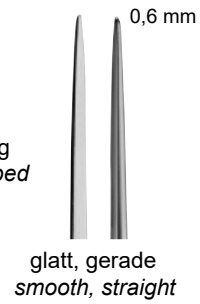

glatt, gerade
smooth, straight

16 cm – 6 1/4"

MA 4296-01

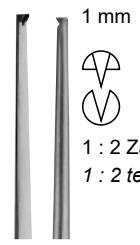

gerade
straight



1 : 2 Zähne
1 : 2 teeth

MA 4296-02



bajonettförmig
bayonet-shaped



glatt, gerade
smooth, straight

18,5 cm – 7 1/4"

MA 4296-06

Anatomische Mikro-Pinzetten

Dissecting Micro Forceps



bajonettförmig
bayonet-shaped

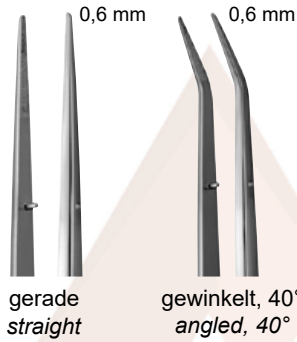

gerade
straight

gewinkelt, 40°
angled, 40°

Typ / Type	19 cm – 7½"	
MG	MA 4078-30G	MA 4078-31G



bajonettförmig
bayonet-shaped



gerade
straight



gerade
straight

A = Ø 1 mm
B = Ø 0,5 mm

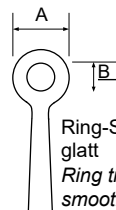

Ring-Spitze
glatt
Ring tip
smooth

Typ / Type	22 cm – 8¾"	
MG	MA 4078-40G	MA 4078-41G

Mikro-Tumorfasspinzetten

Micro Tumor Grasping Forceps



bajonettförmig
bayonet-shaped

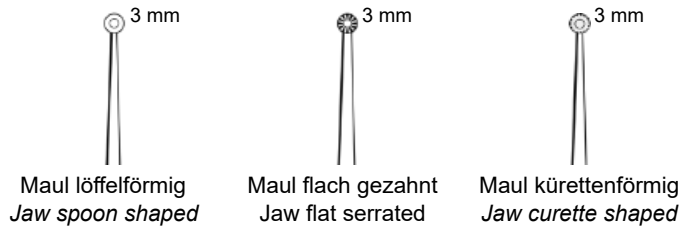

22 cm – 8¾"	MA 4078-01	MA 4078-03	MA 4078-05
-------------	-------------------	-------------------	-------------------

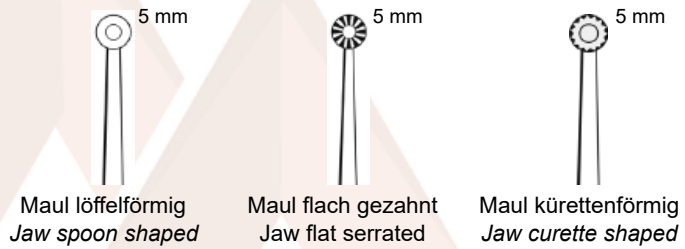

22 cm – 8¾"	MA 4078-02	MA 4078-04	MA 4078-06
-------------	-------------------	-------------------	-------------------



bajonettförmig
bayonet-shaped

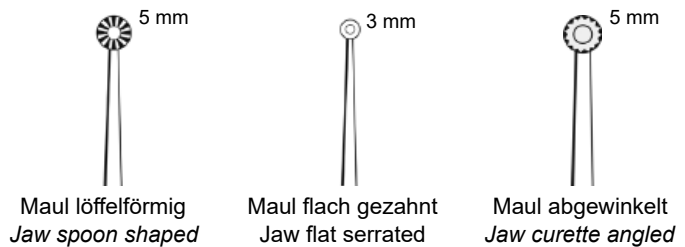

20 cm – 8"	MA 4078-10	MA 4078-11	MA 4078-60
------------	-------------------	-------------------	-------------------

Mikro-Tumorfasspinzetten

Micro Tumor Grasping Forceps



22 cm – 8¾"	MA 4064-51	MA 4064-52	–
24 cm – 9½"	MA 4064-61	MA 4064-62	MA 4064-63



leichter Lochgriff,
bajonettförmig
*light perforated handle,
bayonet-shaped*

YASARGIL



22 cm – 8¾"	MA 4064-54	MA 4064-55
-------------	-------------------	-------------------

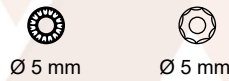

22 cm – 8¾"	MA 4064-57	MA 4064-58
-------------	-------------------	-------------------

M.ASHRAF

INSTRUMENTS

Mikro-Pinzetten, Rundgriff

Micro Forceps, Round Handle

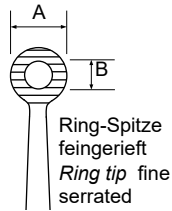
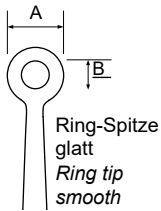

A = Ø 1 mm
B = Ø 0,5 mm

A = Ø 1 mm
B = Ø 0,5 mm

A = Ø 2 mm
B = Ø 1 mm

A = Ø 2 mm B
= Ø 1 mm

Typ
Type

feingerieft
fine serrated

glatt
smooth

feingerieft
fine serrated

glatt
smooth

15 cm – 6"	TI	MA 4079-12	MA 4079-14	–	–
18 cm – 7"		–	–	MA 4079-36	MA 4079-38
18 cm – 7"	TI	MA 4079-32T	MA 4079-34T	MA 4079-36T	MA 4079-38T
22 cm – 8¾"		MA 4079-52	MA 4079-54	MA 4079-56	MA 4079-58



A = Ø 1 mm
B = Ø 0,5 mm

A = Ø 1 mm
B = Ø 0,5 mm

A = Ø 2 mm
B = Ø 1 mm

A = Ø 2 mm
B = Ø 1 mm

Typ
Type

gerade
straight

gebogen
curved

gerade
straight

gebogen
curved

15 cm – 6"	MG	MA 4068-74G	MA 4068-75G	–	–
15 cm – 6"	MG/TI	MA 4079-12U	–	MA 4079-16U	–
18 cm – 7"	MG	MA 4079-32G	MA 4079-33G	MA 4079-36G	MA 4079-37G
18 cm – 7"	MG/TI	MA 4079-32U	–	MA 4079-36U	–
21 cm – 8¾"	MG	MA 4079-42G	MA 4079-43G	MA 4079-46G	MA 4079-47G

Feine anatomische Pinzetten Delicate Dissecting Forceps

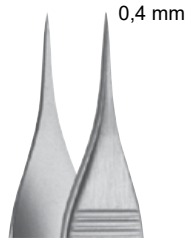

glatt, gerade
smooth, straight

12 cm – 4¾"	MA 4033-12
15,5 cm – 6"	MA 4033-15

JACOBSON-ADSON



fein, glatt,
gerade
*delicate, smooth,
straight*

Typ / Type	12 cm – 4¾"
TC	MA 4130-32

MICRO ADSON



gerade
straight

12 cm – 4¾"	MA 4034-12
15 cm – 6"	MA 4034-15

MICRO ADSON

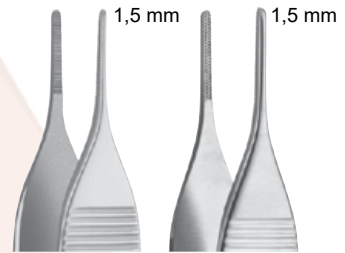

gerade,
kreuzgerieft
*straight,
cross serrated*

12 cm – 4¾"	MA 4035-12	MA 4035-32
15 cm – 6"	MA 4035-15	–

ADSON STANDARD



gerade
straight

12 cm – 4¾"	MA 4032-12
-------------	-------------------

EWALD



kreuzgerieft
cross serrated



Typ
Type

gerade
straight

12 cm – 4¾"	TC	MA 4036-12
15 cm – 6"	TC	MA 4036-15

ADSON

M.ASHRAF
INSTRUMENTS



Feine anatomische Pinzetten Delicate Dissecting Forceps



ADSON



DE BAKEY Zahnung
DE BAKEY Serration



gerade
straight

12,5 cm – 5"	MA 7585-12
15 cm – 6"	MA 7585-15



gerade
straight



leicht gebogen
slightly curved



stark gebogen
strongly curved

10 cm – 4"		
MA 4250-10	MA 4251-10	MA 4252-10



SEMKEN



gerade
straight



gebogen
curved

12,5 cm – 5"	MA 4040-12	MA 4041-12
15 cm – 6"	MA 4040-15	MA 4041-15



SEMKEN

kreuzgerieft
cross serrated



gerade
straight

Typ / Type	15 cm – 6"
TC	MA 4042-15



MC INDOE



gerade
straight

15 cm – 6"	MA 4038-15
------------	-------------------



MC INDOE



gerade
straight

Typ / Type	15 cm – 6"
TC	MA 4039-15

Feine anatomische Pinzetten Delicate Dissecting Forceps



BRAIN



gerade
straight

17,5 cm – 7"

MA 4048-18



WAUGH



gerade
straight

15 cm – 6"

MA 4055-15

18 cm – 7"

MA 4055-18

20 cm – 8"

MA 4055-20



glatt, gerade
smooth, straight

18 cm – 7"

MA 4056-18

20 cm – 8"

MA 4056-20

M.ASHRAF
INSTRUMENTS

Feine anatomische Pinzetten Delicate Dissecting Forceps

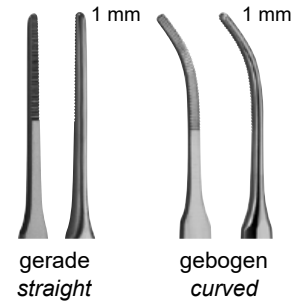

17,5 cm – 7"

Typ / Type	MA 4070-17	MA 4071-17
TI	MA 4070-17T	-



Typ / Type	17,5 cm – 7"
TC	MA 4070-57

Feine anatomische Pinzetten Delicate Dissecting Forceps

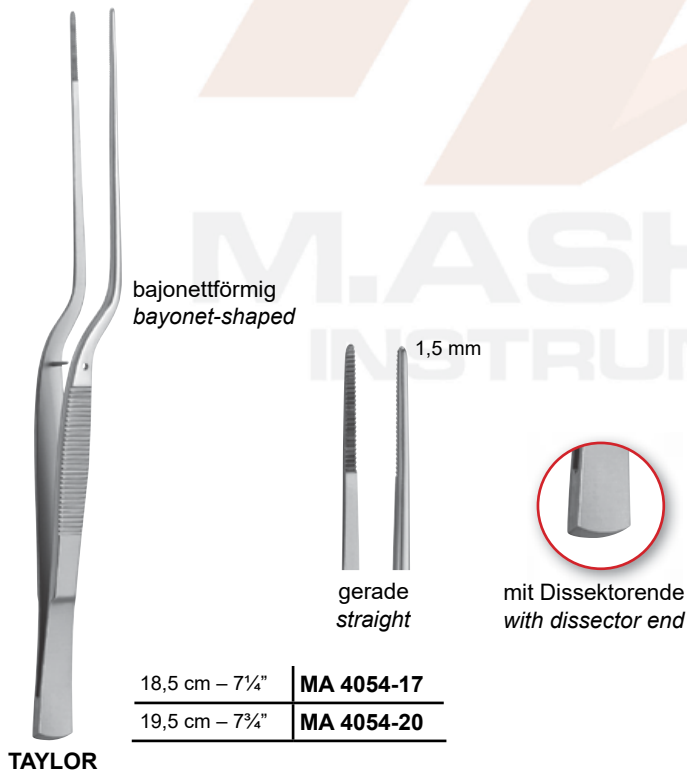
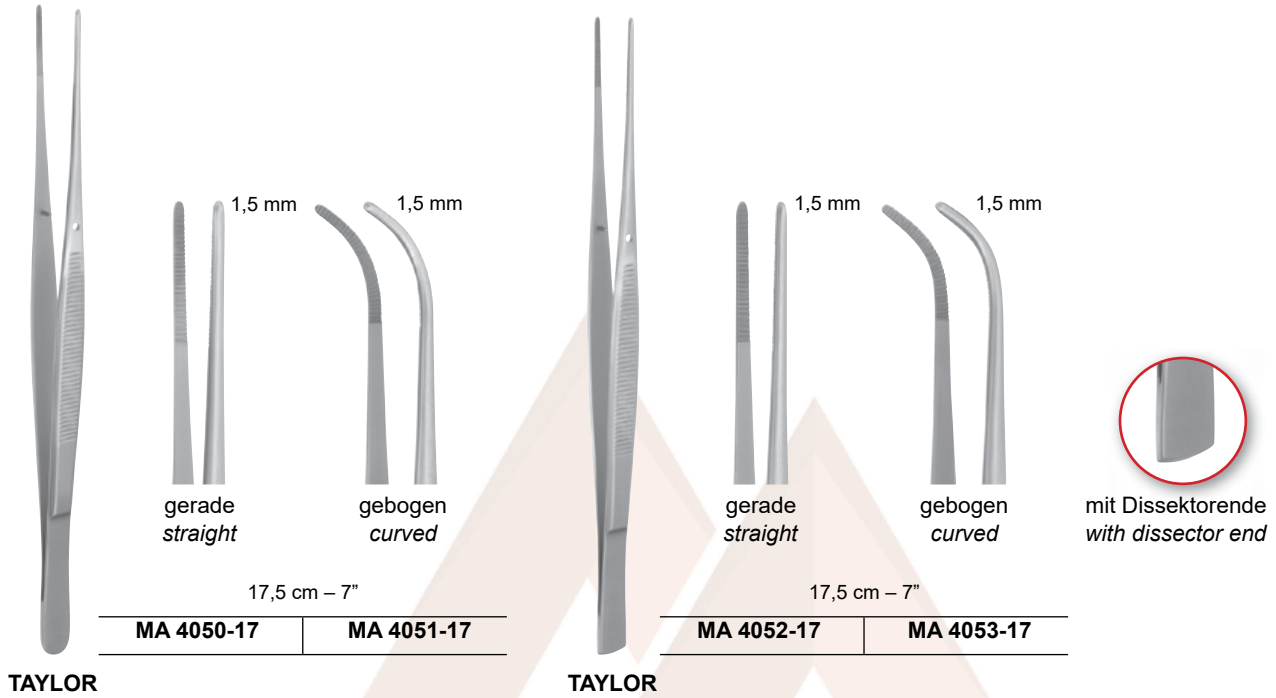

M.ASHRAF
INSTRUMENTS

Feine anatomische Pinzetten Delicate Dissecting Forceps

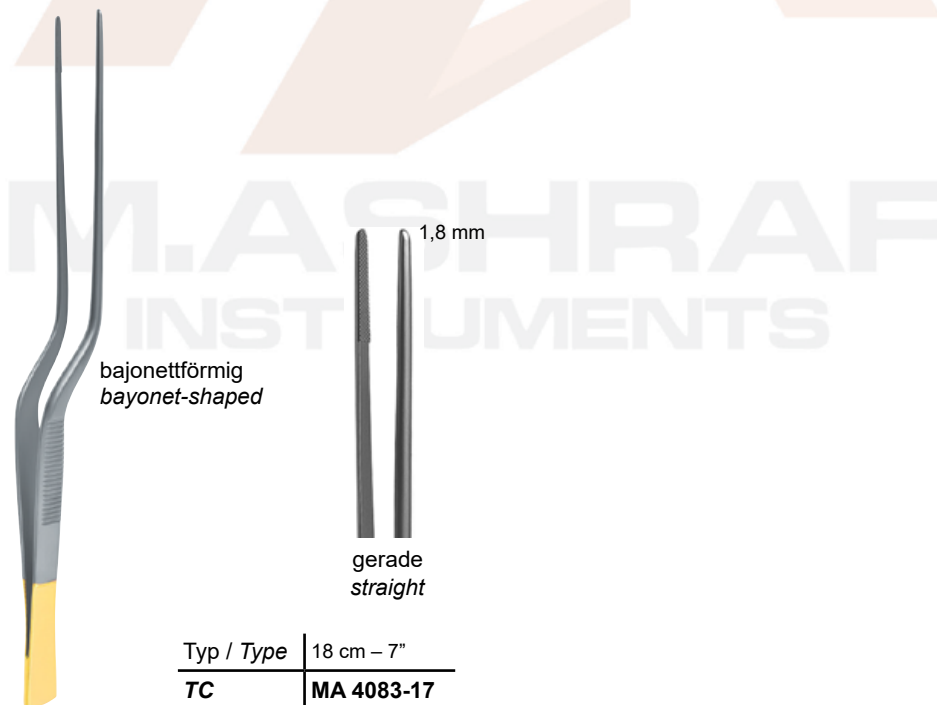
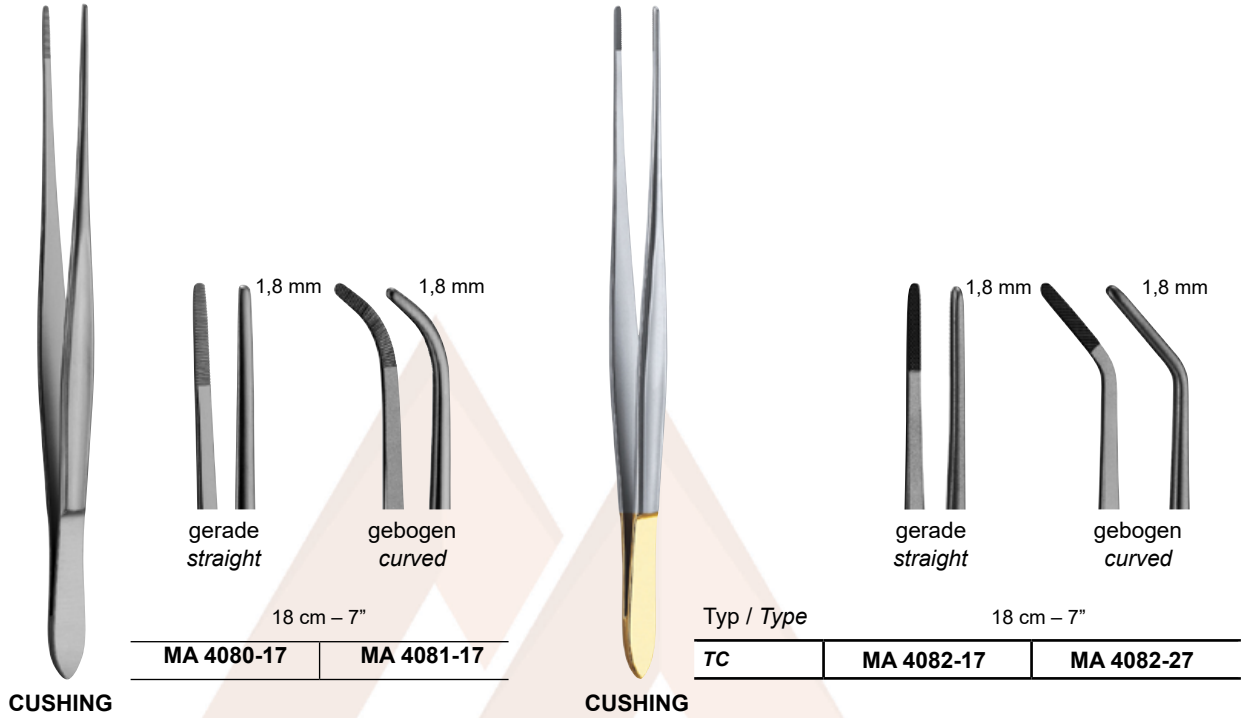

CUSHING-TAYLOR

Feine anatomische Pinzetten Delicate Dissecting Forceps



BROPHY

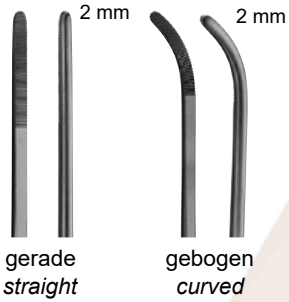

gerade
straight

gebogen
curved

20 cm – 8"

MA 4060-20

MA 4061-20



gewinkelt
angled

20 cm – 8"

MA 4057-20



gerade
straight

20 cm – 8"

MA 4058-20

M.ASHRAF
INSTRUMENTS



Feine anatomische Pinzetten Delicate Dissecting Forceps



POTTS-SMITH

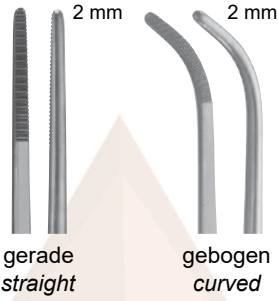

18 cm – 7"	MA 4090-18	MA 4091-18
21 cm – 8¼"	MA 4090-21	MA 4091-21
25 cm – 10"	MA 4090-25	MA 4091-25



POTTS-SMITH



Typ
Type gerade
straight

15 cm – 6"	TC	MA 4092-15
18 cm – 7"	TC	MA 4092-18
20 cm – 8"	TC	MA 4092-20
23 cm – 9"	TC	MA 4092-23
25 cm – 10"	TC	MA 4092-25



GRÜNWALD

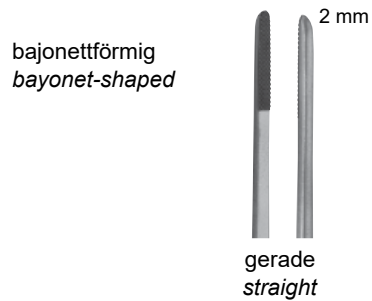

bajonettförmig
bayonet-shaped



gerade
straight

Typ / Type	19 cm – 7½"
TC	MA 4084-18

Anatomische Pinzetten

Dissecting Forceps

Standard

gerade
straight



gebogen
curved

mittelbreit, gerade
medium, straight

mittelbreit, gebogen
medium, curved

10,5 cm – 4¼"	MA 4000-10	–	–	–
11,5 cm – 4½"	MA 4000-11	MA 4001-11	MA 4010-11	MA 4011-11
13 cm – 5"	MA 4000-13	MA 4001-13	MA 4010-13	MA 4011-13
14,5 cm – 5¾"	MA 4000-14	MA 4001-14	MA 4010-14	MA 4011-14
15,5 cm – 6"	MA 4000-15	–	–	–
16 cm – 6¼"	MA 4000-16	MA 4001-16	MA 4010-16	MA 4011-16
18 cm – 7"	MA 4000-18	MA 4001-18	MA 4010-18	MA 4011-18
20 cm – 8"	MA 4000-20	MA 4001-20	MA 4010-20	MA 4011-20
25 cm – 10"	MA 4000-25	MA 4001-25	MA 4010-25	MA 4011-25
30 cm – 11¾"	MA 4000-30	MA 4001-30	MA 4010-30	MA 4011-30

Standard

Typ
Type

gerade
straight

Schwedisches Modell
Swedish pattern

gerade
straight

14,5 cm – 5¾"	TC	MA 4002-14	
16 cm – 6¼"	TC	MA 4002-16	
18 cm – 7"	TC	MA 4002-18	
20 cm – 8"	TC	MA 4002-20	
25 cm – 10"	TC	MA 4002-25	

STILLE

13 cm – 5"	MA 4013-13
15 cm – 6"	MA 4013-15
17 cm – 6¾"	MA 4013-17
20 cm – 8"	MA 4013-20

Anatomische Pinzetten Dissecting Forceps

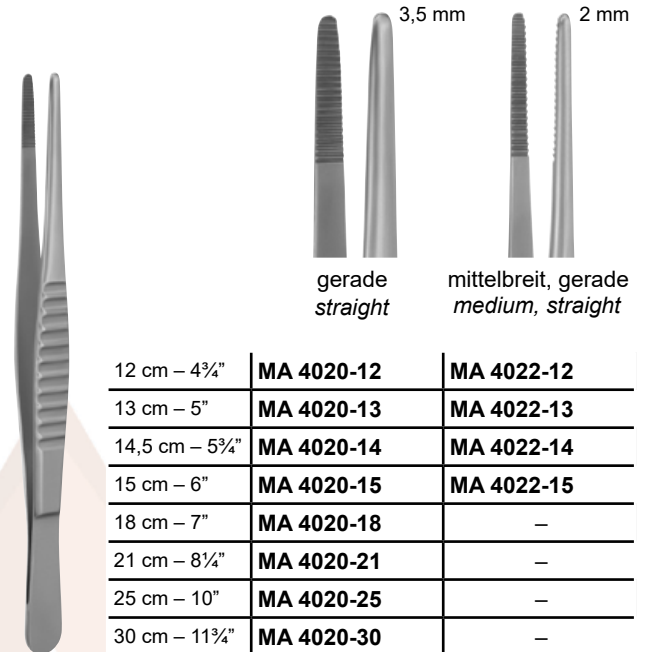
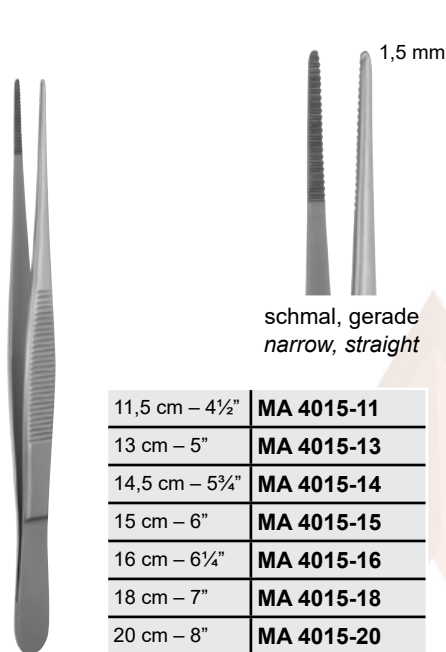

MODELL USA
USA PATTERN



BONNEY



OCHSNER

Anatomische Pinzetten Dissecting Forceps



WANGENSTEIN



Typ
Type gerade
straight

15 cm – 6"	TC	MA 4085-15
23 cm – 9"	TC	MA 4085-23
25 cm – 10"	TC	MA 4085-25



gerade
straight

23 cm – 9"

MA 4086-23



Hypophysenpinzette
Pituitary forceps

bajonettförmig
bayonet-shaped

ADSON



6 mm

gerade
straight

23 cm – 9"

MA 4078-20

M.ASHRAF
INSTRUMENTS

Atraumatische Pinzetten Atraumatic Forceps



DE BAKEY Zahnung
DE BAKEY Serration

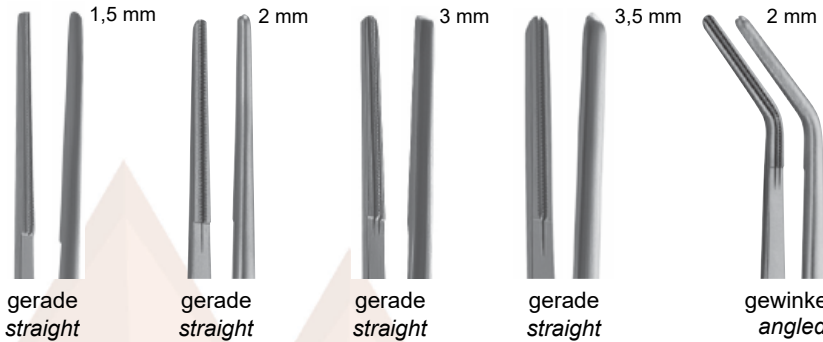

15 cm – 6"	MA 7580-16	MA 7581-16	MA 7582-16	MA 7583-16	MA 7584-16
20 cm – 8"	MA 7580-20	MA 7581-20	MA 7582-20	MA 7583-20	MA 7584-20
24 cm – 9½"	MA 7580-24	MA 7581-24	MA 7582-24	MA 7583-24	MA 7584-24
30 cm – 11¼"	MA 7580-30	MA 7581-30	MA 7582-30	MA 7583-30	MA 7584-30

DE BAKEY



DE BAKEY Zahnung
DE BAKEY Serration



15 cm – 6"	TI	MA 7580-01T	MA 7580-16T	MA 7581-01T	MA 7582-01T	MA 7582-16T
20 cm – 8"	TI	MA 7580-02T	MA 7580-20T	MA 7581-02T	MA 7582-02T	MA 7582-20T
24 cm – 9½"	TI	MA 7580-03T	MA 7580-24T	MA 7581-03T	MA 7582-03T	MA 7582-24T

DE BAKEY

Ohrpinzetten Ear Dressing Forceps



	14 cm – 5½"	
1 mm	MA 7862-24	MA 7863-14
2 mm	MA 7862-14	–



	2 mm
gerade, gezahnt, gerieft straight, toothed, serrated	
14 cm – 5½"	
MA 7863-15	



	2,2 mm	1 mm
16 cm – 6¼"	MA 7864-16	MA 7864-26
19,5 cm – 7¾"	MA 7864-18	MA 7864-28
21 cm – 8¼"	MA 7864-20	MA 7864-30

JANSEN-GRUENWALD



	2 mm
16 cm – 6¼"	
MA 7865-16	
20 cm – 8"	
MA 7865-20	

JANSEN

Ohrpinzetten Ear Dressing Forceps

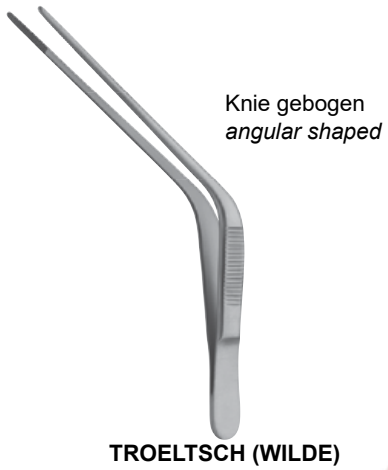

10,5 cm – 4¼"	MA 7860-11
11,5 cm – 4½"	MA 7860-12
15 cm – 6"	MA 7860-15
18 cm – 7"	MA 7860-18

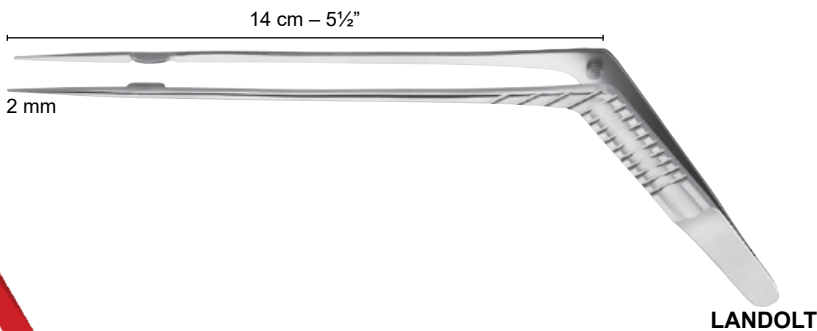
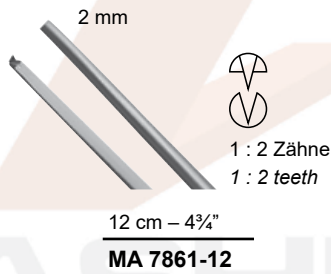
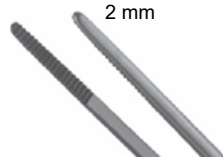

Feine chirurgische Pinzetten Delicate Tissue Forceps

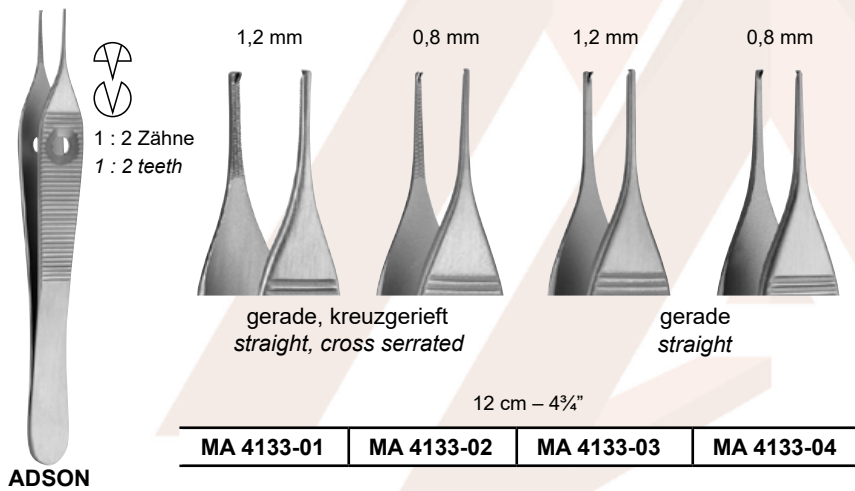
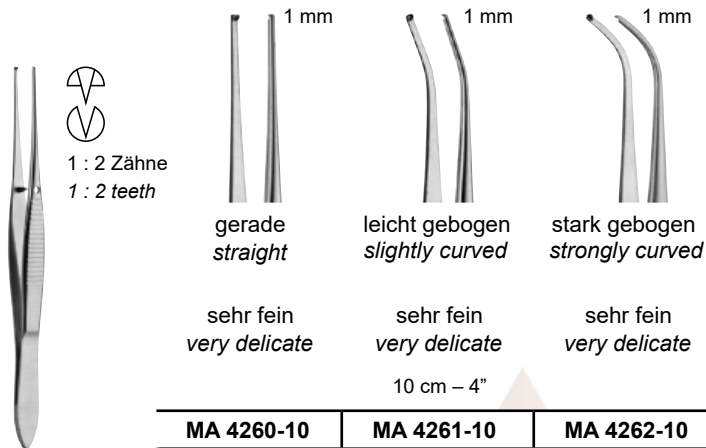

ADSON

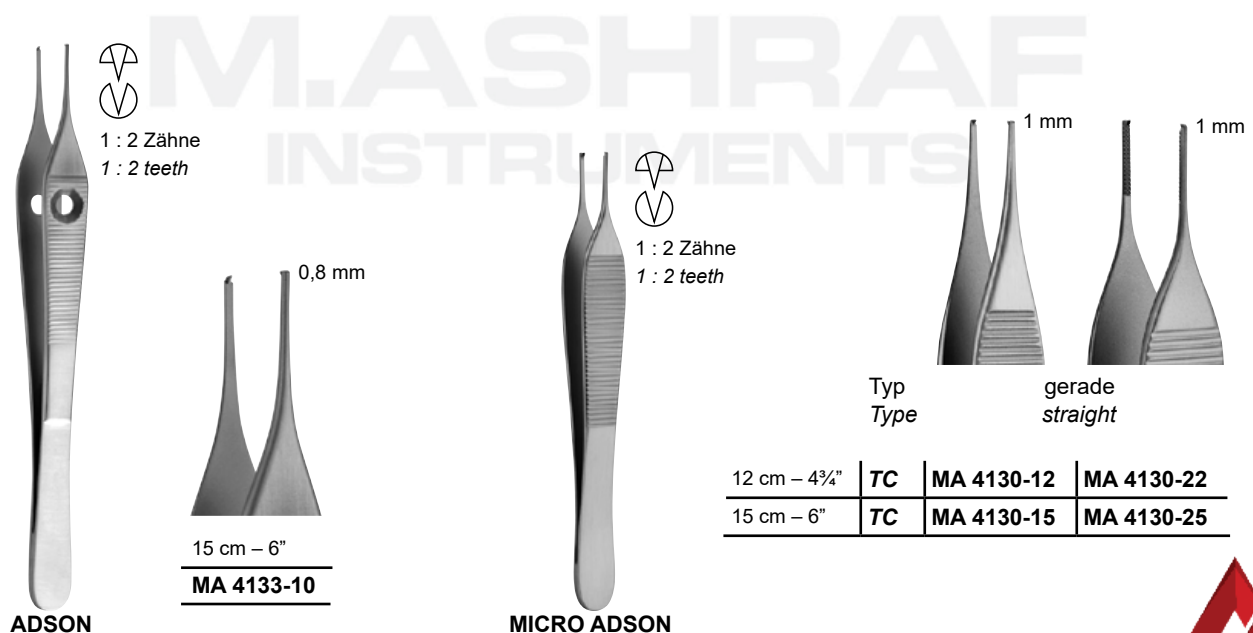

Feine chirurgische Pinzetten Delicate Tissue Forceps



kniegebogen
curved

12 cm – 4¾"

MA 4135-72

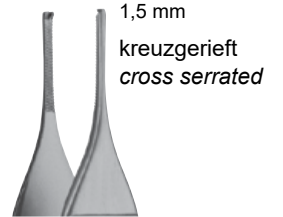

12 cm – 4¾"

MA 4136-12

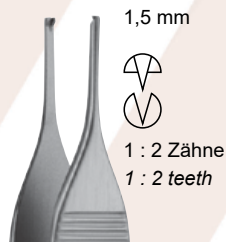

12 cm – 4¾"

MA 4135-12

15 cm – 6"

MA 4135-15

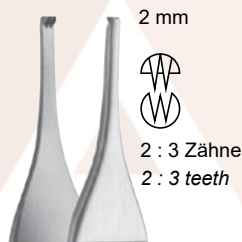

MA 4135-52

MA 4135-55



12 cm – 4¾"

MA 4132-12

M.ASHRAF
INSTRUMENTS



Typ gerade
Type straight

12 cm – 4¾"

TC MA 4134-12

15 cm – 6"

TC MA 4134-15

Feine chirurgische Pinzetten Delicate Tissue Forceps

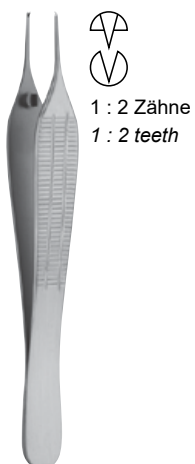

1 : 2 Zähne
1 : 2 teeth



0,8 mm
Zähne schräggestellt
Teeth in oblique position

12 cm – 4¾"

MA 4131-12

MICRO-ADSON-BIEMER



1 : 2 Zähne
1 : 2 teeth

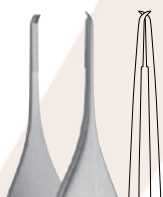

kreuzgerieft
cross serrated

12 cm – 4¾"

MA 4136-72

ADSON



1 : 2 Zähne
1 : 2 teeth

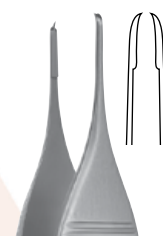

1 mm

12 cm – 4¾"

MA 4135-82

ADSON



1 : 2 Zähne
1 : 2 teeth



0,6 mm

gerade
straight



0,8 mm

gerade
straight



1 mm

gerade
straight

15 cm – 6"

MA 4147-01

MA 4147-02

MA 4147-03

M.ASHRAF
INSTRUMENTS

Feine chirurgische Pinzetten Delicate Tissue Forceps

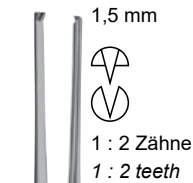

SEMKEN

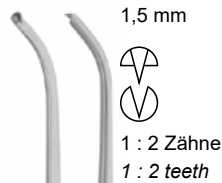

SEMKEN

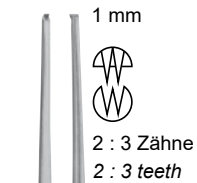

MICRO-SEMKEN

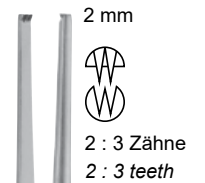

MICRO-SEMKEN

12,5 cm – 5"	MA 4140-12	MA 4141-12	MA 4140-30	MA 4142-12
15 cm – 6"	MA 4140-15	MA 4141-15	MA 4140-31	MA 4142-15

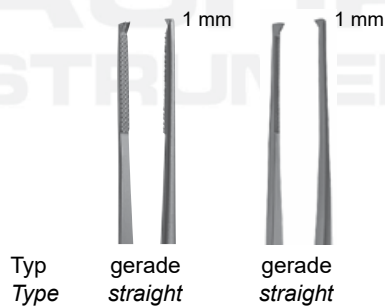

14,5 cm – 5"	TC	MA 4140-24	–
16 cm – 6¼"	TC	–	MA 4140-26
18 cm – 7"	TC	MA 4140-28	–

MICRO-SEMKEN

Feine chirurgische Pinzetten Delicate Tissue Forceps



Typ / Type	15,5 cm – 6"
	MA 4138-15
TI	MA 4138-15T



Typ / Type	15,5 cm – 6"
	MA 4138-65
TC	MA 4138-65



	15 cm – 6"
	MA 4138-75



	17,5 cm – 7"
	MA 4148-18

Feine chirurgische Pinzetten Delicate Tissue Forceps

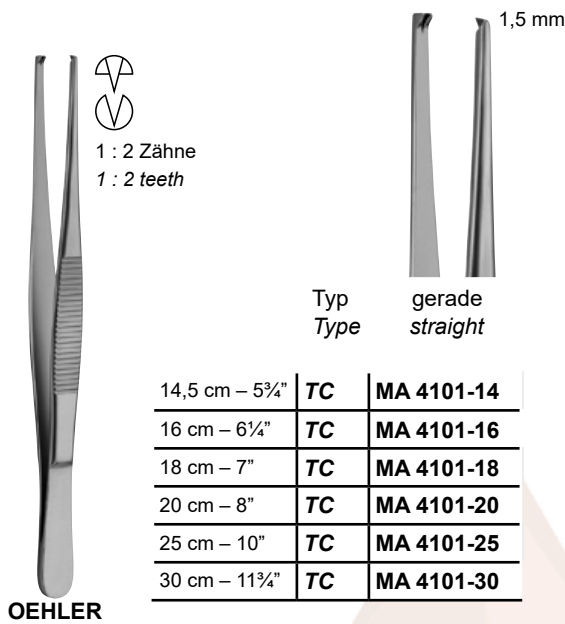

1 : 2 Zähne
1 : 2 teeth

1,5 mm

Typ
Type

gerade
straight

14,5 cm – 5¾"	TC	MA 4101-14
16 cm – 6¼"	TC	MA 4101-16
18 cm – 7"	TC	MA 4101-18
20 cm – 8"	TC	MA 4101-20
25 cm – 10"	TC	MA 4101-25
30 cm – 11¾"	TC	MA 4101-30

OEHLER

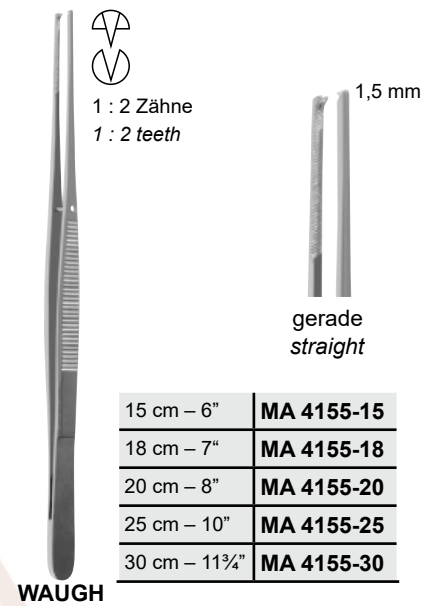

1 : 2 Zähne
1 : 2 teeth

1,5 mm

gerade
straight

15 cm – 6"	MA 4155-15
18 cm – 7"	MA 4155-18
20 cm – 8"	MA 4155-20
25 cm – 10"	MA 4155-25
30 cm – 11¾"	MA 4155-30

WAUGH

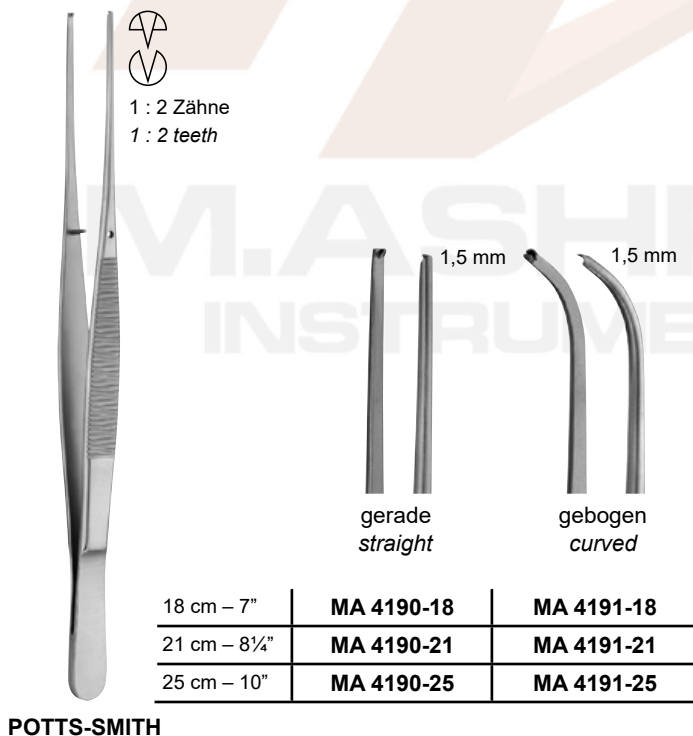

1 : 2 Zähne
1 : 2 teeth

1,5 mm

1,5 mm

gerade
straight

gebogen
curved

18 cm – 7"	MA 4190-18	MA 4191-18
21 cm – 8¼"	MA 4190-21	MA 4191-21
25 cm – 10"	MA 4190-25	MA 4191-25

POTTS-SMITH

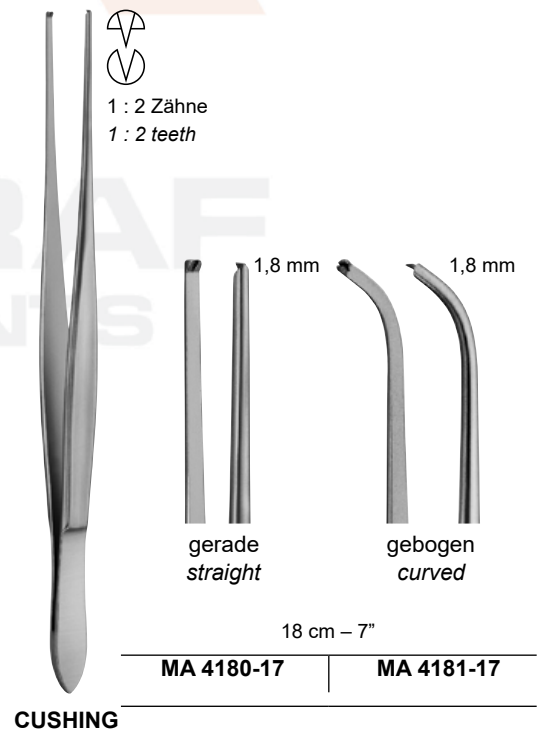

1 : 2 Zähne
1 : 2 teeth

1,8 mm

1,8 mm

gerade
straight

gebogen
curved

18 cm – 7"	MA 4180-17	MA 4181-17
------------	------------	------------

CUSHING

Feine chirurgische Pinzetten Delicate Tissue Forceps

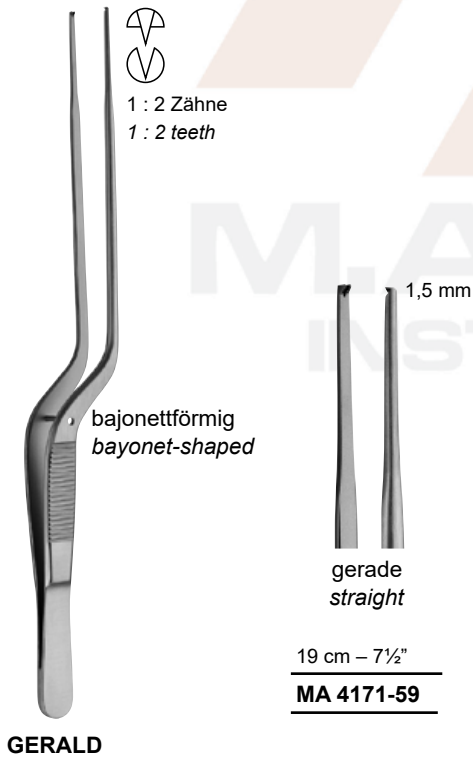
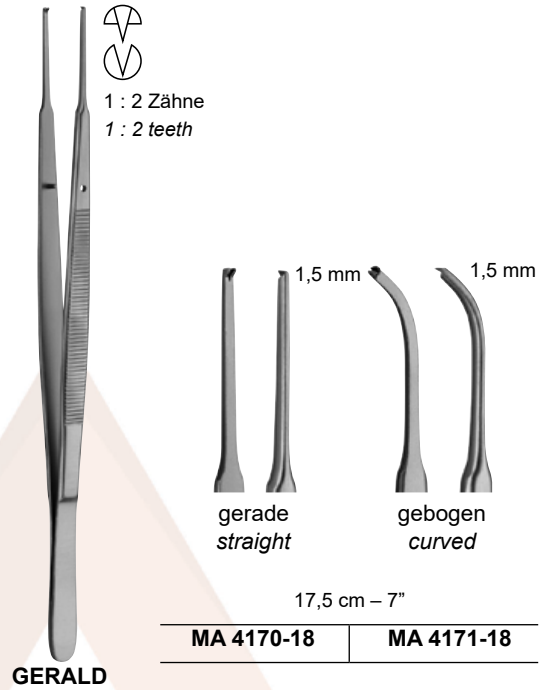
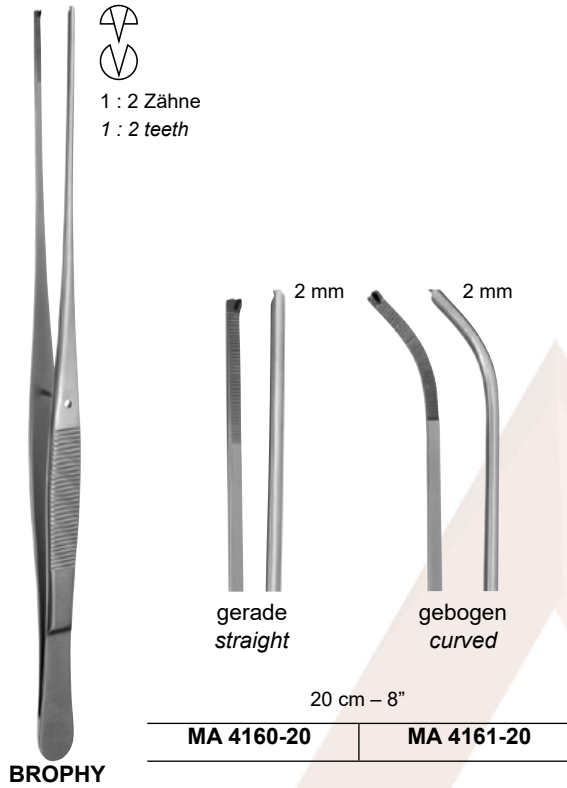

M.ASHRAF
INSTRUMENTS

Feine chirurgische Pinzetten Delicate Tissue Forceps

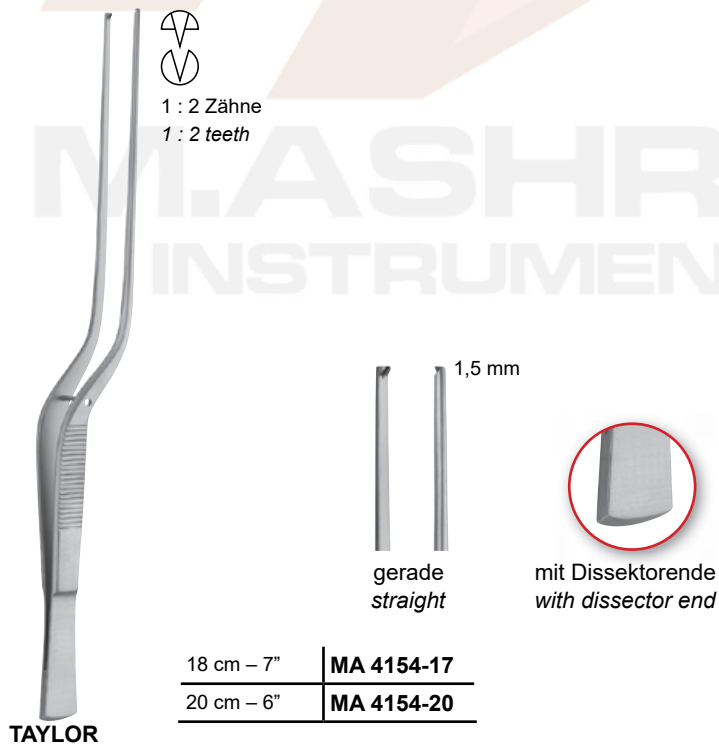
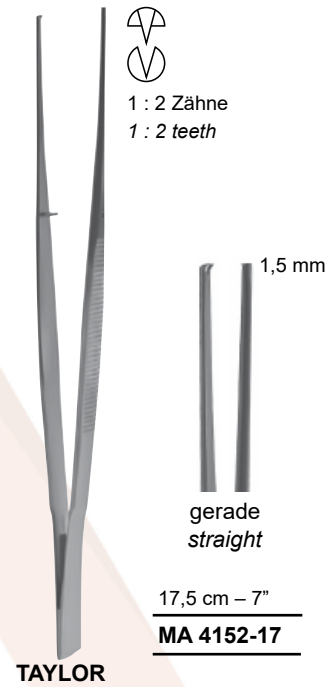

Chirurgische Pinzetten Tissue Forceps



1 : 2 Zähne
1 : 2 teeth

Standard Modell
Standard pattern



gerade
straight

10,5 cm – 4¼"	MA 4100-10
11,5 cm – 4½"	MA 4100-11
13 cm – 5"	MA 4100-13
14,5 cm – 5¾"	MA 4100-14
15,5 cm – 6"	MA 4100-15
16 cm – 6¼"	MA 4100-16
18 cm – 7"	MA 4100-18
20 cm – 8"	MA 4100-20
25 cm – 10"	MA 4100-25
30 cm – 11¾"	MA 4100-30



1 : 2 Zähne
1 : 2 teeth



mittelbreit, gerade
medium, straight



mittelbreit, gebogen
medium, curved

11,5 cm – 4½"	MA 4110-11	–
13 cm – 5"	MA 4110-13	–
14,5 cm – 5¾"	MA 4110-14	MA 4111-14
15,5 cm – 6"	–	–
16 cm – 6¼"	MA 4110-16	–
18,5 cm – 7¼"	MA 4110-18	–
20 cm – 8"	MA 4110-20	–
25 cm – 10"	MA 4110-25	–



1 : 2 Zähne
1 : 2 teeth



gerade
straight

16 cm – 6¼"

MA 4109-16

Chirurgische Pinzetten

Tissue Forceps



Standard Modell
Standard pattern



3 mm



2 : 3 Zähne
2 : 3 teeth

gerade
straight



4,5 mm



3 : 4 Zähne
3 : 4 teeth

gerade
straight

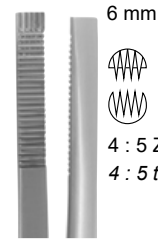

6 mm



4 : 5 Zähne
4 : 5 teeth

gerade
straight

11,5 cm – 4½"	–	MA 4103-13	–
13 cm – 5"	MA 4102-13	MA 4103-14	MA 4104-13
14,5 cm – 5¾"	MA 4102-14	–	MA 4104-14
15,5 cm – 6"	–	MA 4103-16	–
16 cm – 6¼"	MA 4102-16	–	MA 4104-16
18 cm – 7"	MA 4102-18	–	–
20 cm – 8"	MA 4102-20	MA 4103-20	–
25 cm – 10"	MA 4102-25	–	–
30 cm – 11¾"	MA 4102-30	–	–



MODELL USA
USA PATTERN

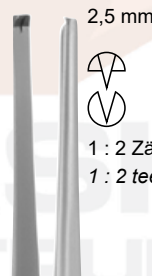

2,5 mm



1 : 2 Zähne
1 : 2 teeth

gerade
straight



3 mm



2 : 3 Zähne
2 : 3 teeth

gerade
straight

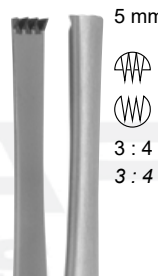

5 mm



3 : 4 Zähne
3 : 4 teeth

gerade
straight

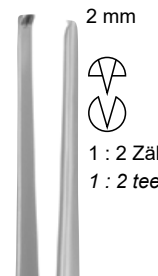

2 mm



1 : 2 Zähne
1 : 2 teeth

schmal, gerade
narrow, straight

12 cm – 4¾"	MA 4120-12	MA 4122-12	–	–
13 cm – 5"	MA 4120-13	MA 4122-13	–	MA 4126-13
14,5 cm – 5¾"	MA 4120-14	MA 4122-14	MA 4123-14	MA 4126-14
15,5 cm – 6"	MA 4120-15	–	–	MA 4126-15
18,5 cm – 7¼"	MA 4120-18	MA 4122-18	–	–
21 cm – 8¼"	MA 4120-21	MA 4122-21	–	–
25 cm – 10"	MA 4120-25	MA 4122-25	–	–
31 cm – 12¼"	MA 4120-31	MA 4122-31	–	–

Chirurgische Pinzetten Tissue Forceps

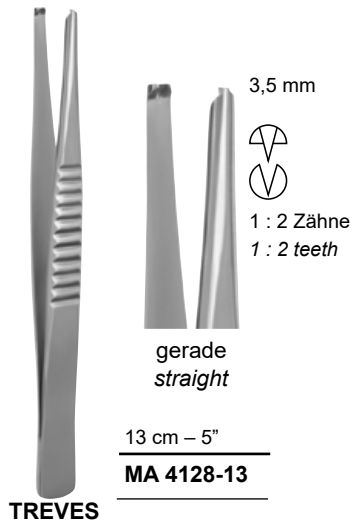

TREVES

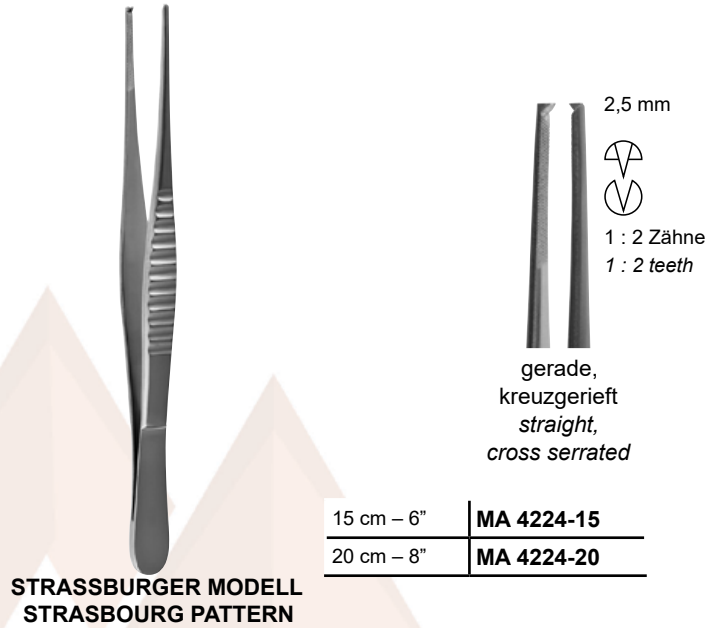

STRASSBURGER MODELL
STRASBOURG PATTERN

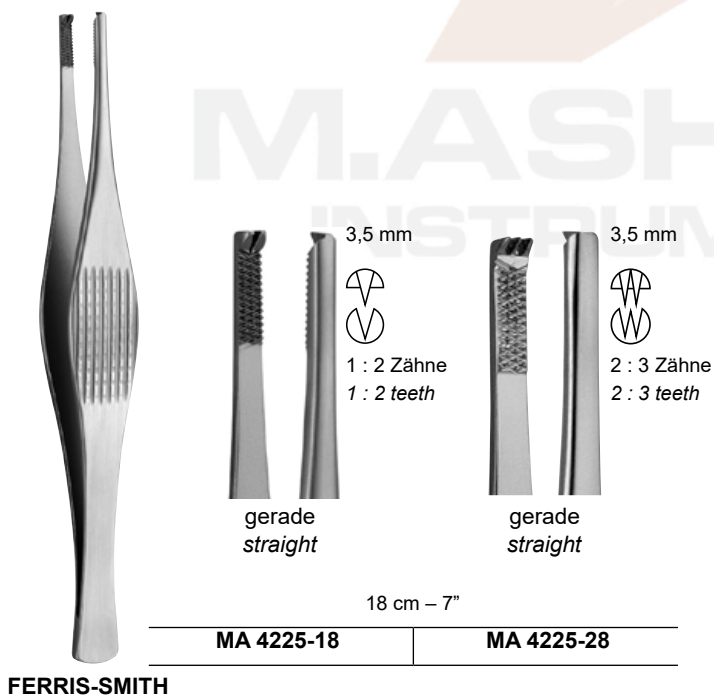

FERRIS-SMITH

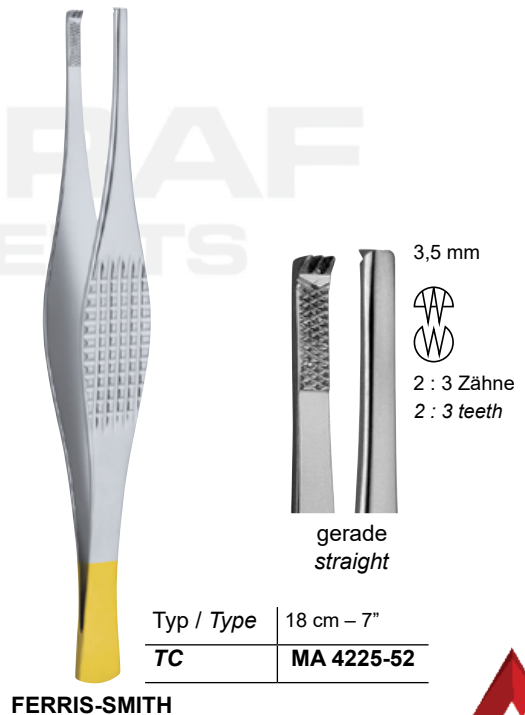

FERRIS-SMITH

Chirurgische Pinzetten Tissue Forceps



LANE

14,5 cm – 5¾"	MA 4226-14	MA 4227-14
20 cm – 8"	MA 4226-20	MA 4227-20



STILLE-BARRAYA

18 cm – 7"	MA 4228-18	
20 cm – 8"	MA 4228-20	
25 cm – 10"	MA 4228-25	



4 mm
1 : 2 Zähne
1 : 2 teeth

gerade
straight



4,5 mm
2 : 3 Zähne
2 : 3 teeth

gerade
straight



3 mm
3 : 4 Zähne
3 : 4 teeth

gerade,
kreuzgerieft
straight,
cross serrated



BONNEY

	MA 4229-18	MA 4230-18
--	-------------------	-------------------



NEW ORLEANS

15 cm – 6"	MA 4144-15	MA 4145-15
20 cm – 8"	MA 4144-20	MA 4145-20
25 cm – 10"	MA 4144-25	MA 4145-25



4 mm
1 : 2 Zähne
1 : 2 teeth



4 mm
2 : 3 Zähne
2 : 3 teeth



2,5 mm
2 : 3 Zähne
2 : 3 teeth

gerade
straight



4,0 mm
4 : 5 Zähne
4 : 5 teeth

gerade
straight



C

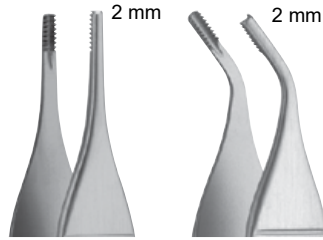
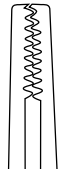

gerade
straight

gebogen
curved

12 cm – 4¾"	MA 4137-12	MA 4137-72
15 cm – 6"	MA 4137-15	–

ADSON-BROWN



gerade
straight

Typ / Type	12 cm – 4¾"
TC	MA 4137-62

ADSON-BROWN



gerade
straight

15 cm – 6"	MA 4026-15
------------	-------------------

COTTLE



gerade
straight

15 cm – 6"	MA 4139-15
20 cm – 6"	MA 4139-20
25 cm – 10"	MA 4139-25

BROWN



gerade
straight

12 cm – 4¾"	MA 4137-82
-------------	-------------------

ADSON-GRAEFE

M.ASHRAF
INSTRUMENTS

Darm- und Lungenpinzetten Intestinal and Lung Forceps

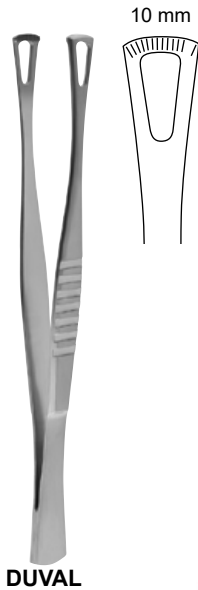

gerade
straight

14,5 cm – 5¾"

MA 4215-14

DUVAL

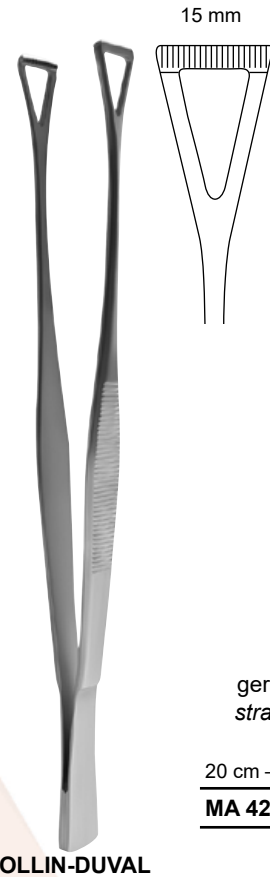

gerade
straight

20 cm – 8"

MA 4216-20

COLLIN-DUVAL



7 mm

gerade
straight

15 cm – 6" | **MA 4235-15**

18 cm – 7" | **MA 4235-18**

23 cm – 9" | **MA 4235-23**

NELSON

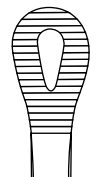

gerade
straight

18 cm – 7" | **MA 4236-18**

23 cm – 9" | **MA 4236-23**

SINGLEY-TUTTLE

Fasspinzetten Grasping Forceps



DURANTE



gerade
straight

14,5 cm – 5¾"	MA 4219-14
16 cm – 6¼"	MA 4219-16
20 cm – 8"	MA 4219-20



**RUSSISCHES MODELL
RUSSIAN PATTERN**



gerade
straight

15 cm – 6"	MA 4220-15
20 cm – 8"	MA 4220-20
25 cm – 10"	MA 4220-25



MAYO



gerade
straight

23 cm – 9"	MA 4221-23
------------	-------------------

Splitterpinzetten Splinter Forceps



gerade, glatt
straight, smooth



gebogen, glatt
curved, smooth

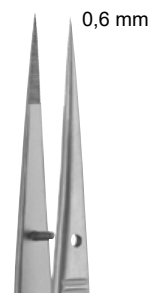

gerade
straight



gebogen
curved

8 cm – 3¼"	MA 4290-08	MA 4291-08	MA 4292-08	MA 4293-08
9 cm – 3½"	MA 4290-09	MA 4291-09	MA 4292-09	MA 4293-09
10,5 cm – 4¼"	MA 4290-10	MA 4291-10	MA 4292-10	MA 4293-10
11,5 cm – 4½"	MA 4290-11	MA 4291-11	MA 4292-11	MA 4293-11
12,5 cm – 5"	MA 4290-12	MA 4291-12	MA 4292-12	MA 4293-12
14,5 cm – 5¾"	–	–	MA 4270-05	MA 4270-15



FEILCHENFELD



gerade
straight

7,5 cm – 3"	MA 4320-07
9 cm – 3½"	MA 4320-09
11,5 cm – 4½"	MA 4320-11

M.ASHRAF
INSTRUMENTS



HUNTER



gerade
straight



gebogen
curved

10,5 cm – 4¼"

MA 4340-10	MA 4341-10
-------------------	-------------------



WALTER-CARMALT



gerade
straight



gebogen
curved

10,5 cm – 4¼"

MA 4350-10	MA 4351-10
-------------------	-------------------

Splitterzangen Splinter Forceps

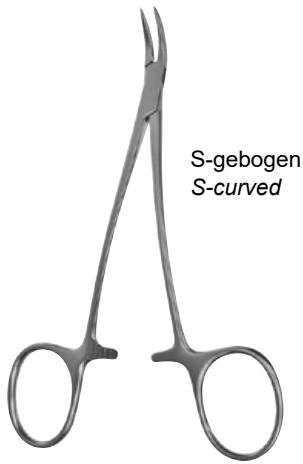

S-gebogen
S-curved

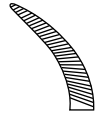

11 cm – 4¼"

MA 4358-11

PEET



STIEGLITZ



gerade,
ohne Sperre
straight,
without ratchet



gerade,
mit Sperre
straight, with
ratchet



gebogen,
ohne Sperre
curved,
without ratchet



gebogen,
mit Sperre
curved, with
ratchet

13,5 cm – 5¼"

MA 4359-13

MA 4360-13

MA 4362-13

MA 4361-13



RALK

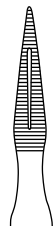

gerade
straight

15 cm – 6"

MA 4364-15



RALK

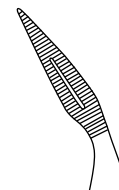

abgewinkelt 45°
angled 45°

15 cm – 6"

MA 4365-15

M.ASHRAF
INSTRUMENTS

Cilienpinzetten Cilia Forceps



SCHAAF

MA 4375-09

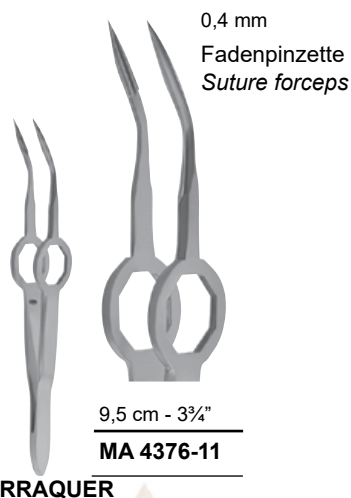

BARRAQUER

MA 4376-11

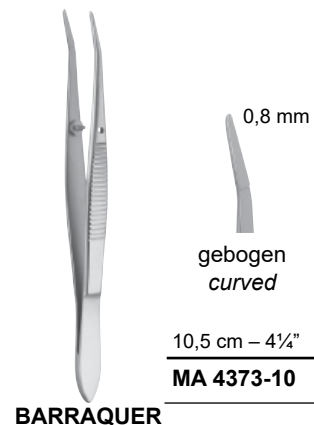

BARRAQUER

MA 4373-10



HENRY

MA 4371-12



GRADLE

MA 4372-09

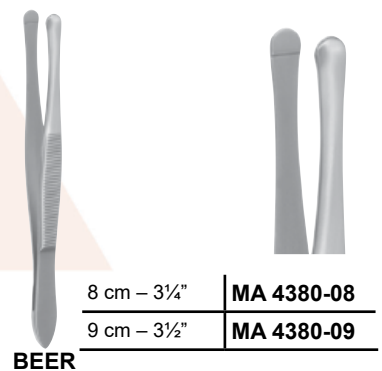

BEER

MA 4380-08

MA 4380-09

M.ASHRAF
INSTRUMENTS

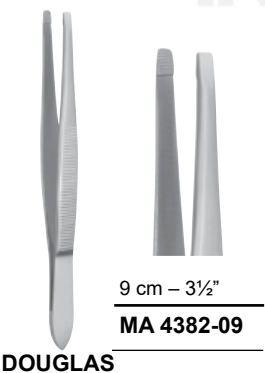

DOUGLAS

MA 4382-09



MA 4386-09

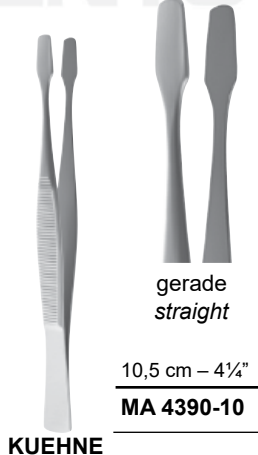

KUEHNE

MA 4390-10

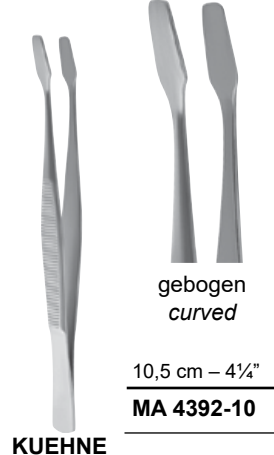

KUEHNE

MA 4392-10



FOUR



Klemmen und Zangen Clamps and Forceps

Arterienklemmen	<i>Hemostatic forceps</i>	CF 1 - 25
Ligaturklemmen	<i>Ligature Forceps</i>	CF 26 - 39
Klemmzangen	<i>Clamp Forceps</i>	CF 40 - 41
Peritoneumklemmen	<i>Peritoneal Forceps</i>	CF 42 - 44
Tuchklemmen	<i>Towel Forceps</i>	CF 45 - 48
Schlauchklemmen	<i>Tubing Forceps</i>	CF 49 - 50
Kornzangen	<i>Dressing Forceps</i>	CF 51 - 53
Tupferzangen	<i>Cotton Swab Forceps</i>	CF 54 - 55
Schwammzangen	<i>Sponge Holding Forceps</i>	CF 56 - 57
Bulldogklemmen	<i>Bulldog Clamps</i>	CF 58 - 61

Arterienklemmen Hemostatic Forceps

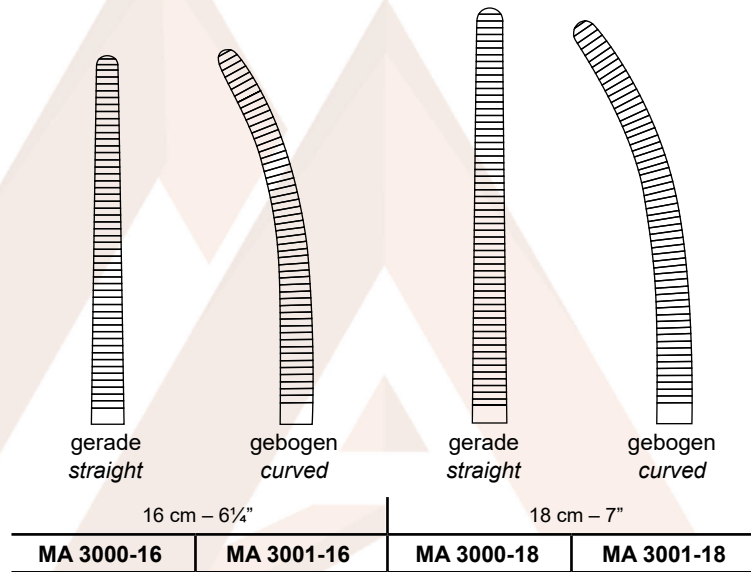
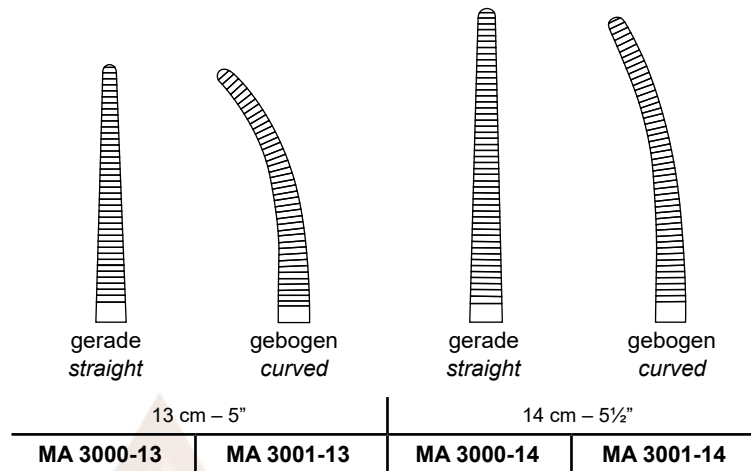

ROCHESTER-PEAN

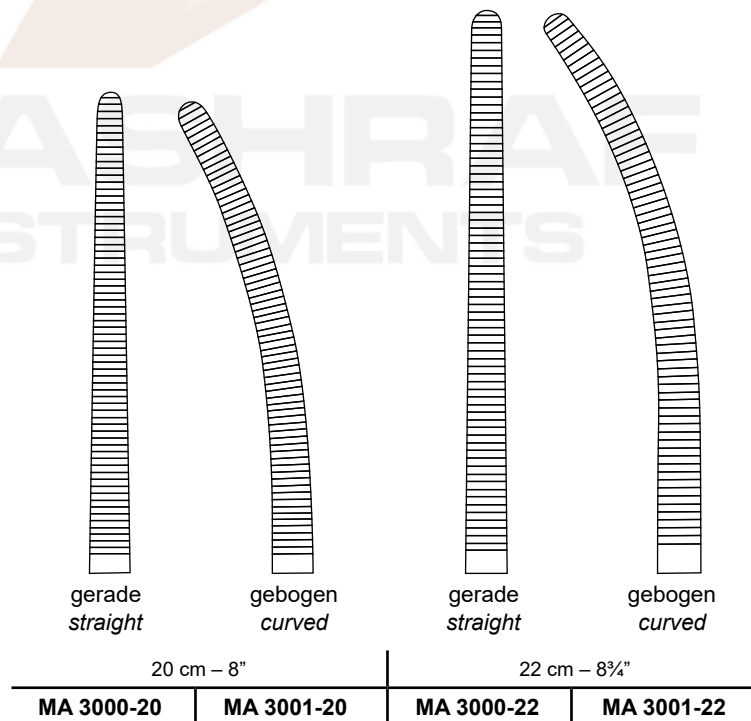

Arterienklemmen Hemostatic Forceps



ROCHESTER-PEAN

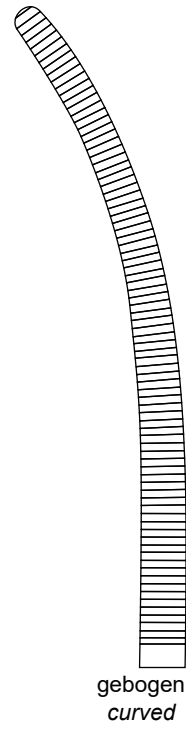
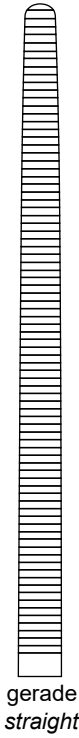
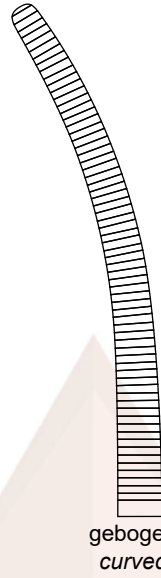

24 cm – 9½"

26 cm – 10¼"

MA 3000-24

MA 3001-24

MA 3000-26

MA 3001-26



ROCHESTER-PEAN

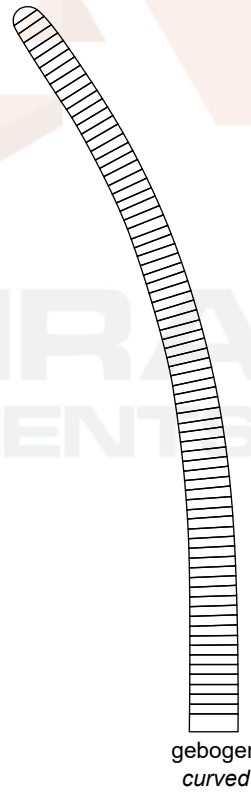

30 cm – 11¾"

MA 3000-30

MA 3001-30

Arterienklemmen Hemostatic Forceps

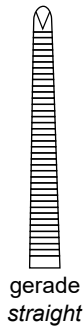

gerade
straight



gebogen
curved



gerade
straight



gebogen
curved

13 cm – 5"

14 cm – 5½"

MA 3010-13

MA 3011-13

MA 3010-14

MA 3011-14



1 : 2 Zähne
1 : 2 teeth



OCHSNER-KOCHER



gerade
straight



gebogen
curved



gerade
straight

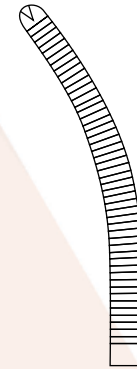

gebogen
curved

16 cm – 6¼"

18 cm – 7"

MA 3010-16

MA 3011-16

MA 3010-18

MA 3011-18

M.ASHRAF
INSTRUMENTS

Arterienklemmen Hemostatic Forceps

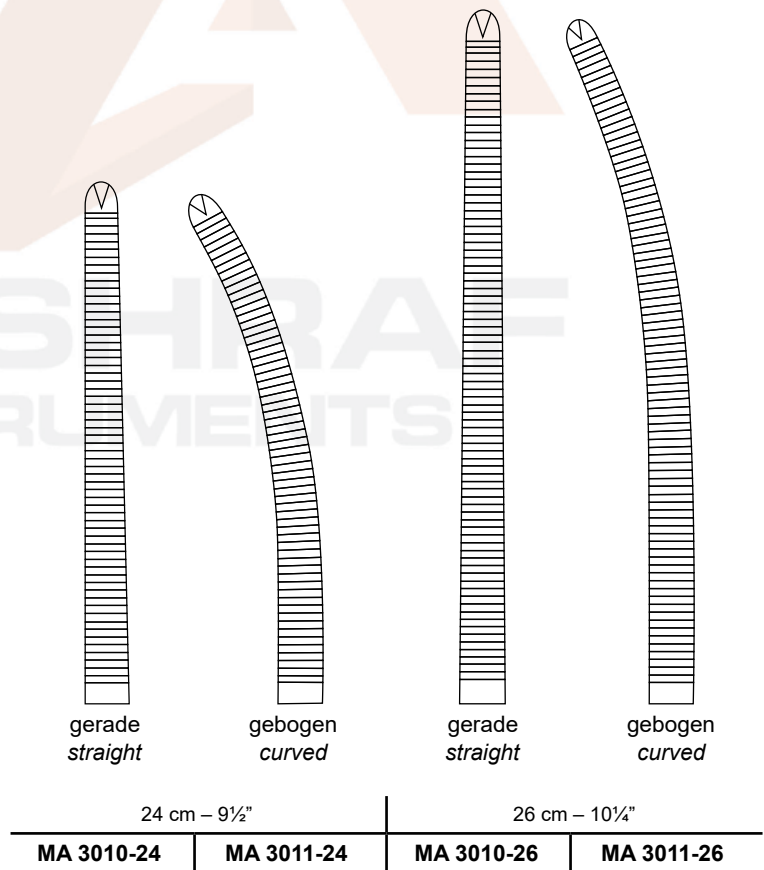
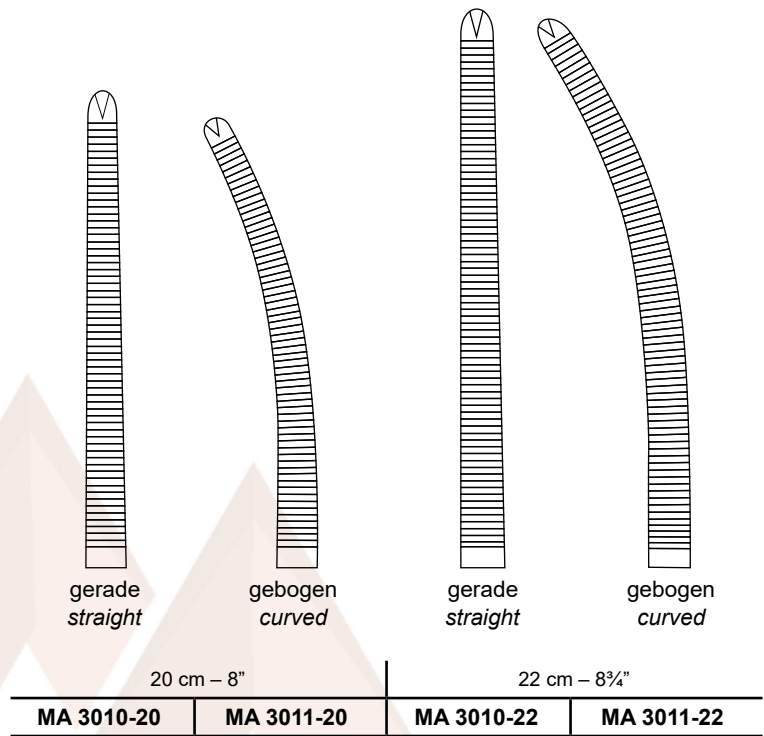

Arterienklemmen Hemostatic Forceps

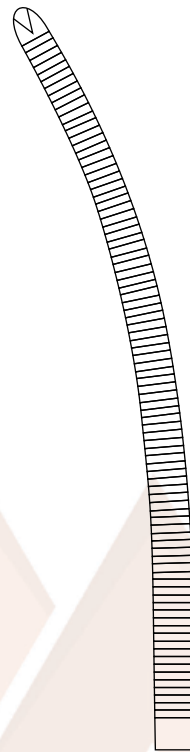

30 cm – 11¾"

MA 3010-30





MA 3011-30

M.ASHRAF
INSTRUMENTS

Arterienklemmen Hemostatic Forceps

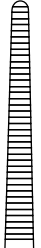

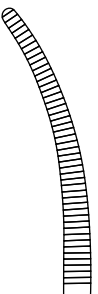

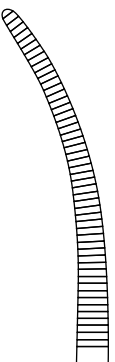

PEAN

					
gerade straight	gebogen curved	gerade straight	gebogen curved	gerade straight	gebogen curved
13 cm – 5"		14 cm – 5½"		16 cm – 6¼"	
MA 3020-13	MA 3021-13	MA 3020-14	MA 3021-14	MA 3020-16	MA 3021-16

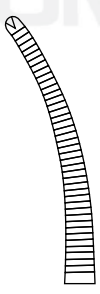

KOCHER

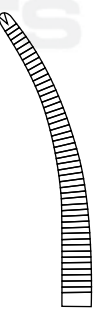

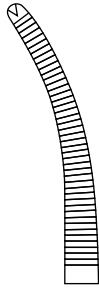
1 : 2 Zähne
1 : 2 teeth

					
gerade straight	gebogen curved	gerade straight	gebogen curved	gerade straight	gebogen curved
13 cm – 5"		14 cm – 5½"		16 cm – 6¼"	
MA 3030-13	MA 3031-13	MA 3030-14	MA 3031-14	MA 3030-16	MA 3031-16

Arterienklemmen Hemostatic Forceps

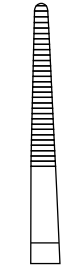

KELLY



gerade
straight

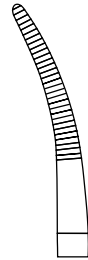

gebogen
curved

14,5 cm – 5¾"

MA 3050-14

MA 3051-14

M.ASHRAF
INSTRUMENTS



KELLY-RANKIN

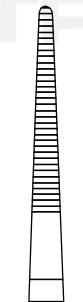

gerade
straight



gebogen
curved

16 cm – 6¼"

MA 3050-16

MA 3051-16

Arterienklemmen Hemostatic Forceps



CRILE

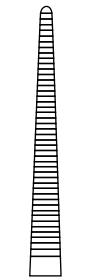

gerade
straight

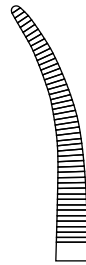

gebogen
curved

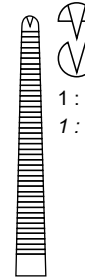

gerade
straight

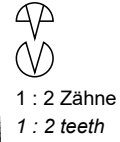

1 : 2 Zähne
1 : 2 teeth

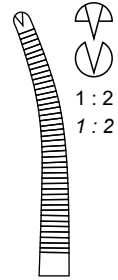

gebogen
curved

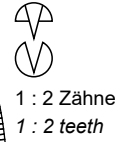

1 : 2 Zähne
1 : 2 teeth

14,5 cm – 5¾"

MA 3070-14

MA 3071-14

MA 3074-14

MA 3075-14



CRILE-RANKIN



gerade
straight



gebogen
curved

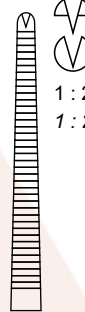

gerade
straight



1 : 2 Zähne
1 : 2 teeth

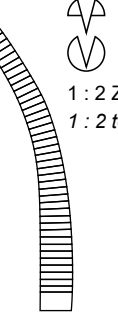

gebogen
curved

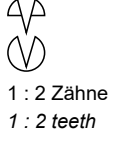

1 : 2 Zähne
1 : 2 teeth

16 cm – 6¼"

MA 3070-16

MA 3071-16

MA 3074-16

MA 3075-16



BABY-CRILE

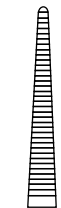

gerade
straight

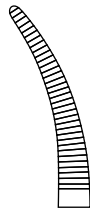

gebogen
curved

14,5 cm – 5¾"

MA 3072-14

MA 3073-14



BABY-CRILE



1 : 2 Zähne
1 : 2 teeth



gerade
straight

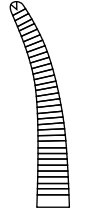

gebogen
curved

14,5 cm – 5¾"

MA 3076-14

MA 3077-14

Arterienklemmen Hemostatic Forceps



COLLER-CRILE

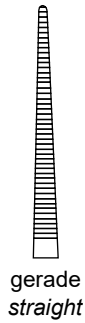

gerade
straight

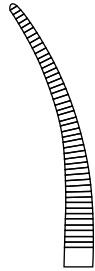

gebogen
curved



gerade
straight

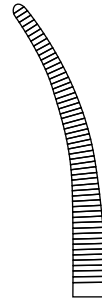

gebogen
curved

14 cm – 5½"

16 cm – 6¼"

MA 3078-14

MA 3079-14

MA 3078-16

MA 3079-16



COLLER-CRILE

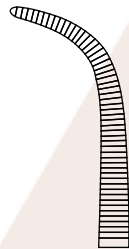

gebogen
curved

16 cm – 6¼"

MA 3979-36



LERICHE

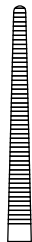

gerade
straight

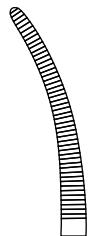

gebogen
curved

15 cm – 6"

MA 3080-15

MA 3081-15



LERICHE



1 : 2 Zähne
1 : 2 teeth

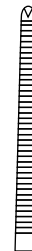

gerade
straight



gebogen
curved

15 cm – 6"

MA 3082-15

MA 3083-15

Arterienklemmen Hemostatic Forceps



PROVIDENCE



gerade
straight



gebogen
curved

14,5 cm – 5¾"

MA 3090-14 | **MA 3091-14**



Ligaturklemme
Ligature forceps



gerade, glatt
straight, smooth

9,5 cm – 3¾"

MA 3097-09

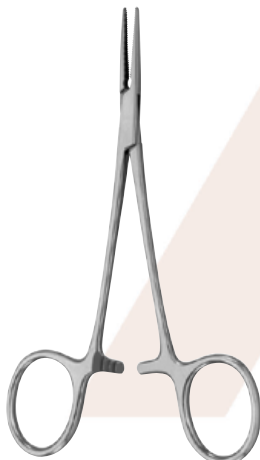

HALSTED-MOSQUITO



gerade
straight



gebogen
curved

12,5 cm – 5"

MA 3100-12 | **MA 3101-12**



HALSTED-MOSQUITO



1 : 2 Zähne
1 : 2 teeth



gerade
straight



gebogen
curved

12,5 cm – 5"

MA 3110-12 | **MA 3111-12**



HALSTED-MOSQUITO



gerade
straight



gebogen
curved

14 cm – 5½"

MA 3100-14 | **MA 3101-14**



HALSTED-MOSQUITO



1 : 2 Zähne
1 : 2 teeth



gerade
straight

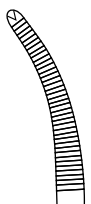

gebogen
curved

14 cm – 5½"

MA 3110-14 | **MA 3111-14**

Arterienklemmen Hemostatic Forceps



HALSTED-MOSQUITO



gerade
straight



gebogen
curved

18 cm – 7"

MA 3100-18

MA 3101-18

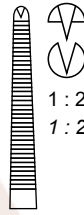

gerade
straight

1 : 2 Zähne
1 : 2 teeth



gebogen
curved

1 : 2 Zähne
1 : 2 teeth

18 cm – 7"

MA 3110-18

MA 3111-18



HALSTED-MOSQUITO



gerade
straight

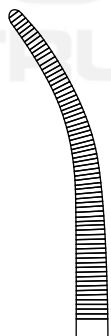

gebogen
curved

21 cm – 8¼"

MA 3100-21

MA 3101-21



gerade
straight

1 : 2 Zähne
1 : 2 teeth



gebogen
curved

1 : 2 Zähne
1 : 2 teeth

21 cm – 8¼"

MA 3110-21

MA 3111-21

Arterienklemmen Hemostatic Forceps



JACOBSON



gerade
straight



gebogen
curved

13 cm – 5"

MA 3114-13

MA 3115-13



MICRO-MOSQUITO



gerade
straight



gebogen
curved

10 cm – 4"

MA 3120-10

MA 3121-10



gerade
straight

1 : 2 Zähne
1 : 2 teeth

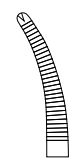

gebogen
curved

1 : 2 Zähne
1 : 2 teeth

10 cm – 4"

MA 3122-10

MA 3123-10

**M.ASHRAF
INSTRUMENTS**



MICRO-MOSQUITO

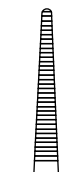

gerade
straight

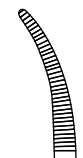

gebogen
curved

12,5 cm – 5"

MA 3120-12

MA 3121-12

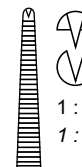

gerade
straight

1 : 2 Zähne
1 : 2 teeth

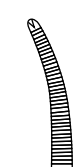

gebogen
curved

1 : 2 Zähne
1 : 2 teeth

12,5 cm – 5"

MA 3122-12

MA 3123-12

Arterienklemmen Hemostatic Forceps

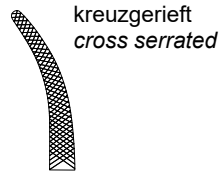

kreuzgerieft
cross serrated

gebogen
curved

12 cm – 4¾"

MA 3137-12



HARTMANN



gerade
straight



gebogen
curved

10 cm – 4"

MA 3140-10

MA 3141-10

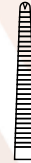

gerade
straight

1 : 2 Zähne
1 : 2 teeth



gebogen
curved

1 : 2 Zähne
1 : 2 teeth

10 cm – 4"

MA 3142-10

MA 3143-10

M.ASHRAF
INSTRUMENTS



CARREL



gerade
straight

10 cm – 4"

MA 3147-10



CHAPUT



gerade
straight

13 cm – 5"

MA 3148-13



2 : 3 Zähne
2 : 3 teeth



Arterienklemmen Hemostatic Forceps



TUFFIER



gerade
straight

13 cm – 5"

MA 3149-13



PENNINGTON



gerade
straight

15 cm – 6"

MA 3152-15



gebogen
curved

20 cm – 8"

MA 3152-20



PEAN

kurzfassende Maulteile
short gripping jaws



gerade
straight

14 cm – 5½"

MA 3153-14



gerade
straight

16 cm – 6¼"

MA 3153-16

Arterienklemmen Hemostatic Forceps



COLLIN



*gerade
straight*

15,5 cm – 6"

MA 3155-16

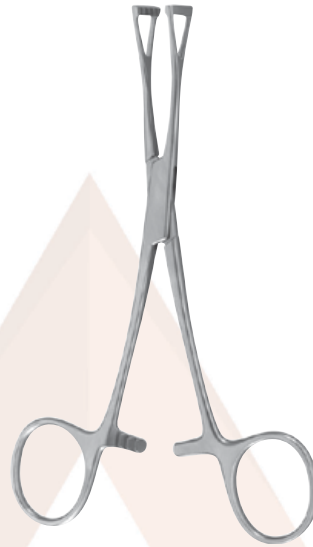

COLLIN



*gerade
straight*

14 cm – 5½"

MA 3156-14



COLLIN



*gerade
straight*

16,5 cm – 6½"

MA 3157-16



DUNHILL



*gebogen
curved*

13 cm – 5"

MA 3159-13

Arterienklemmen Hemostatic Forceps



CAIRNS



gerade
straight



gebogen
curved

15 cm – 6"

MA 3162-15

MA 3163-15



MOYNIHAN



seitlich gebogen
curved sideways

13,5 cm – 5¼"

MA 3164-01



MOYNIHAN



gebogen
curved

15 cm – 6"

MA 3164-02

Arterienklemmen Hemostatic Forceps

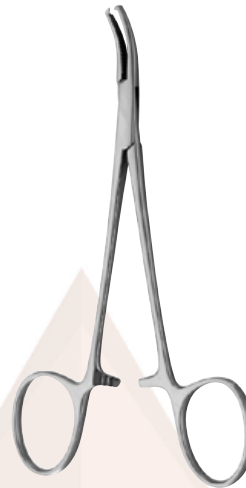

RAIMONDI







HOEN

M.ASHRAF
INSTRUMENTS

Arterienklemmen Hemostatic Forceps



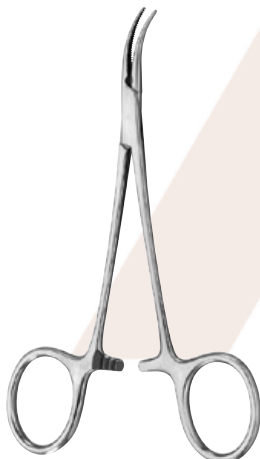

ROCHESTER-CARMALT

			
gerade straight	gebogen curved	gerade straight	gebogen curved
16 cm – 6¼"		20 cm – 8"	
MA 3170-16	MA 3171-16	MA 3170-20	MA 3171-20



MOSQUITO-DANDY

	
seitlich gebogen curved sideways	kreuzgerieft cross serrated
12 cm – 4¾"	
MA 3179-12	MA 3181-12

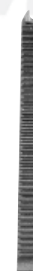

DANDY

	
seitlich gebogen curved sideways	1 : 2 Zähne 1 : 2 teeth
14 cm – 5½"	
MA 3182-14	MA 3183-14

Arterienklemmen Hemostatic Forceps



LOVELACE



15,5 cm – 6"

MA 3185-15



DIXON-LOVELACE

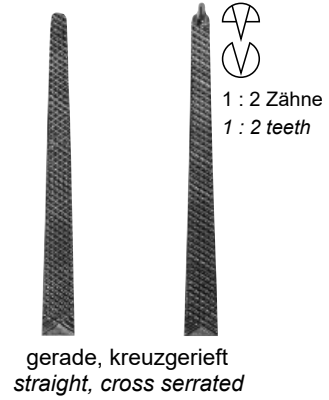

16 cm – 6 1/4"

MA 3186-16

MA 3187-16



BAINBRIDGE

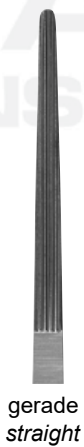

15 cm – 6"

MA 3190-15

MA 3191-15

18 cm – 7"

MA 3190-18

MA 3191-18

Arterienklemmen Hemostatic Forceps



FUCHSIG



gebogen
curved

19 cm – 7½"

MA 3198-19



ADSON



gerade
straight



gebogen
curved

18,5 cm – 7¼"

MA 3200-18

MA 3201-18



NISSEN



gebogen
curved

18,5 cm – 7¼"

MA 3204-18



stark gebogen
strongly curved

22 cm – 8¾"

MA 3204-22



BABY-ADSON



leicht gebogen
slightly curved

14 cm – 5½"

MA 3205-14



stark gebogen
strongly curved

18 cm – 7"

MA 3205-18

Arterienklemmen Hemostatic Forceps



gerade
straight



gebogen
curved

20 cm – 8"

MA 3240-20

MA 3241-20



gerade
straight



gebogen
curved

22 cm – 8¾"

MA 3240-22

MA 3241-22



kreuzgerieft
cross serrated

BENGOLEA



gerade
straight



gebogen
curved

24 cm – 9½"

MA 3240-24

MA 3241-24



gerade
straight



gebogen
curved

26 cm – 10¼"

MA 3240-26

MA 3241-26

M.ASHRAF
INSTRUMENTS

Arterienklemmen Hemostatic Forceps



BIRKETT

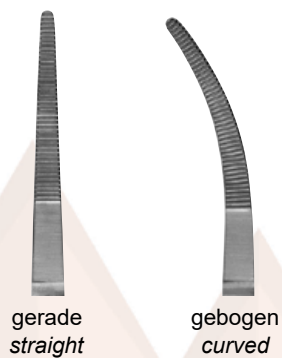

gerade
straight

gebogen
curved

19 cm – 7½"

MA 3210-19	MA 3211-19
-------------------	-------------------



ROBERTS

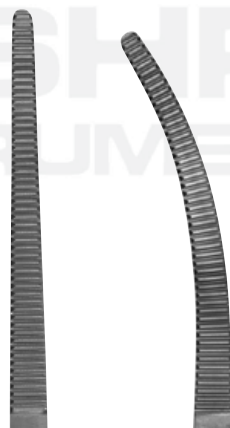

gerade
straight

gebogen
curved

22 cm – 8¾"

MA 3250-22	MA 3251-22
-------------------	-------------------

Arterienklemmen Hemostatic Forceps

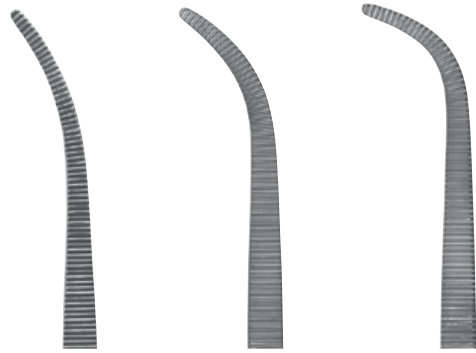

gebogen
curved

leicht gebogen
slightly curved

stark gebogen
strongly curved

19 cm – 7½"

MA 3253-41	MA 3253-42	MA 3253-43
-------------------	-------------------	-------------------



gebogen
curved

leicht gebogen
slightly curved

stark gebogen
strongly curved

22 cm – 8¾"

MA 3253-61	MA 3253-62	MA 3253-63
-------------------	-------------------	-------------------

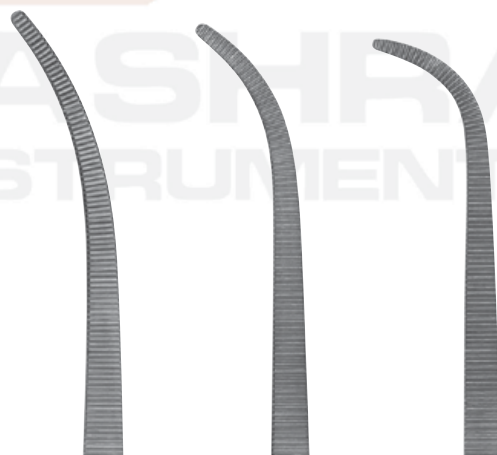

gebogen
curved

leicht gebogen
slightly curved

stark gebogen
strongly curved

24 cm – 9½"

MA 3253-71	MA 3253-72	MA 3253-73
-------------------	-------------------	-------------------



KELLY

Arterienklemmen Hemostatic Forceps



SAROT



gerade
straight



gebogen
curved

24 cm – 9½"

MA 3270-24

MA 3271-24

M.ASHRAF INSTRUMENTS

Arterienklemmen Hemostatic Forceps



CRAFOORD

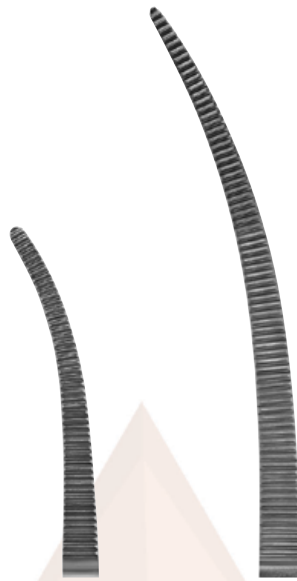

gebogen
curved

18 cm – 7"

24 cm – 9½"

MA 3275-18

MA 3275-24



Ligaturklemme
Ligature forceps

KANTROWITZ

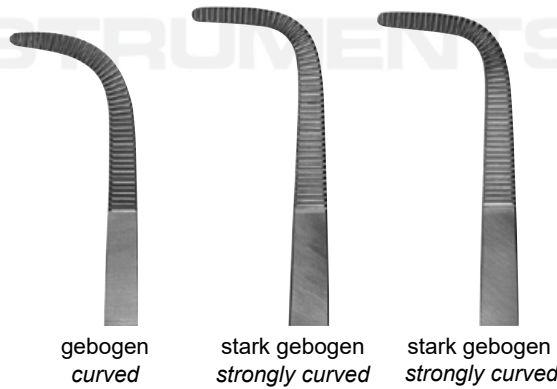

gebogen
curved

stark gebogen
strongly curved

stark gebogen
strongly curved

19 cm – 7½"

24 cm – 9½"

26,5 cm – 10½"

MA 3279-19

MA 3279-24

MA 3279-26

Ligaturklemmen Ligature Forceps



JOHNS-HOPKINS

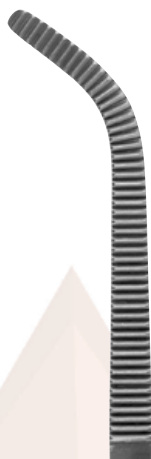

gebogen
curved

20 cm – 8"

MA 3285-20



RUMEL



gebogen
curved



gebogen
curved



gebogen
curved



gebogen
curved

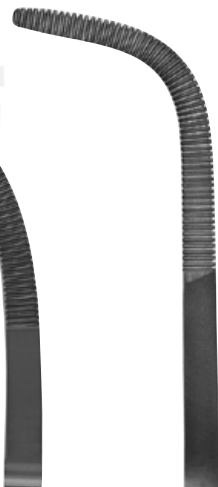

gebogen
curved

23 cm – 9"

MA 3280-01

MA 3280-02

MA 3280-03

MA 3280-04

MA 3280-05



ZENKER



gerade
straight



leicht gebogen
slightly curved



stark gebogen
strongly curved

29,5 cm – 11½"

MA 3286-00	MA 3286-01	MA 3286-02
------------	------------	------------

M.ASHRAF
INSTRUMENTS



BABY-OVERHOLT



gebogen
curved

13,5 cm – 5¼"

MA 3289-14

Ligaturklemmen Ligature Forceps



S-gebogen
S-curved

OVERHOLT-SLIM



1:2

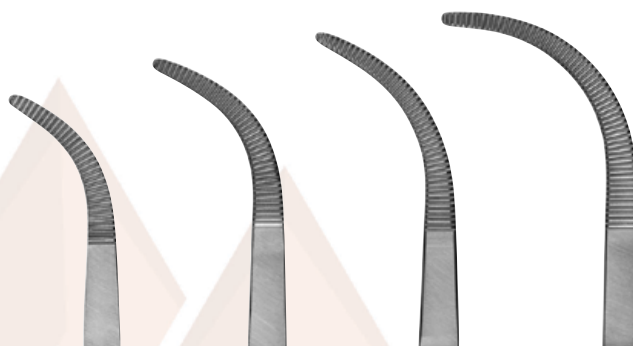

gebogen
curved

18,5 cm – 7¼"	20,5 cm – 8"	21 cm – 8¼"	21,5 cm – 8½"
MA 3290-21	MA 3290-22	MA 3290-23	MA 3290-24



S-gebogen
S-curved

OVERHOLT-S



1:2



gebogen
curved

18,5 cm – 7¼"	20,5 cm – 8"	21 cm – 8¼"	21,5 cm – 8½"	24 cm – 9½"
MA 3290-01	MA 3290-02	MA 3290-03	MA 3290-04	MA 3290-05

Ligaturklemmen Ligature Forceps

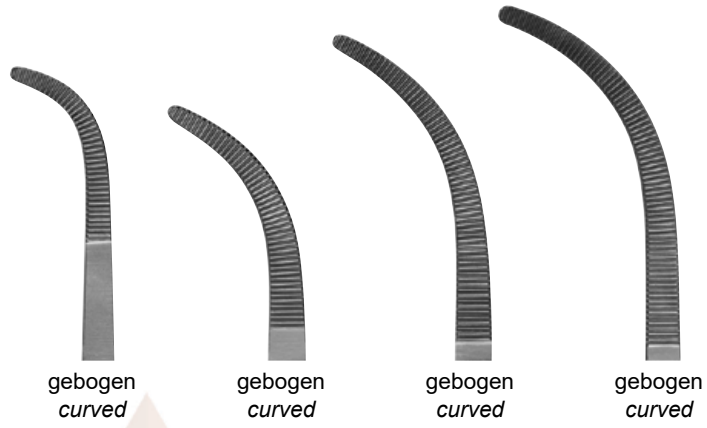

21 cm – 8¼"

MA 3291-21	MA 3292-21	MA 3293-21	MA 3294-21
-------------------	-------------------	-------------------	-------------------



OVERHOLT-GEISSENDÖRFER

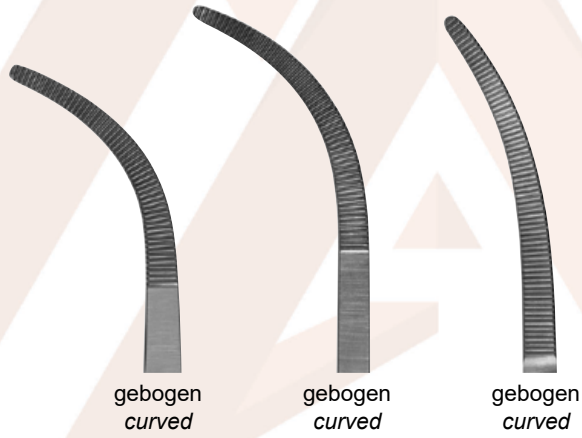

21 cm – 8¼"

MA 3295-21	MA 3296-21	MA 3297-21
-------------------	-------------------	-------------------

M.ASHRAF
INSTRUMENTS

Ligaturklemmen Ligature Forceps



OVERHOLT-GEISSENDÖRFER

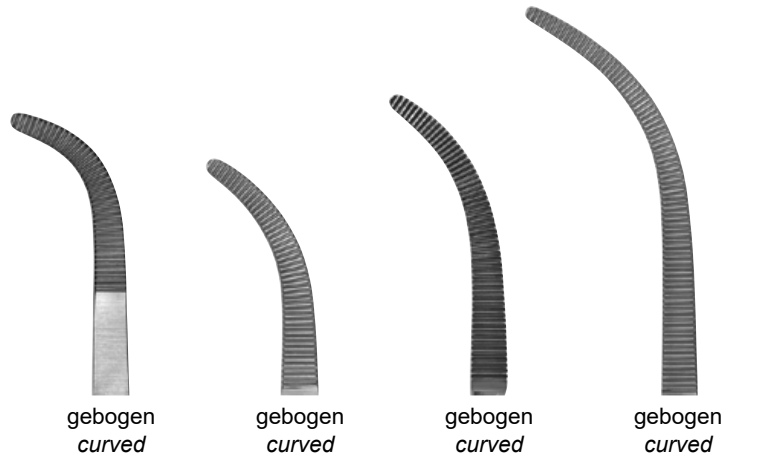

27 cm – 10½"

MA 3291-27	MA 3292-27	MA 3293-27	MA 3294-27
------------	------------	------------	------------

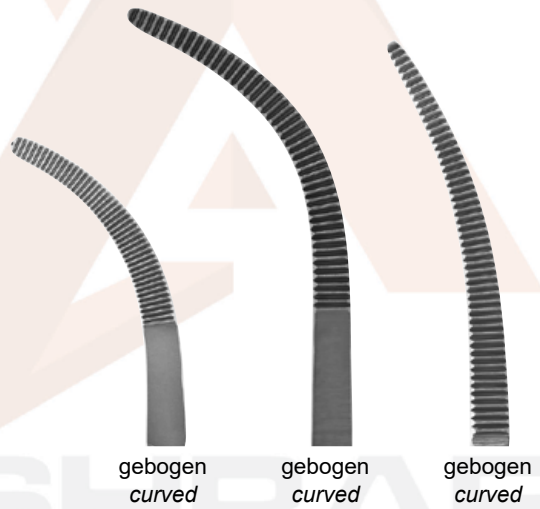

27 cm – 10½"

MA 3295-27	MA 3296-27	MA 3297-27
------------	------------	------------



OVERHOLT-MIXTER

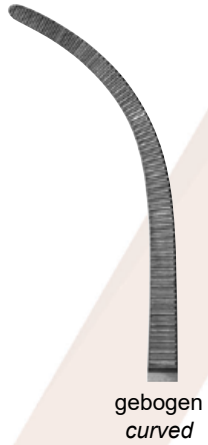

gebogen
curved

21 cm – 8¼"

MA 3298-21



HEISS



gerade
straight



leicht gebogen
slightly curved



stark gebogen
strongly curved

20 cm – 8"

MA 3301-20

MA 3302-20

MA 3303-20



1 : 2 Zähne
1 : 2 teeth



gerade
straight



gebogen
curved

20 cm – 8"

MA 3305-20

MA 3306-20

Ligaturklemmen Ligature Forceps

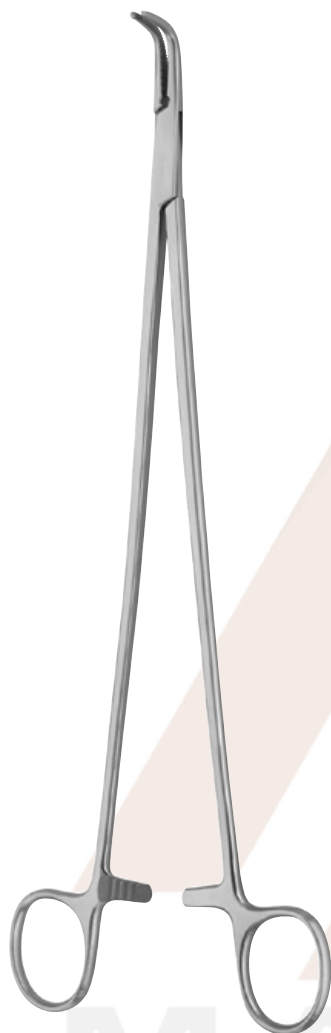

MEEKER



gebogen
curved

27 cm – 10½"

MA 3308-27



LOWER

Gallenkanalklemme
Gall duct forceps



gebogen
curved

18 cm – 7"

MA 3325-18

Ligaturklemmen Ligature Forceps

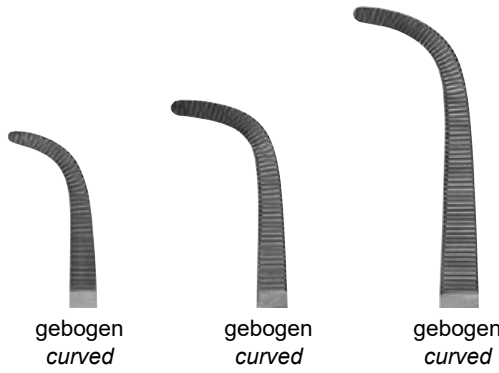

13 cm – 5"	18 cm – 7"	20 cm – 8"
MA 3326-13	MA 3326-18	MA 3326-20



GEMINI



23 cm – 9"	25 cm – 10"	27 cm – 10½"
MA 3326-23	MA 3326-25	MA 3326-27

M.ASHRAF
INSTRUMENTS

Ligaturklemmen Ligature Forceps



MINI-GEMINI

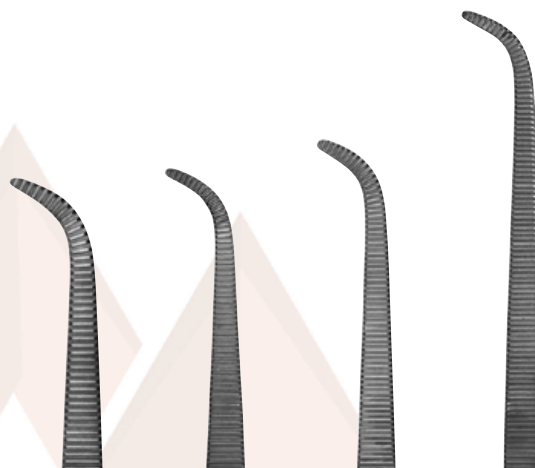

gebogen
curved

18 cm – 7"	22 cm – 8¾"	25 cm – 10"	28 cm – 11"
MA 3327-18	MA 3327-22	MA 3327-25	MA 3327-28



BABY-MIXTER



gebogen
curved

14 cm – 5½"	14 cm – 5½"	18 cm – 7"
MA 3328-01	MA 3328-14	MA 3328-18



18 cm – 7"
MA 3329-01



15 cm – 6"	19 cm – 7½"
MA 3330-15	MA 3330-19

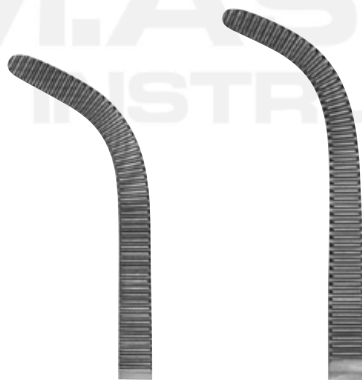

gebogen
curved

15,5 cm – 6"	19 cm – 7½"
MA 3335-15	MA 3335-19

M.ASHRAF
INSTRUMENTS

Ligaturklemmen Ligature Forceps



<i>gebogen curved</i>	
18 cm – 7"	23 cm – 9"
MA 3336-18	MA 3336-23



<i>gebogen curved</i>		
<i>gebogen curved</i>	<i>gebogen curved</i>	<i>gebogen curved</i>
22 cm – 8¾"	25 cm – 10"	28 cm – 11"
MA 3341-22	MA 3342-25	MA 3343-28



MIXTER



gebogen
curved

22 cm – 8¾"

MA 3350-22



WICKSTROEM



gebogen
curved

20 cm – 8"

MA 3351-20



FINOCCHIETTO



gebogen
curved

24 cm – 9½"

MA 3352-24

Ligaturklemmen Ligature Forceps

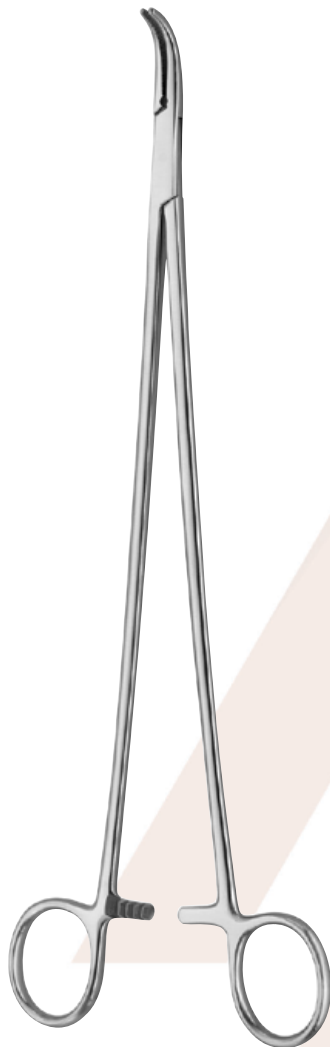

LAWRENCE



gebogen
curved

27,5 cm – 10¾"

MA 3355-27

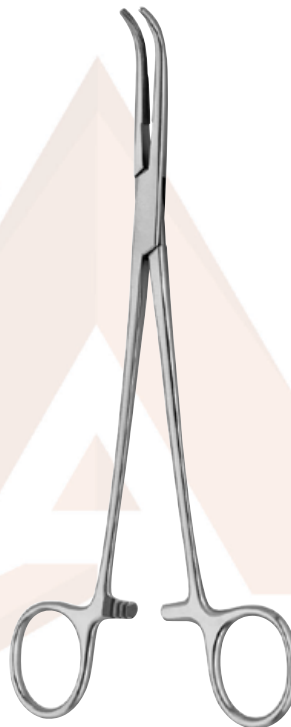

LAHEY



gebogen
curved

19 cm – 7½"

MA 3361-19



23 cm – 9"

MA 3361-23

M.ASHRAF
INSTRUMENTS

Ligaturklemmen Ligature Forceps



gerade
straight



gerade
straight



gerade
straight



gerade
straight



gerade
straight

13 cm – 5"	14 cm – 5½"	15 cm – 6"	18 cm – 7"	20 cm – 8"
MA 3380-13	MA 3380-14	MA 3380-15	MA 3380-18	MA 3380-20



SPENCER-WELLS



gebogen
curved



gebogen
curved



gebogen
curved



gebogen
curved



gebogen
curved

13 cm – 5"	14 cm – 5½"	15 cm – 6"	18 cm – 7"	20 cm – 8"
MA 3381-13	MA 3381-14	MA 3381-15	MA 3381-18	MA 3381-20

M.ASHRAF
INSTRUMENTS

Klemmzangen Clamp Forceps

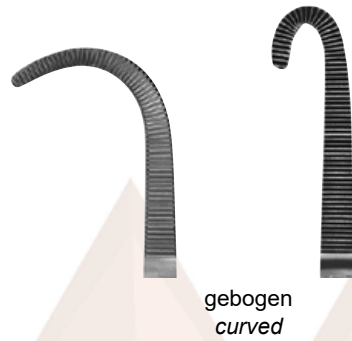

19 cm – 7½"

MA 3387-01	MA 3387-02
-------------------	-------------------



21 cm – 8¼"

MA 3392-21



1 : 2 Zähne
1 : 2 teeth



20,5 cm – 8"

25 cm – 10"

MA 3394-20	MA 3394-25
-------------------	-------------------



FAURE



gebogen
curved

25 cm – 10"

MA 3433-45

M.ASHRAF
INSTRUMENTS

Peritoneumklemmen Peritoneal Forceps



WERTHEIM



gebogen
curved

18 cm – 7"

MA 3438-18



BABY-MIKULICZ

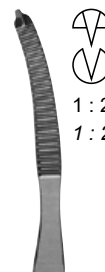

gebogen
curved

14 cm – 5½"

MA 3492-14



1 : 2 Zähne
1 : 2 teeth



BABY-MIKULICZ



gebogen
curved

18,5 cm – 7¼"

MA 3499-18



1 : 2 Zähne
1 : 2 teeth



MIKULICZ



18 cm – 7"

MA 3500-18



gebogen
curved

20 cm – 8"

MA 3500-20



1 : 2 Zähne
1 : 2 teeth

Peritoneumklemmen Peritoneal Forceps



MIKULICZ



1 : 2 Zähne
1 : 2 teeth

gebogen
curved

20 cm – 8"

MA 3501-20

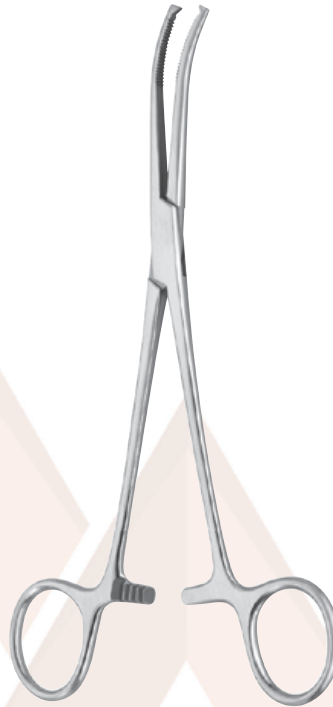

MIKULICZ



1 : 2 Zähne
1 : 2 teeth

seitlich gebogen
curved sideways

18,5 cm – 7 1/4"

MA 3502-18



MIKULICZ



1 : 2 Zähne
1 : 2 teeth

gebogen
curved

18 cm – 7"

MA 3504-18



MIKULICZ



1 : 2 Zähne
1 : 2 teeth



gebogen
curved

20 cm – 8"

MA 3505-20



MA 3506-20

Peritoneumklemmen Peritoneal Forceps



FAURE



1 : 2 Zähne
1 : 2 teeth

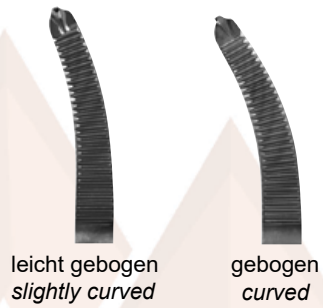

leicht gebogen
slightly curved

gebogen
curved

20 cm – 8"

MA 3511-20

MA 3512-20

M.ASHRAF
INSTRUMENTS

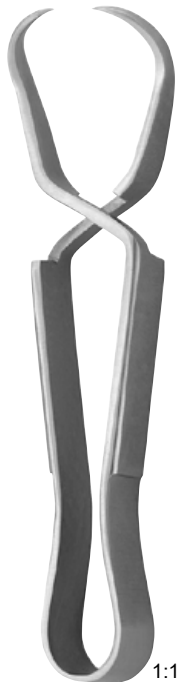

SCHÄDEL 1:1

gebogen
curved

9 cm – 3½"

MA 3550-09



JONES 1:1

gebogen
curved

6 cm – 2½"

MA 3552-05

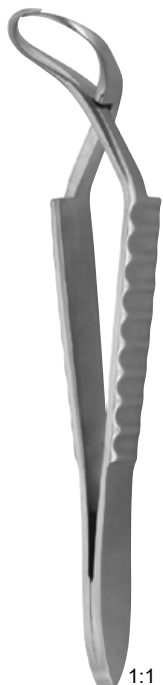

JONES 1:1

gebogen
curved

9 cm – 3½"

MA 3552-09



ENGLISHES MODELL
ENGLISH PATTERN 1:1

gebogen
curved

9 cm – 3½"

MA 3553-09

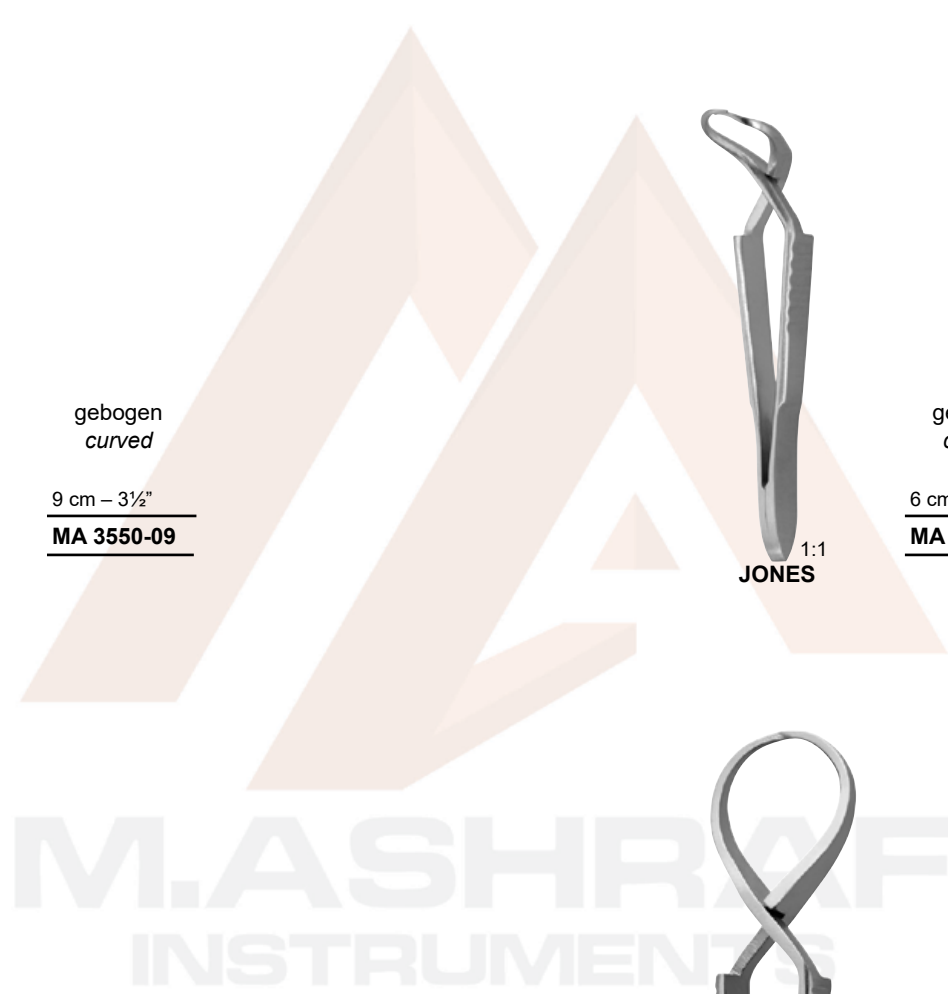

Tuchklemmen Towel Forceps



BACKHAUS

9 cm – 3½"	MA 3600-09
11 cm – 4¼"	MA 3600-11
13 cm – 5"	MA 3600-13
15 cm – 6"	MA 3600-15

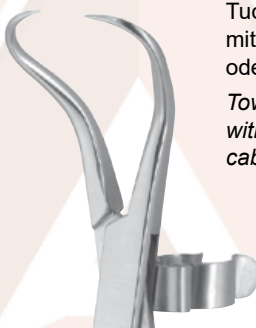
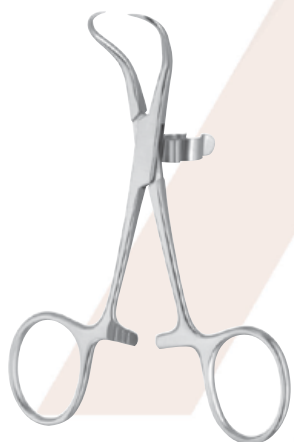

Tuchklemme
mit Schlauch-
oder Kabelhalter
*Towel forceps
with clip for tubing or
cable*

11 cm – 4¼"	MA 3602-11
13 cm – 5"	MA 3602-13



PEERS-BERTRAM



14,5 cm – 5¾"	MA 3604-14
---------------	-------------------



TOHOKU

10 cm – 4"	MA 3605-10
13 cm – 5"	MA 3605-13



Tuchklemme
für Papiertücher
*Towel forceps
for paper tissues*

11 cm – 4¼"	MA 3617-11
14 cm – 5½"	MA 3617-13



M.ASHRAF
INSTRUMENTS



LORNA

10 cm – 4"	MA 3618-10
13 cm – 5"	MA 3618-13



Tuchklemmen Towel Forceps



BERNHARD





16,5 cm – 6½"
MA 3620-16

M.ASHRAF
INSTRUMENTS



LANE

		
13 cm – 5"	15,5 cm – 6"	20 cm – 8"
MA 3622-13	MA 3622-15	MA 3622-20

Schlauchklemmen Tubing Forceps



15 cm – 6"	18 cm – 7"	20 cm – 8"
MA 3680-15	MA 3680-18	MA 3680-20

M.ASHRAF
INSTRUMENTS



14,5 cm – 5¾"
MA 3682-14



glatt
smooth

16,5 cm – 6½"	18 cm – 7"
MA 3684-16	MA 3684-18

Schlauchklemmen Tubing Forceps



Schlauchklemme
mit Schutzbügel
*Tubing forceps with
safety guard*

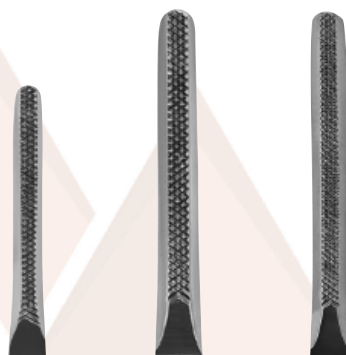

15 cm – 6"	18 cm – 7"	20 cm – 8"
MA 3686-15	MA 3686-18	MA 3686-20



1:1
HOFFMANN

max. Schlauch-Durchmesser- max. tubing diameter	
8 mm	MA 3692-13
10 mm	MA 3692-17
12 mm	MA 3692-20
15 mm	MA 3692-25
18 mm	MA 3692-30
25 mm	MA 3692-40

Kornzangen Dressing Forceps



ULRICH



gerade
straight



gebogen
curved



gerade
straight



gebogen
curved



gerade
straight



gebogen
curved

22 cm – 8¾"

25 cm – 10"

27 cm – 10½"

MA 3800-22

MA 3801-22

MA 3800-25

MA 3801-25

MA 3800-27

MA 3801-27



LISTER

Sinusklemme
Sinus forceps



gerade
straight



gerade
straight



gerade
straight

12,5 cm – 5"

16 cm – 6¼"

18 cm – 7"

MA 3810-12

MA 3810-16

MA 3810-18

Korn-(Polypen) Zange
Dressing and polypus forceps



BRYANT



gebogen
curved

13 cm – 5"

MA 3812-13

Kornzangen Dressing Forceps



GROSS-MAIER



mit Sperre
with ratchet

ohne Sperre
without ratchet

gerade-
straight

gebogen-
curved

gerade-
straight

gebogen-
curved

20 cm – 8"

20 cm – 8"

MA 3860-20

MA 3861-20

MA 3862-20

MA 3863-20



GROSS-MAIER

1:3



mit Sperre
with ratchet

ohne Sperre
without ratchet

gerade-
straight

gebogen-
curved

gerade-
straight

gebogen-
curved

25 cm – 10"

25 cm – 10"

MA 3860-25

MA 3861-25

MA 3862-25

MA 3863-25

Kornzangen Dressing Forceps

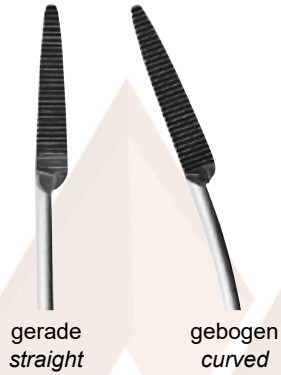

25 cm – 10"

MA 3872-25	MA 3873-25
-------------------	-------------------



28 cm – 11"

MA 3874-28	MA 3875-28
-------------------	-------------------

Tupferzangen Cotton Swab Forceps



COLLIN

1:3



gerade
straight

25 cm – 10"

MA 3887-25



CHERON

1:3



gebogen
curved

25 cm – 10"

MA 3888-25



EMMET



gerade
straight

21 cm – 8¼"

MA 3889-21



BOZEMANN

1:3



gerade
straight

26 cm – 10¼"

MA 3890-26

Tupferzangen Cotton Swab Forceps

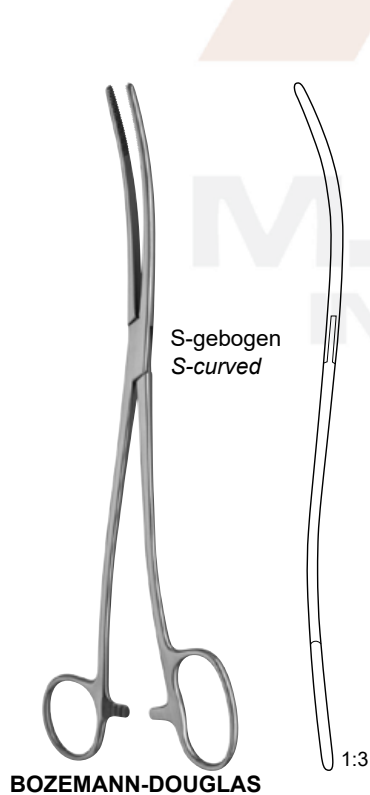
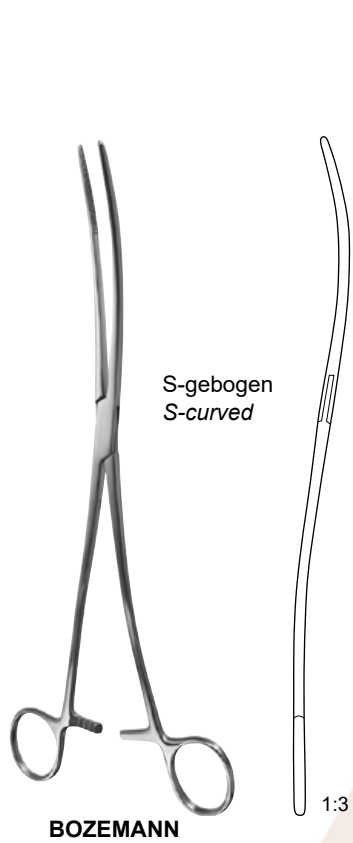

Schwammzangen Sponge Holding Forceps



FÖRSTER-BALLENGER

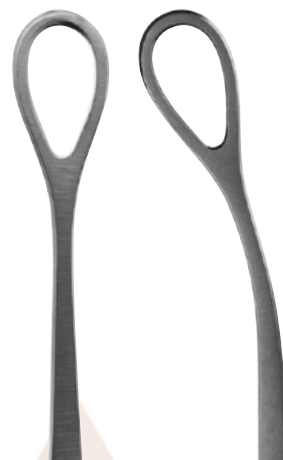

gerade, glatt
straight, smooth

gebogen, glatt
curved, smooth

18 cm – 7"	MA 3900-18	MA 3901-18
25 cm – 10"	MA 3900-25	MA 3901-25



FÖRSTER-BALLENGER



gerade, gerieft
straight, serrated

gebogen, gerieft
curved, serrated

18 cm – 7"	MA 3910-18	MA 3911-18
25 cm – 10"	MA 3910-25	MA 3911-25

Schwammzangen Sponge Holding Forceps



RAMPLAY

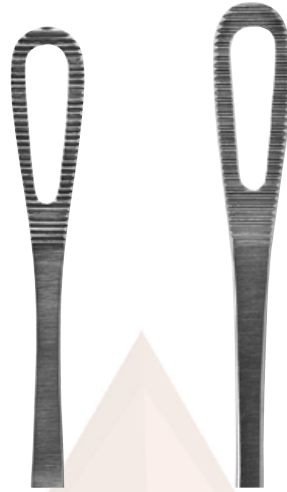

gerade
straight

18 cm – 7"

MA 3896-18

25 cm – 10"

MA 3896-25



COLLIN

Zungenzange
Tongue holding forceps



16 cm – 6¼"

MA 8450-16

Bulldogklemmen Bulldog Clamps

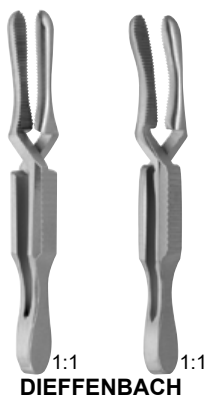

DIEFFENBACH

gerade
straight

gebogen
curved

3,5 cm – 1½"	MA 3144-03	MA 3145-03
5 cm – 2"	MA 3144-05	MA 3145-05



DIEFFENBACH

gerade
straight

gebogen
curved

6 cm – 2½"	MA 3144-06	MA 3145-06
------------	-------------------	-------------------



JOHNS-HOPKINS

gerade
straight

gebogen
curved

3,8 cm – 1½"	MA 3146-11	MA 3146-01
4,8 cm – 2"	MA 3146-12	MA 3146-02
5,7 cm – 2¼"	MA 3146-13	MA 3146-03
6,3 cm – 2½"	MA 3146-14	MA 3146-04
7 cm – 2¾"	MA 3146-15	MA 3146-05
7,5 cm – 3"	MA 3146-16	MA 3146-06
9 cm – 3½"	MA 3146-17	MA 3146-07

Bulldogklemmen Bulldog Clamps

Mikro-Clips
Micro clips



gerade
straight

2,7 cm – 1¼"

MA 3930-01



SCHWARTZ

leicht gebogen
slightly curved

2,7 cm – 1¼"

MA 3930-02



stark gebogen
strongly curved

2,5 cm – 1"

MA 3930-03



Anlegezange
für SCHWARTZ Mikro-
Clips *Applying forceps for
SCHWARTZ micro clips*

gebogen
curved

19 cm – 7½"

MA 3930-80

SCHWARTZ

M.ASHRAF
INSTRUMENTS



1:1
DE BAKEY-HESS

gewinkelt
angled

4,5 cm – 1¾"

MA 3936-20



1:1
DE BAKEY-HESS

gewinkelt
angled

5,5 cm – 2¼"

MA 3936-30



Bulldogklemmen Bulldog Clamps



1:1

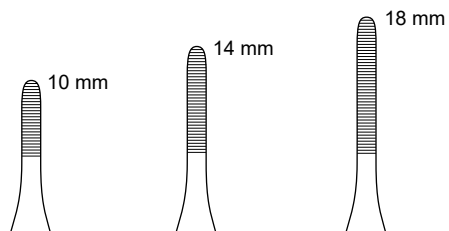

3 cm – 1¼"	3,5 cm – 1½"	4 cm – 1½"
MA 3932-00	MA 3932-04	MA 3932-08



1:1

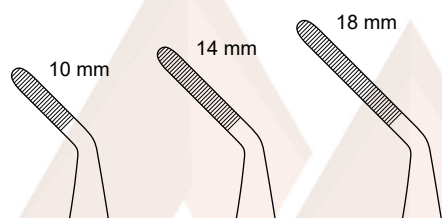

3 cm – 1¼"	3,5 cm – 1½"	4 cm – 1½"
MA 3932-10	MA 3932-14	MA 3932-18



1:1

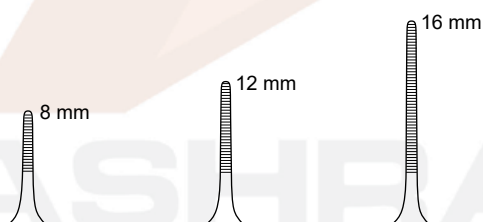

4,9 cm – 2"	5,3 cm – 2"	5,6 cm – 2¼"
MA 3934-08	MA 3934-12	MA 3934-16

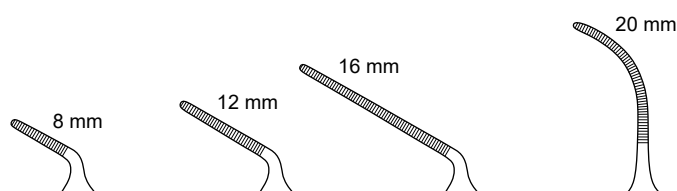

4,3 cm – 1½"	4,5 cm – 1½"	5,6 cm – 2¼"	5,4 cm – 2"
MA 3935-08	MA 3935-12	MA 3935-16	MA 3935-21

Bulldogklemmen Bulldog Clamps



1:1

DIETRICH



DE BAKEY Zahnung
DE BAKEY Serration

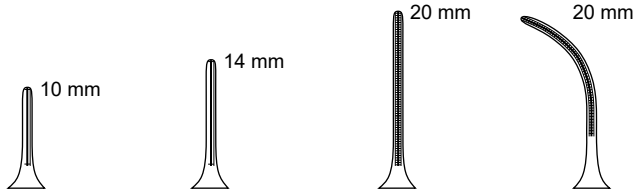

4,7 cm – 2"	5,1 cm – 2"	5,7 cm – 2¼"	5,4 cm – 2"
MA 3934-60	MA 3934-64	MA 3934-70	MA 3934-71

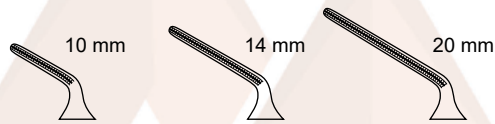

4,4 cm – 1½"	4,6 cm – 1½"	4,9 cm – 2"
MA 3935-60	MA 3935-64	MA 3935-70

M.ASHRAF
INSTRUMENTS



M.ASHRAF
INSTRUMENTS



FIVE



Retraktoren Retractors

Feine Wundhäkchen	<i>Fine Wound Retractors</i>	RE 1 - 2
Wund- und Trachealhäkchen	<i>Wound and Trachea Retractors</i>	RE 3 - 6
Wundhaken	<i>Retractors</i>	RE 7 - 29
Spatel	<i>Spatulas</i>	RE 30
Wundspreizer	<i>Self-retaining Retractors</i>	RE 31 - 47, RE 49
Spezialwundspreizer	<i>Special Retractors</i>	RE 48
Bauchdeckenhalter	<i>Abdominal Retractors</i>	RE 50 - 64

Feine Wundhäkchen Fine Wound Retractors

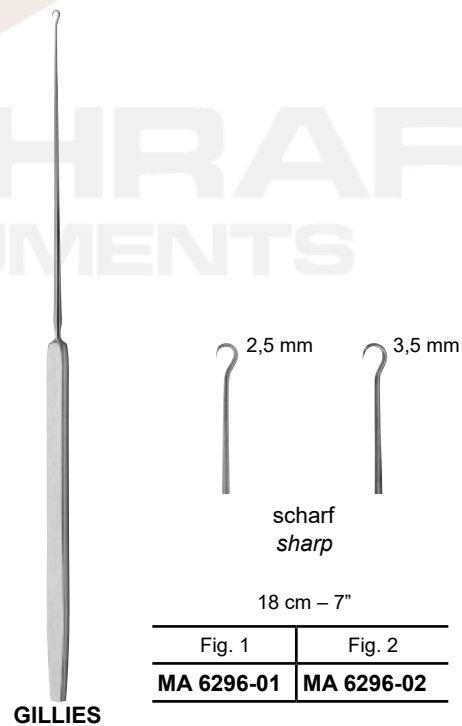
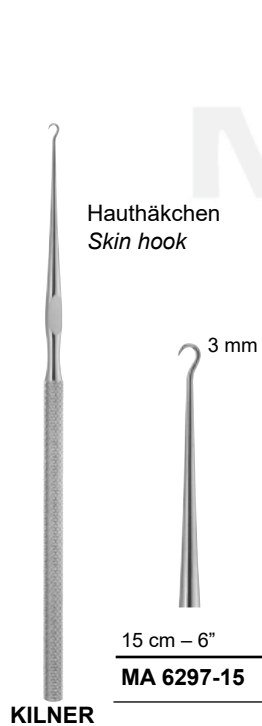
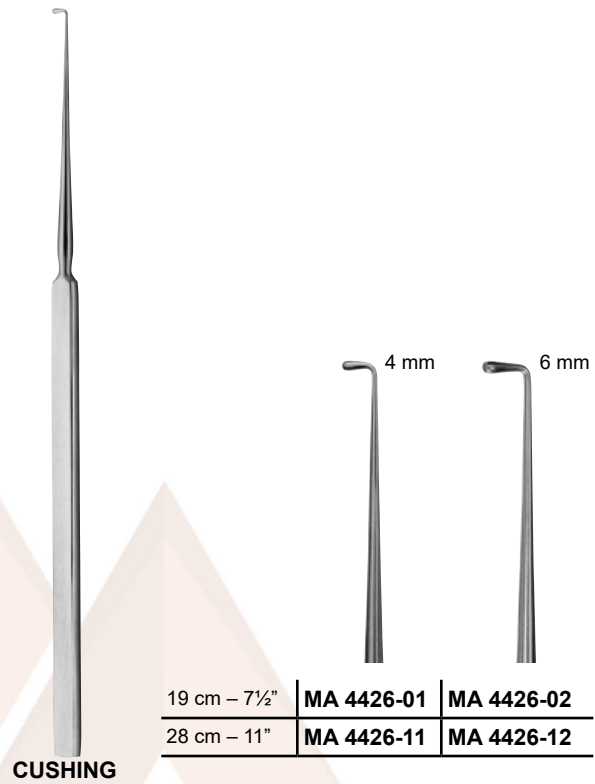
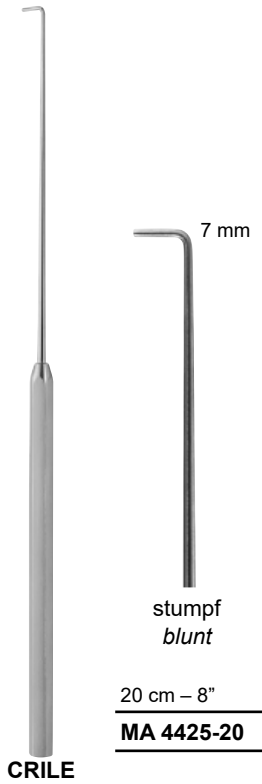

M.ASHRAF
INSTRUMENTS

Feine Wundhäkchen Fine Wound Retractors

Hauthäkchen
Skin hook

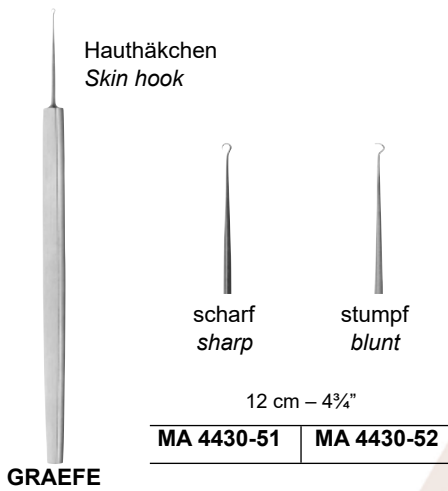

GRAEFE

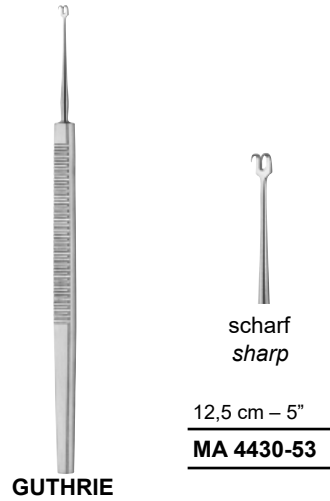

GUTHRIE

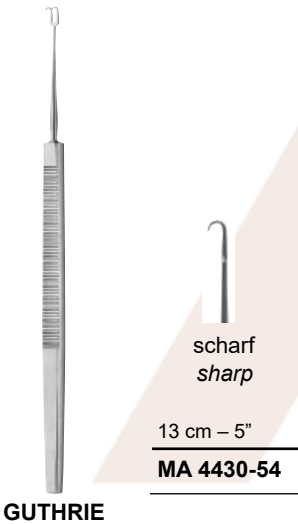

GUTHRIE

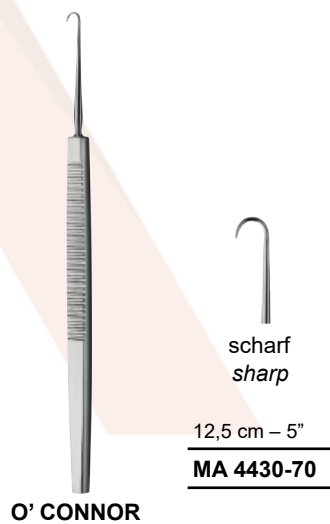

O'CONNOR

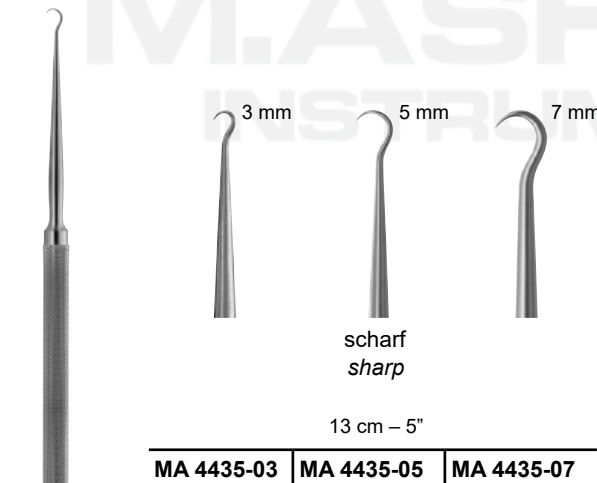

KLEINERT-KUTZ

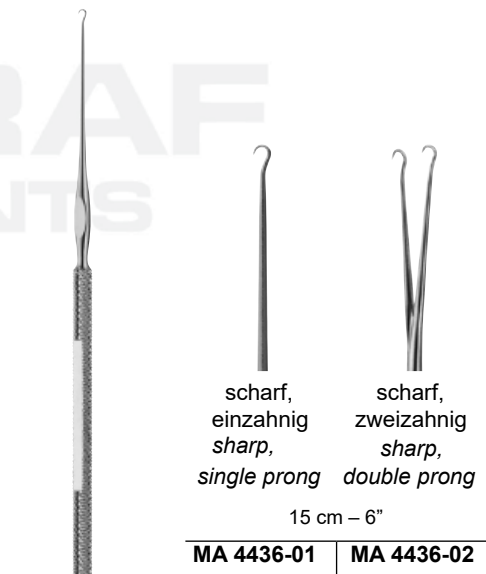





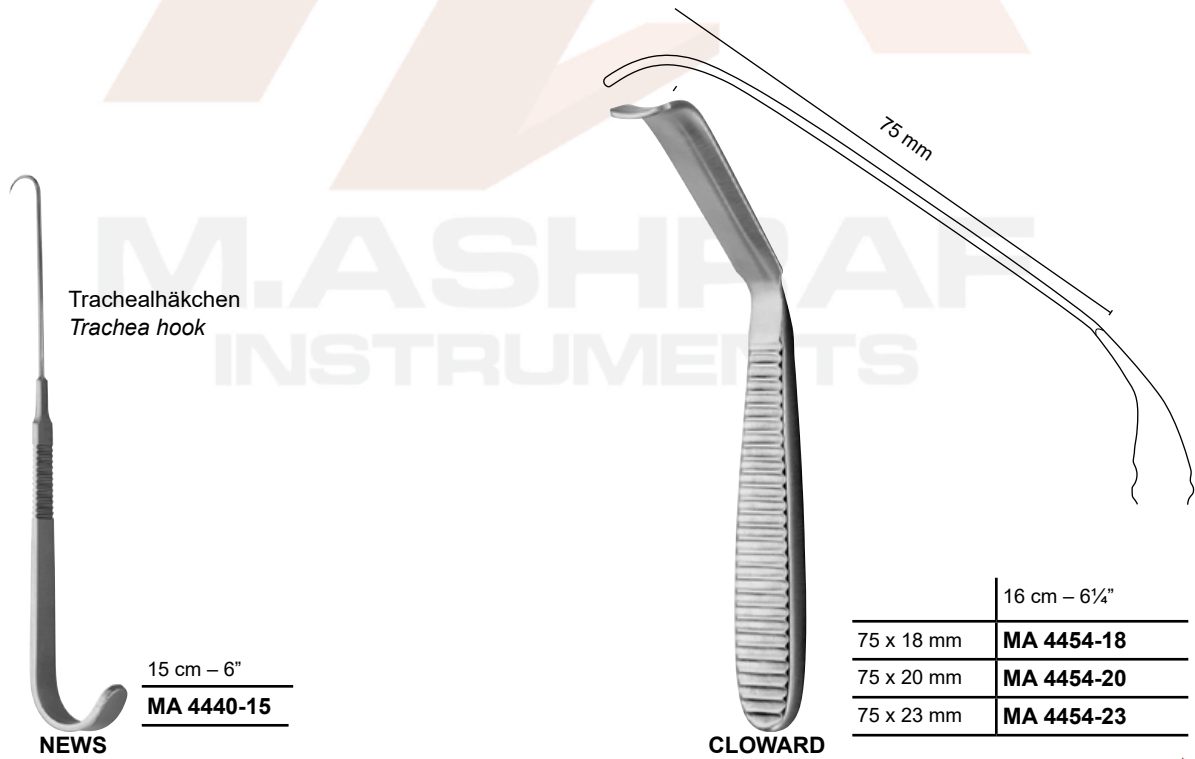
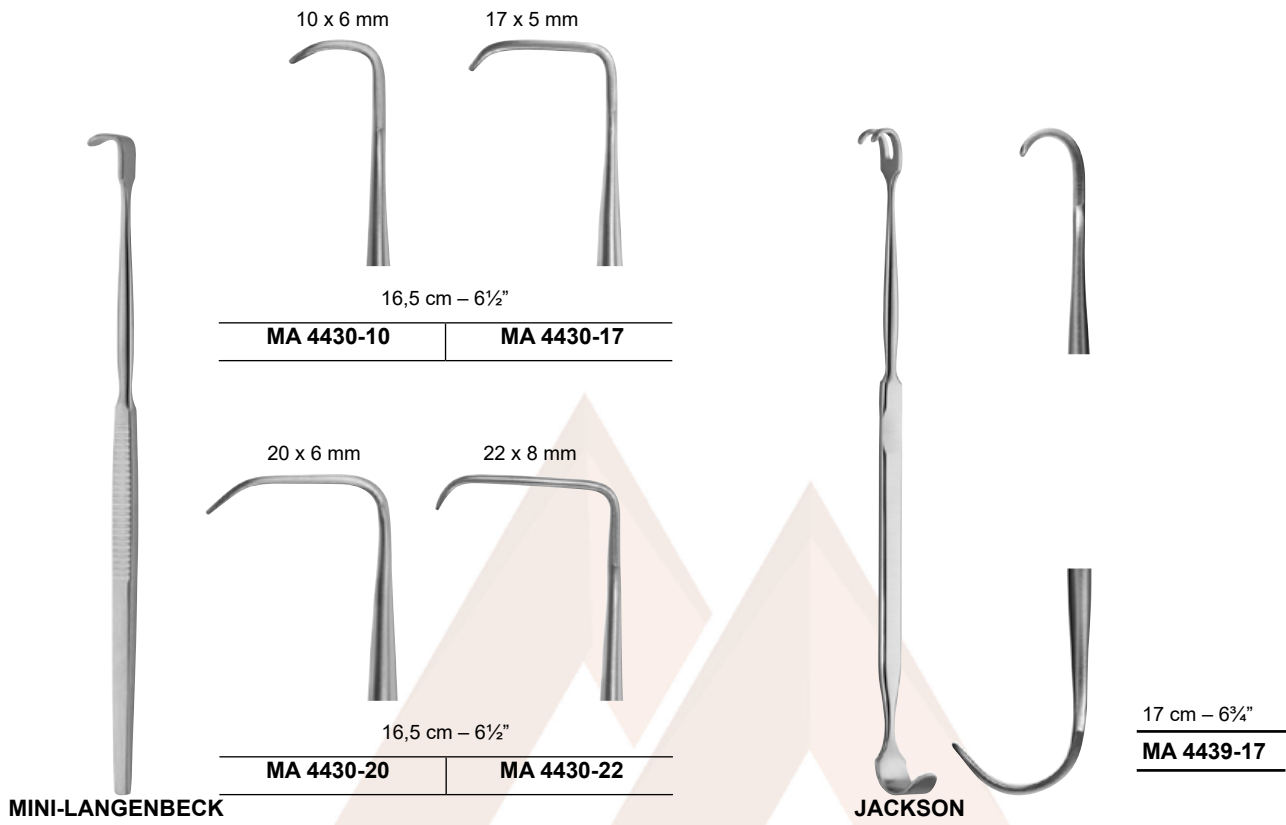













BARSKY

Wund- und Trachealhäkchen Wound and Trachea Retractors



Wund- und Trachealhäkchen Wound and Trachea Retractors

 <p>Standard Standard</p>				
	scharf sharp			
	16,5 cm – 6½"			
	MA 4460-01	MA 4460-02	MA 4460-03	MA 4460-04
				
	stumpf blunt			
	16,5 cm – 6½"			
	MA 4461-01	MA 4461-02	MA 4461-03	MA 4461-04
 <p>fein delicate</p>				
	scharf sharp			
	16 cm – 6¼"			
	MA 4462-01	MA 4462-02	MA 4462-03	MA 4462-04
				
	stumpf blunt			
	16 cm – 6¼"			
	MA 4463-01	MA 4463-02	MA 4463-03	MA 4463-04

Wund- und Trachealhäkchen Wound and Trachea Retractors



scharf
sharp

15,5 cm – 6"

MA 4464-01	MA 4464-02	MA 4464-03	MA 4464-04
------------	------------	------------	------------

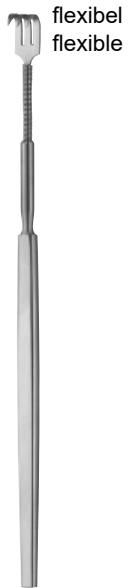

stumpf
blunt

15,5 cm – 6"

MA 4465-01	MA 4465-02	MA 4465-03	MA 4465-04
------------	------------	------------	------------



scharf
sharp



stumpf
blunt

16 cm – 6¼"

MA 4466-01	MA 4466-02
------------	------------

M.ASHRAF
INSTRUMENTS



JACKSON

13 cm – 5"

MA 4468-13



BERGMANN





14 cm – 5½"

MA 4469-14



Wund- und Trachealhäkchen Wound and Trachea Retractors



	
scharf <i>sharp</i>	stumpf <i>blunt</i>
16 cm – 6¼"	
Fig. 1	Fig. 2
MA 4471-01	MA 4471-02



scharf
sharp

11,5 cm – 4½"

MA 4472-02	MA 4472-03	MA 4472-04	MA 4472-06
-------------------	-------------------	-------------------	-------------------



stumpf
blunt

11,5 cm – 4½"

MA 4473-02	MA 4473-03	MA 4473-04	MA 4473-06
-------------------	-------------------	-------------------	-------------------



LITTLE

12 x 14 mm



20 cm – 8"

MA 4455-20



LOVE (MORSE)

1:3



25 cm – 10"

10 mm	MA 4456-10
15 mm	MA 4456-15
20 mm	MA 4456-20
30 mm	MA 4456-30
40 mm	MA 4456-40
50 mm	MA 4456-50



CUSHING

1:3



25 cm – 10"

11 x 14 mm	MA 4456-81
13 x 18 mm	MA 4456-82
15 x 22 mm	MA 4456-83



CUSHING

Breite Width	20 cm – 8"
8 mm	MA 4474-08
10 mm	MA 4474-10
12 mm	MA 4474-12
14 mm	MA 4474-14
16 mm	MA 4474-16
18 mm	MA 4474-18

M.ASHRAF
INSTRUMENTS

Wundhaken Retractors



CUSHING



Breite Width	24 cm – 9½"
8 mm	MA 4474-58
10 mm	MA 4474-60
12 mm	MA 4474-62
14 mm	MA 4474-64
16 mm	MA 4474-66
18 mm	MA 4474-68



DESMARRES



Breite Width	14 cm – 5½"
8 mm	MA 4475-08
10 mm	MA 4475-10
11 mm	MA 4475-11
12 mm	MA 4475-12
13 mm	MA 4475-13
14 mm	MA 4475-14
15 mm	MA 4475-15
16 mm	MA 4475-16
18 mm	MA 4475-18

M.ASHRAF
INSTRUMENTS



CRILE

12 x 4 mm

20 x 6 mm

11 cm – 4¼"

MA 4478-11



LUER

11 cm – 4¼"

MA 4479-11

Wundhaken Retractors

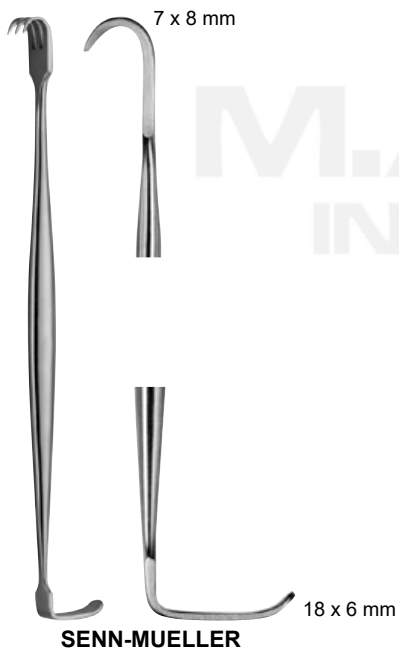
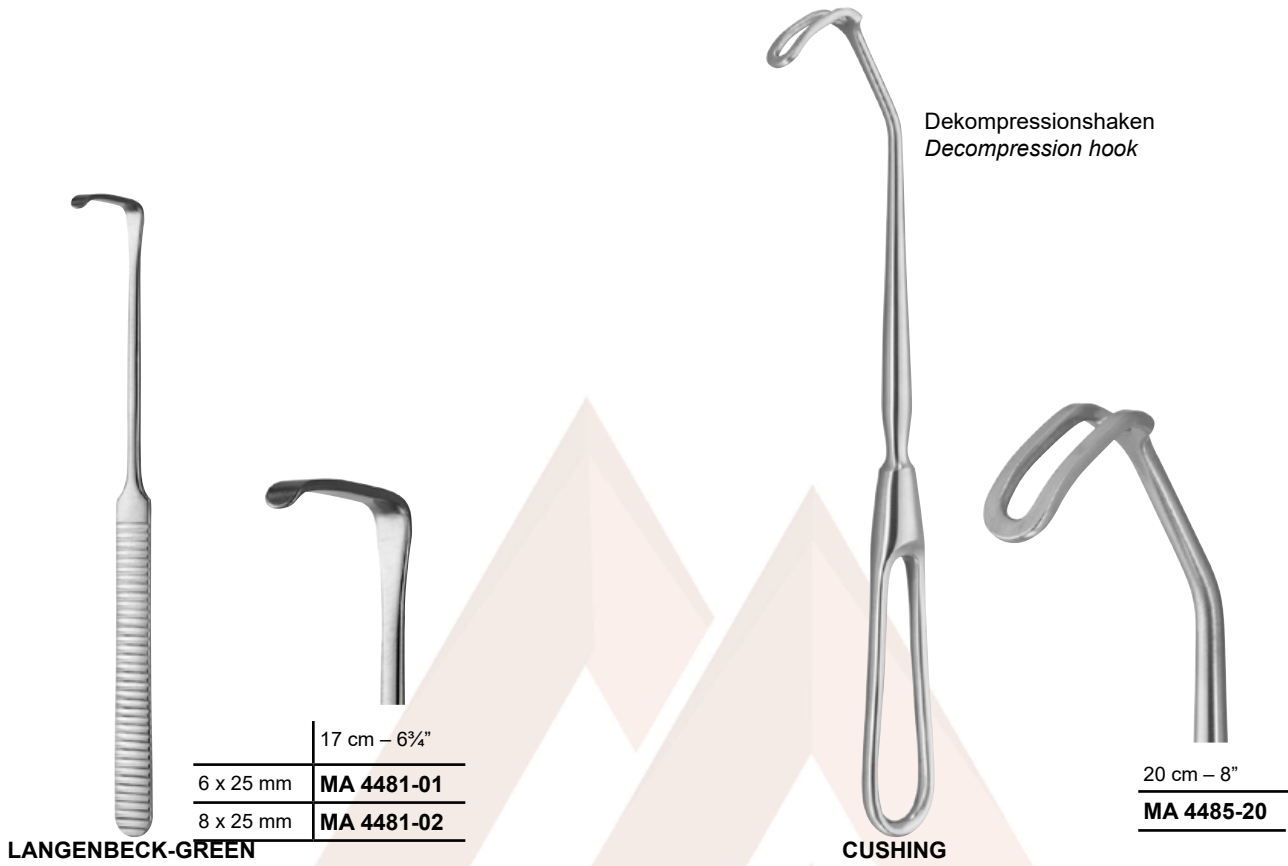

scharf <i>sharp</i>	stumpf <i>blunt</i>
16 cm – 6 1/4"	
MA 4486-01	MA 4486-02

M.ASHRAF
INSTRUMENTS

Wundhaken Retractors

7 x 8 mm

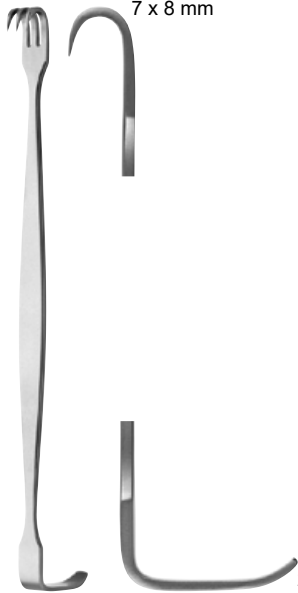

BABY-SENN-MUELLER

22 x 7 mm

scharf
sharp

stumpf
blunt

15,5 cm – 6"

MA 4487-01

MA 4487-02

7 x 3,5 mm

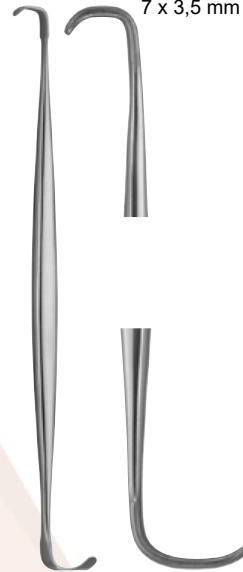

RAGNELL-DAVIS

14 x 5 mm

15 cm – 6"

MA 4488-14



SENN-GREEN

10 x 6 mm



MA 4489-01

20 x 6 mm



MA 4489-02

16 cm – 6¼"



MA 4490-01



MA 4490-02



MA 4490-03

scharf
sharp

16 cm – 6¼"



LANGENBECK-GREEN

11 x 13 mm



MA 4490-13

16 x 6 mm



MA 4490-16

25 x 6 mm



MA 4490-25

16 cm – 6¼"



ROUX

MA 4492-00

Satz bestehend aus:
MA 4492-01, MA 4492-02, MA 4492-03
Set consisting of:
MA 4492-01, MA 4492-02, MA 4492-03

14 cm – 5½"	Fig. 1	MA 4492-01
15 cm – 6"	Fig. 2	MA 4492-02
17 cm – 6¾"	Fig. 3	MA 4492-03



BABY-ROUX

17 x 16 mm

18 x 22 mm

13 cm – 5"

MA 4492-13

30 x 31 mm



GOELET

37 x 40 mm

19 cm – 7½"

MA 4493-19

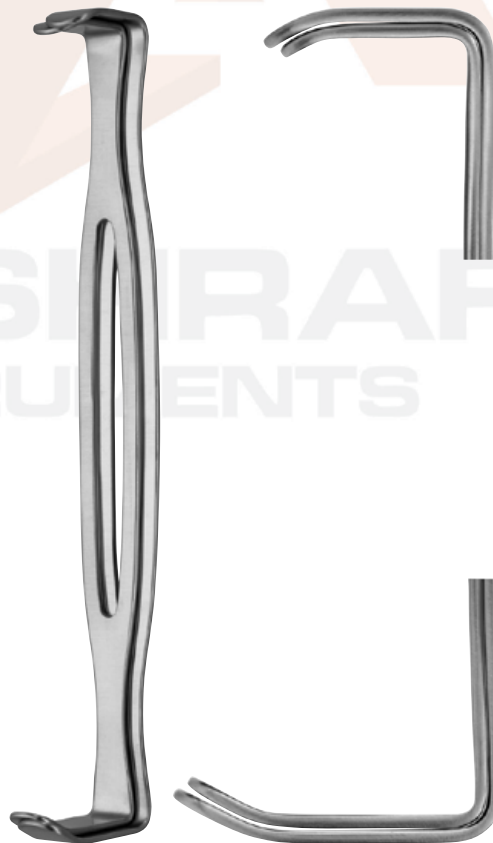

PARKER-LANGENBECK

Satz
Set

21 cm – 8¼"

MA 4494-21

Wundhaken Retractors



Satz
Set
13,5 cm – 5¼"
MA 4495-13

PARKER



Satz
Set
18 cm – 7"
MA 4495-18

PARKER



Satz
Set
16 cm – 6¼"
MA 4496-00

PARKER-MOTT



Satz
Set
12 cm – 4¾"
MA 4497-12

FARABEUFF



Satz
Set
15 cm – 6"
MA 4497-15

FARABEUFF

Wundhaken Retractors



COLLIN

Satz
Set

16,5 cm – 6½"

MA 4498-00



MATHIEU

Satz
Set

19 cm – 7½"

MA 4499-00



OLLIER

M.ASHRAF
INSTRUMENTS

36 x 30 mm

36 x 55 mm



1:2



1:2

22,5 cm – 8¾"

MA 4510-03

MA 4510-04

Wundhaken Retractors

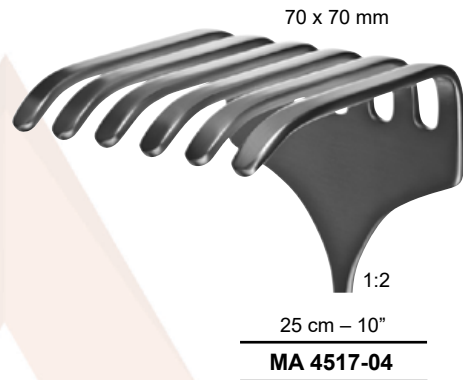
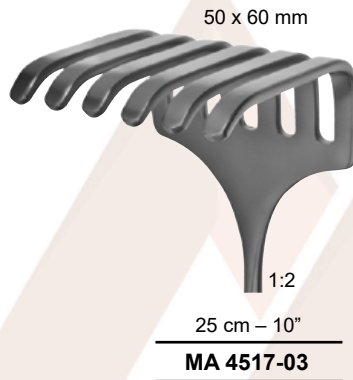
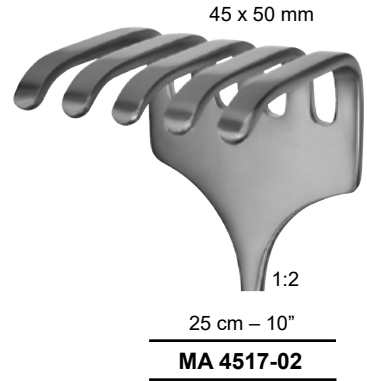
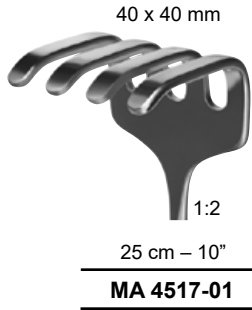

Griff vertikal
vertical handle

23 cm – 9"
MA 4518-00



25 cm – 10"
MA 4521-08



Griff vertikal
vertical handle

21,5 cm – 8½"
MA 4522-21

Wundhaken Retractors



LANGENBECK

	21 cm – 8¼"
55 x 20 mm	MA 4522-01
63 x 20 mm	MA 4522-02
60 x 20 mm	MA 4522-05



LANGENBECK

	23 cm – 9"
35 x 7 mm	MA 4523-01
35 x 10 mm	MA 4523-02
35 x 15 mm	MA 4523-03
60 x 20 mm	MA 4523-04

28 x 6 mm



LAHEY

	19 cm – 7½"
	MA 4525-19



SAUERBRUCH

	22,5 cm – 8¾"
45 x 15 mm	MA 4526-01
55 x 23 mm	MA 4526-02
72 x 20 mm	MA 4526-03

M.ASHRAF
INSTRUMENTS



Wundhaken Retractors



LANGENBECK

38 x 20 mm



21 cm – 8¼"

30 x 11 mm	MA 4530-01
30 x 14 mm	MA 4530-02
33 x 14 mm	MA 4530-03
30 x 16 mm	MA 4530-04
40 x 11 mm	MA 4530-05
42 x 13 mm	MA 4530-06
50 x 11 mm	MA 4530-07



LANGENBECK

Hohlheftgriff
Hollow handle

22 cm – 8¾"

30 x 11 mm	MA 4531-01
40 x 11 mm	MA 4531-05
42 x 13 mm	MA 4531-06



KOCHER

22 cm – 8¾"

MA 4535-01



KOCHER

19 cm – 7½"

19 x 12 mm	MA 4536-01
21 x 12 mm	MA 4536-02



Wundhaken Retractors



KOCHER-LANGENBECK

	21,5 cm – 8½"
25 x 6 mm	MA 4538-11
25 x 8 mm	MA 4538-12
35 x 8 mm	MA 4538-13
35 x 11 mm	MA 4538-14
35 x 15 mm	MA 4538-15
40 x 11 mm	MA 4538-16
55 x 11 mm	MA 4538-17
70 x 14 mm	MA 4538-18
80 x 12 mm	MA 4538-19
80 x 16 mm	MA 4538-20



CASPAR

67 x 17 mm
21,5 cm – 8½"
MA 4537-21



KOCHER

	23 cm – 9"
40 x 18 mm	MA 4539-11
60 x 20 mm	MA 4539-12
60 x 25 mm	MA 4539-13
75 x 30 mm	MA 4539-14
75 x 40 mm	MA 4539-15



KOCHER-WAGNER

	28 cm – 11"
22 x 15 mm	MA 4540-01
38 x 20 mm	MA 4540-02
67 x 25 mm	MA 4540-03
100 x 35 mm	MA 4540-04

M.ASHRAF
INSTRUMENTS



Wundhaken Retractors

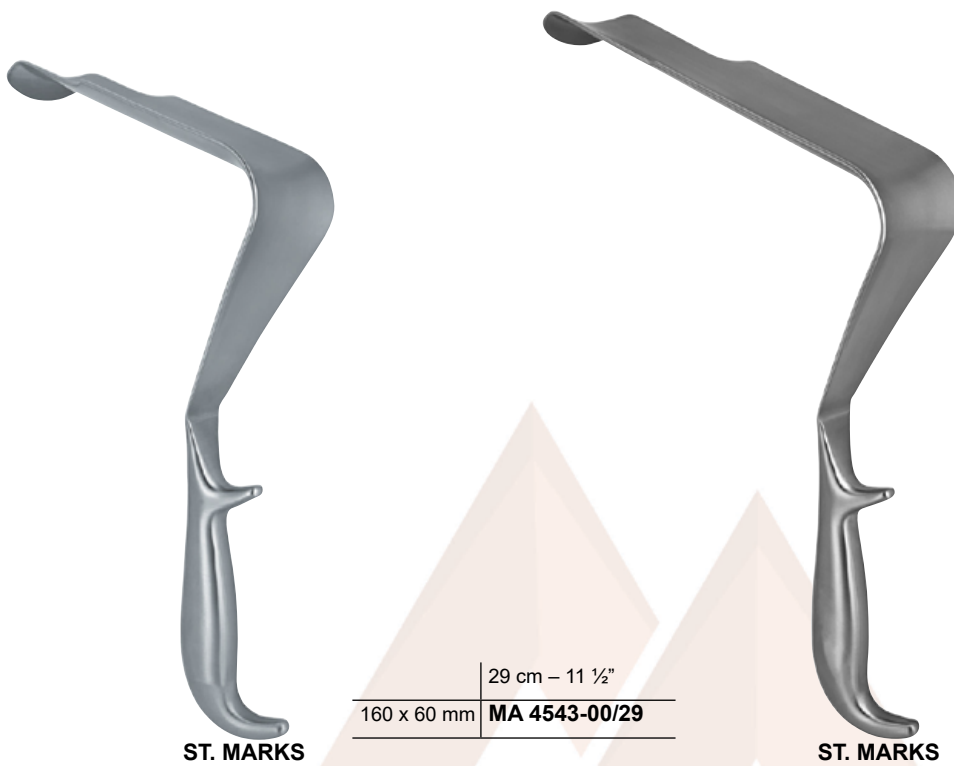

ST. MARKS

160 x 60 mm	29 cm – 11 ½"
MA 4543-00/29	

ST. MARKS

180 x 60 mm	32,5 cm – 12 ¾"
MA 4543-00/32	



ST. MARKS

180 x 60 mm	33 cm – 13"
MA 4543-00/33	



	25 cm – 10"
60 x 20 mm	MA 4542-01
80 x 30 mm	MA 4542-02
100 x 30 mm	MA 4542-03
120 x 30 mm	MA 4542-04
140 x 30 mm	MA 4542-05
140 x 40 mm	MA 4542-06



	21 cm – 8¼"
70 x 40 mm	MA 4544-40
70 x 50 mm	MA 4544-50
70 x 65 mm	MA 4544-65



19 cm – 7½"	16 mm	MA 4544-47
19 cm – 7½"	20 mm	MA 4544-48
20 cm – 8"	25 mm	MA 4544-49



	24 cm – 9½"
32 x 50 mm / 38 x 50 mm	MA 4544-01
45 x 50 mm / 50 x 50 mm	MA 4544-02
65 x 50 mm / 38 x 50 mm	MA 4544-03

M.ASHRAF
INSTRUMENTS

Wundhaken Retractors



WYLIE

30,5 cm – 12"	75 x 23 mm	MA 4548-30
33 cm – 13"	175 x 23 mm	MA 4548-33



GREEN

22 cm – 8¾"	MA 4549-22
-------------	-------------------



MIDDELDORPF

21,5 cm – 8½"	14 x 17 mm	MA 4551-01
22 cm – 8¾"	20 x 22 mm	MA 4551-02
23,5 cm – 9¼"	26 x 30 mm	MA 4551-03



MIDDELDORPF

25,5 cm – 10"	
45 x 45 mm	MA 4551-51
45 x 50 mm	MA 4551-52
55 x 70 mm	MA 4551-53

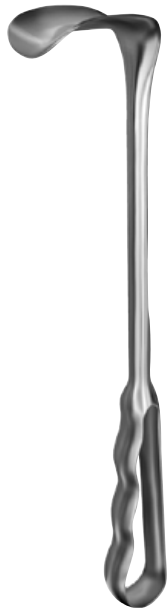

1:3

RICHARDSON

	24 cm – 9½"
28 x 20 mm	MA 4552-11
30 x 28 mm	MA 4552-12
38 x 37 mm	MA 4552-13
52 x 22 mm	MA 4552-14

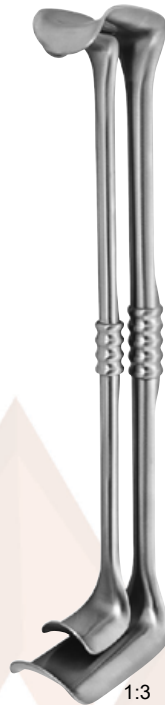

1:3

RICHARDSON-EASTMAN

MA 4553-00

Satz bestehend aus:
MA 4553-01, MA 4553-02

Set consisting of:
MA 4553-01, MA 4553-02

25 cm – 10"	24 x 22 mm / 30 x 30 mm	Fig. 1	MA 4553-01
27 cm – 10½"	40 x 37 mm / 65 x 43 mm	Fig. 2	MA 4553-02

51 x 19 mm



1:3

RICHARDSON

	23,5 cm – 9¼"
	MA 4552-55



1:3

RICHARDSON

	24 cm – 9½"
64 x 41 mm	MA 4552-51
25 x 19 mm	MA 4552-52
32 x 25 mm	MA 4552-53
38 x 38 mm	MA 4552-54

M.ASHRAF
INSTRUMENTS

Wundhaken Retractors



	26 cm – 10¼"
40 x 50 mm	MA 4554-00
50 x 65 mm	MA 4554-01
65 x 75 mm	MA 4554-02
75 x 90 mm	MA 4554-03

KELLY



	25 cm – 10"
51 x 38 mm	MA 4554-50
64 x 51 mm	MA 4554-51
76 x 64 mm	MA 4554-52
89 x 76 mm	MA 4554-53

KELLY



	24 cm – 9½"
45 x 40 mm	MA 4555-01
45 x 50 mm	MA 4555-02
45 x 60 mm	MA 4555-03
45 x 75 mm	MA 4555-04
65 x 85 mm	MA 4555-05

FRITSCH



	25 cm – 10"
50 x 85 mm	MA 4556-25

DOYEN



Wundhaken Retractors



1:3
DOYEN-STILLE

	24 cm – 9½"
15 x 90 mm	MA 4557-01
20 x 90 mm	MA 4557-02
30 x 90 mm	MA 4557-03
35 x 110 mm	MA 4557-04
40 x 110 mm	MA 4557-05
55 x 120 mm	MA 4557-06

70 x 25 mm



1:3
KOCHER

	22,5 cm – 8¾"
	MA 4557-22



1:3
KOCHER

	25 cm – 10"
80 x 42 mm	MA 4558-01
80 x 50 mm	MA 4558-02
80 x 60 mm	MA 4558-03



1:3
SIMON

	28 cm – 11"
115 x 22 mm	MA 4560-01
115 x 27 mm	MA 4560-02

M.ASHRAF
INSTRUMENTS



Wundhaken Retractors

105 x 27 mm



1:3
MARTÍN

26 cm – 10¼"

MA 4562-26



1:3
BRUNNER

	25 cm – 10"
80 x 20 mm	MA 4563-08
100 x 25 mm	MA 4563-10
120 x 25 mm	MA 4563-12
130 x 30 mm	MA 4563-13
140 x 30 mm	MA 4563-14
160 x 30 mm	MA 4563-16
180 x 30 mm	MA 4563-18

19 mm



DEAVER

18 cm – 7"

MA 4570-01

22 mm



DEAVER

21,5 cm – 8½"

MA 4570-02

25 mm

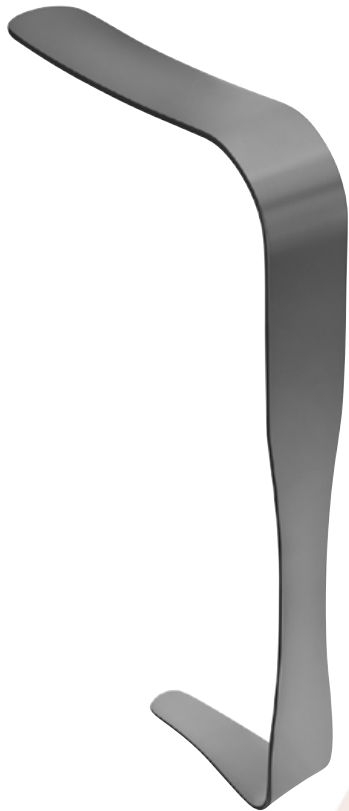

DEAVER

23 cm – 9"

MA 4570-03

25 mm



1:3
DEAVER

30 cm – 11¼"	MA 4570-04
33 cm – 13"	MA 4570-05
36 cm – 14¼"	MA 4570-06



1:3
DEAVER

	30 cm – 11¼"
38 mm	MA 4570-07
50 mm	MA 4570-08
75 mm	MA 4570-09



Hohlgriff
Hollow handle

1:3
DEAVER

	30 cm – 11¼"
25 mm	MA 4571-04
38 mm	MA 4571-07
50 mm	MA 4571-08
75 mm	MA 4571-09

Wundhaken Retractors



1:3
HARRINGTON

	32 cm – 12½"
40 x 127 mm	MA 4572-01
62 x 127 mm	MA 4572-02



MEYERDING

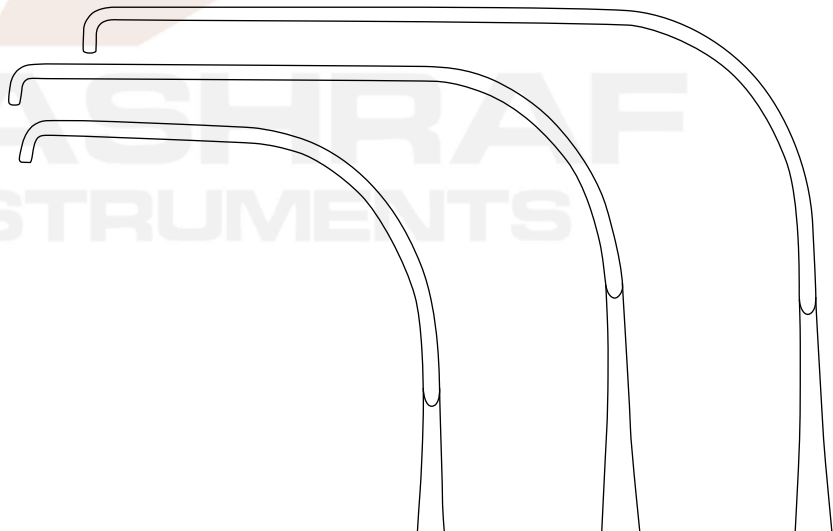

52 x 16 mm	76 x 25 mm	89 x 50 mm
23 cm – 9"	23 cm – 9"	25,5 cm – 10"
MA 4573-01	MA 4573-02	MA 4573-03





HIBBS

MA 4575-00

Satz bestehend aus:
MA 4575-01, MA 4575-02

Set consisting of:
MA 4575-01, MA 4575-02

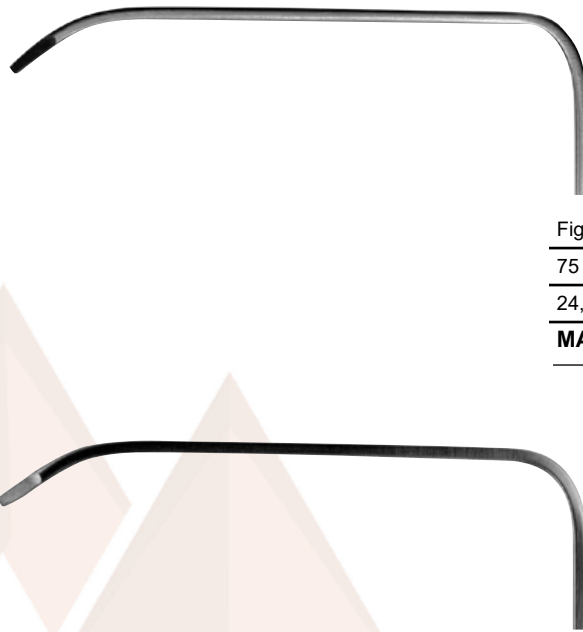

Fig. 1

75 x 25 mm

24,5 cm – 9¾"

MA 4575-01

Fig. 2

80 x 25 mm

24,5 cm – 9¾"

MA 4575-02

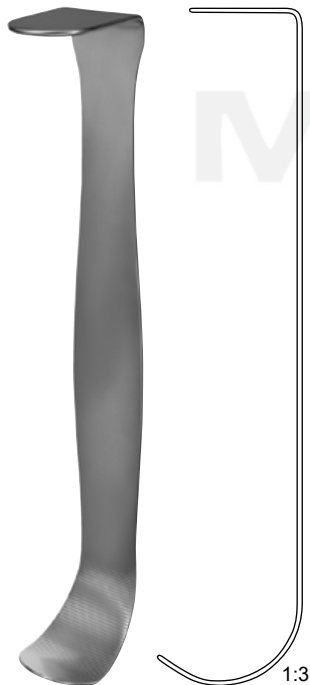

HEANEY

	27 cm – 10½"
45 x 25 mm	MA 4575-51
73 x 28 mm	MA 4575-52
82 x 28 mm	MA 4575-53



LERICHE

45 mm

25,5 cm – 10"

MA 4579-01

60 mm

27,5 cm – 10¾"

MA 4579-02

Wundhaken Retractors



1:3
BRUNNER

	25,5 cm – 10"
80 x 20 mm	MA 4564-01
100 x 20 mm	MA 4564-02
120 x 25 mm	MA 4564-03
140 x 25 mm	MA 4564-04



1:3
MIKULICZ

	26 cm – 10¼"
85 x 35 mm	MA 4565-01
120 x 50 mm	MA 4565-02
155 x 50 mm	MA 4565-03



1:3
MIKULICZ

	26 cm – 10¼"
	MA 4566-26



1:3
KELLY

	27 cm – 10½"
160 x 38 mm	MA 4567-01
160 x 57 mm	MA 4567-02
190 x 38 mm	MA 4567-51
190 x 57 mm	MA 4567-52

Wundhaken Retractors

	16 cm – 6¼"
75 x 50 mm	MA 4590-01
75 x 90 mm	MA 4590-02

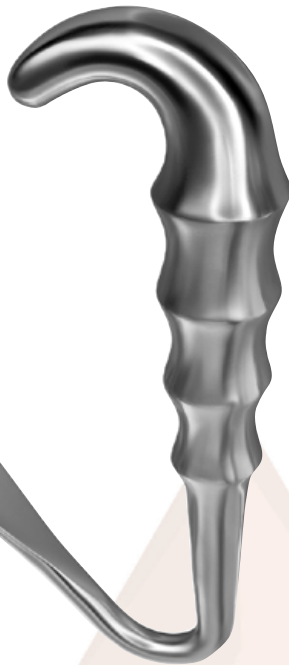

DAVIDSON



ROSS

		27 cm – 10½"
Fig. 1	15 x 16 mm	MA 4593-01
Fig. 2	13 x 23 mm	MA 4593-02
Fig. 3	17 x 23 mm	MA 4593-03
Fig. 4	13 x 27 mm	MA 4593-04
Fig. 5	29 x 29 mm	MA 4593-05
Fig. 6	40 x 21 mm	MA 4593-06



COOLEY



1:2

35 x 45 mm
21,5 cm – 8½"

MA 4591-01



1:2

45 x 50 mm
21,5 cm – 8½"

MA 4591-02



1:2

20 x 50 mm
26 cm – 10¼"

MA 4591-03

M.ASHRAF
INSTRUMENTS

Spatel Spatulas



1:3

biegsam
malleable

	33 cm – 13"
20 mm	MA 4580-20
25 mm	MA 4580-25
30 mm	MA 4580-30
35 mm	MA 4580-35
40 mm	MA 4580-40
45 mm	MA 4580-45
50 mm	MA 4580-50
64 mm	MA 4580-64
76 mm	MA 4580-76
102 mm	MA 4580-99



biegsam
malleable

17 / 25 mm
20 cm – 8"
MA 4582-20

TUFFIER



biegsam
malleable

20 cm – 8"	6 mm	MA 4584-06
	8 mm	MA 4584-08
	10 mm	MA 4584-10
	12 mm	MA 4584-12
	17 mm	MA 4584-17
	20 mm	MA 4584-20
25 cm – 10"	25 mm	MA 4584-25
	25 mm	MA 4584-29



1:3

biegsam
malleable

28 cm – 11"	25 / 30 mm	MA 4585-01
30 cm – 11¼"	37 / 45 mm	MA 4585-02
	40 / 50 mm	MA 4585-03

HABERER



1:3

28,5 cm – 11¼"
MA 4587-28

REVERDIN

Wundspreizer Self-retaining Retractors



2 : 3 Zähne
2 : 3 teeth

	scharfsharp	stumpfb blunt
5 cm – 2"	MA 4640-05	MA 4641-05

FINSEN



3 : 4 Zähne
3 : 4 teeth

	scharfsharp	stumpfb blunt
7 cm – 2¾"	MA 4640-07	MA 4641-07

FINSEN

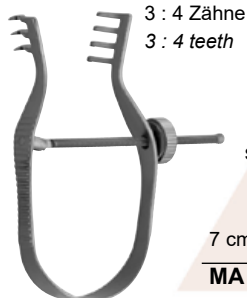

3 : 4 Zähne
3 : 4 teeth

scharf
sharp

7 cm – 2¾"	MA 4642-07
------------	-------------------

FINSEN

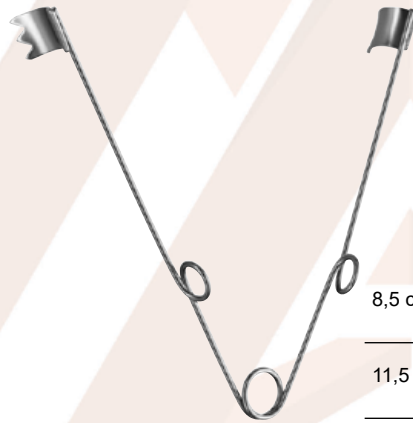

8,5 cm – 3¼"

Spreizweite: 60 mm
Spread: 60 mm

MA 4643-08

11,5 cm – 4½"

Spreizweite: 60 mm
Spread: 60 mm

MA 4643-11

M.ASHRAF
INSTRUMENTS



ALM

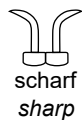

7 cm – 2¾"	MA 4650-07	MA 4651-07
10 cm – 4"	–	MA 4651-10



HEISS



10 cm – 4"	
MA 4655-00	MA 4655-10

Wundspreizer Self-retaining Retractors

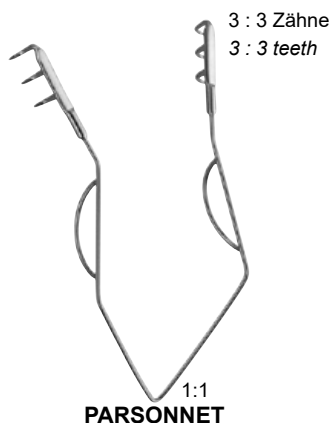

Größe Size	Epicardial Wundspreizer Epicardial retractors	
25 mm	Spreizweite: 15 mm Spread: 15 mm	MA 4660-01
33 mm	Spreizweite: 19 mm Spread: 19 mm	MA 4660-02
38 mm	Spreizweite: 24 mm Spread: 24 mm	MA 4660-03
52 mm	Spreizweite: 32 mm Spread: 32 mm	MA 4660-04

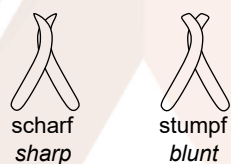

10 cm – 4"

Spreizweite: 45 mm Spread: 45 mm	MA 4680-10	MA 4681-10
-------------------------------------	-------------------	-------------------

M.ASHRAF
INSTRUMENTS

Wundspreizer Self-retaining Retractors

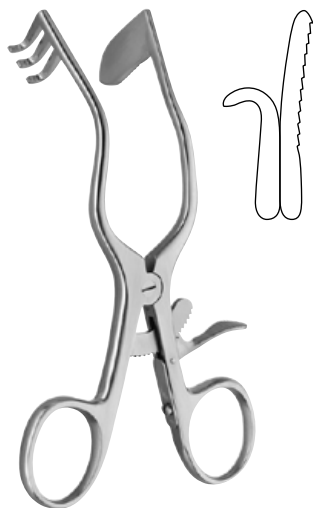

PERKINS

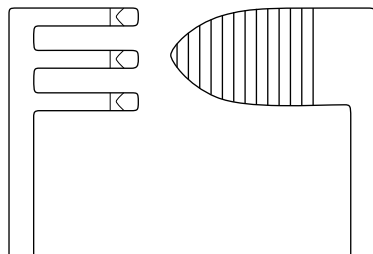

volles Blatt rechts,
scharf gezahnt

*solid blade right,
sharp serrated*

13 cm – 5"

MA 4688-01

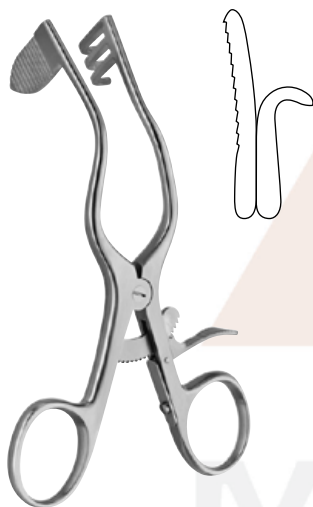

PERKINS

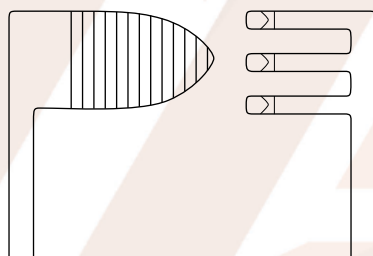

volles Blatt links,
scharf gezahnt

*solid blade left,
sharp serrated*

13 cm – 5"

MA 4688-02

M.ASHRAF
INSTRUMENTS

Wundspreizer Self-retaining Retractors

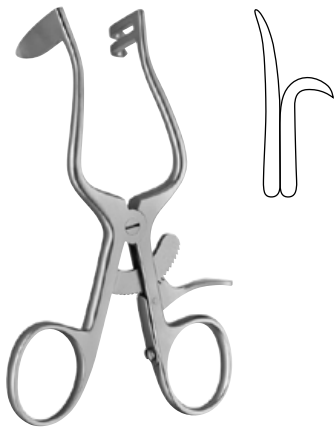

PLESTER

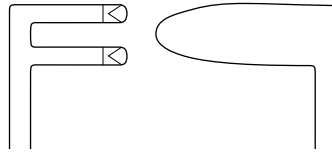

Spreizweite: 55 mm
Spread: 55 mm

Blatt links voll
Blatt rechts 2 Zähne, scharf
Blade left solid, sharp
Blade left 2 teeth, sharp

11 cm – 4 1/4"

MA 4690-01



PLESTER

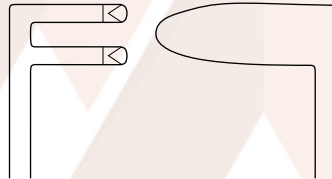

Spreizweite: 55 mm
Spread: 55 mm

Blatt rechts voll
Blatt links 2 Zähne, scharf

Blade right solid, sharp
Blade left 2 teeth, sharp

11 cm – 4 1/4"

MA 4690-02



PLESTER

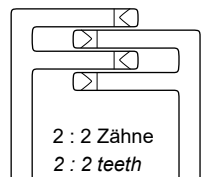

Spreizweite: 60 mm
Spread: 60 mm

scharf stumpf
sharp *blunt*

13 cm – 5"

MA 4691-01

MA 4691-02

Wundspreizer Self-retaining Retractors

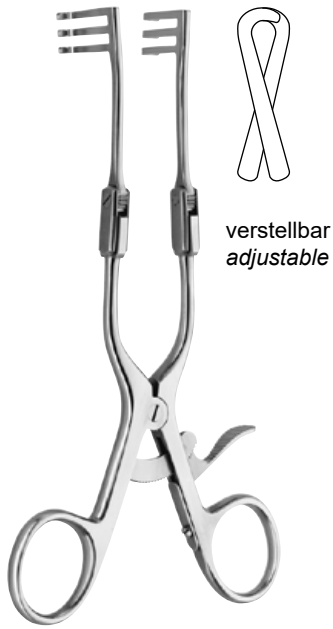

FISH

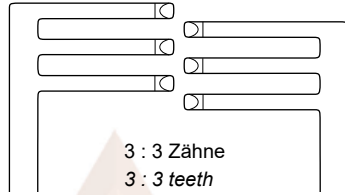

stumpf
blunt

17 cm – 6¾"

MA 4694-11

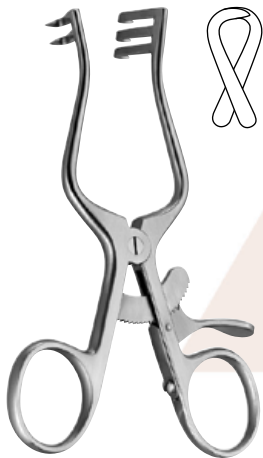

WEITLANER

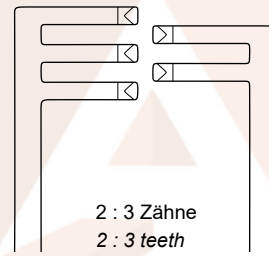

scharf
sharp

stumpf
blunt

halbscharf
semi-sharp

10,5 cm – 4¼"

MA 4700-10

MA 4701-10

MA 4702-10



WEITLANER

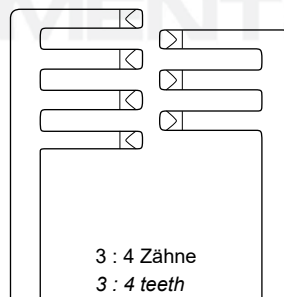

scharf
sharp

stumpf
blunt

halbscharf
semi-sharp

13 cm – 5"

MA 4700-13

MA 4701-13

MA 4702-13

16,5 cm – 6½"

MA 4700-16

MA 4701-16

MA 4702-16

Wundspreizer Self-retaining Retractors

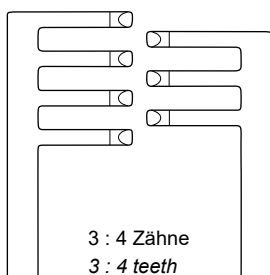

3 : 4 Zähne
3 : 4 teeth

stumpf
blunt

14 cm – 5½"

MA 4709-10

JEFFERSEN

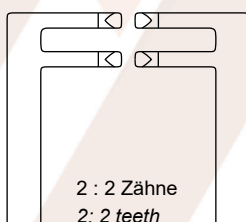

2 : 2 Zähne
2 : 2 teeth

scharf
sharp

14 cm – 5½"

MA 4709-20

MOLLISON

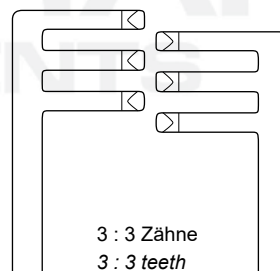

3 : 3 Zähne
3 : 3 teeth

scharf
sharp

stumpf
blunt

13 cm – 5"

Spreizweite: 45 mm
Spread: 45 mm

MA 4710-13

MA 4711-13

16,5 cm – 6½"

Spreizweite: 75 mm
Spread: 75 mm

MA 4710-16

MA 4711-16

WEITLANER-WULLSTEIN

Wundspreizer Self-retaining Retractors



MOLLISON

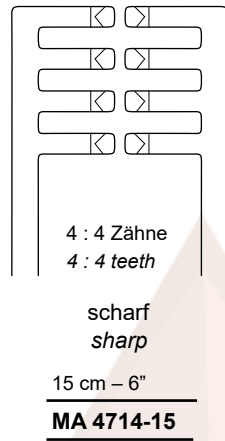

CLOWARD

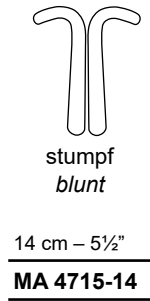

**TÜBINGER MODELL
TUEBINGEN PATTERN**

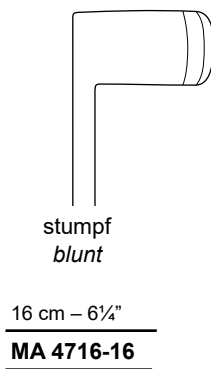

M.ASHRAF
INSTRUMENTS

Wundspreizer Self-retaining Retractors



MAYO-ADAMS

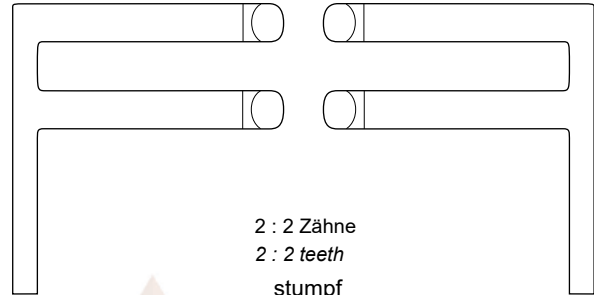
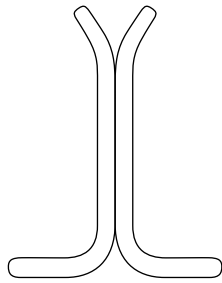

2 : 2 Zähne
2 : 2 *teeth*
stumpf
blunt

17 cm – 6¾"

MA 4755-17



MAYO-ADAMS

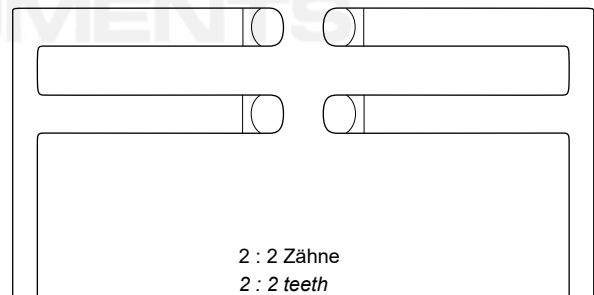
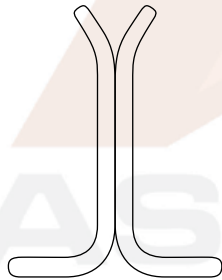

2 : 2 Zähne
2 : 2 *teeth*
stumpf
blunt

17 cm – 6¾"

MA 4756-17

Wundspreizer Self-retaining Retractors

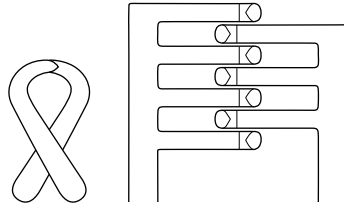

scharf
sharp

Wundsperrer komplett, bestehend aus:
Retractor complete, consisting of: **MA 4718-00**

Sperrer
Retractor

3 Mittelvalven (MA 4718-19, -25, -32)
3 *Central blades* (MA 4718-19, -25, -32)



HENLEY

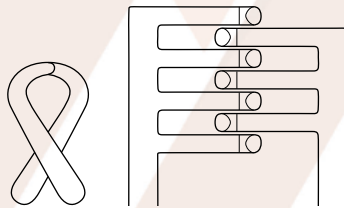

stumpf
blunt

Wundsperrer komplett, bestehend aus:
Retractor complete, consisting of: **MA 4718-01**

Sperrer
Retractor

3 Mittelvalven (MA 4718-19, -25, -32)
3 *Central blades* (MA 4718-19, -25, -32)

M.ASHRAF
INSTRUMENTS



Mittelvalven
Central blades

19 x 16 mm	25 x 16 mm	32 x 16 mm
MA 4718-19	MA 4718-25	MA 4718-32

Wundspreizer Self-retaining Retractors



HENLEY

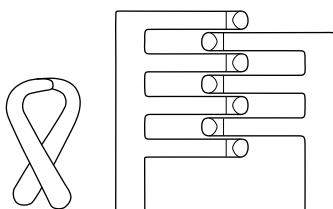

Standard

Sperrer, allein 17 cm – 6¾" <i>Retractor, only 17 cm – 6¾"</i>	MA 4719-17
Wundsperrer komplett, bestehend aus: <i>Retractor complete, consisting of:</i>	MA 4719-20
Sperrer allein (MA 4719-17) <i>Retractor only (MA 4719-17)</i>	
3 Mittelvalven (MA 4719-21, -22, -23) <i>3 Central blades (MA 4719-21, -22, -23)</i>	

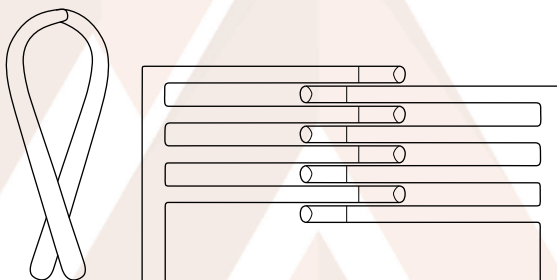

Tiefes Modell
Deep Type

Sperrer, allein 17 cm – 6¾" <i>Retractor, only 17 cm – 6¾"</i>	MA 4719-27
Wundsperrer komplett, bestehend aus: <i>Retractor complete, consisting of:</i>	MA 4719-30
Sperrer allein (MA 4719-27) <i>Retractor only (MA 4719-27)</i>	
3 Mittelvalven (MA 4719-21, -22, -23) <i>3 Central blades (MA 4719-21, -22, -23)</i>	



Mittelvalven
Central blades

Fig. 1	Fig. 2	Fig. 3
20 x 16 mm	25 x 16 mm	30 x 16 mm
MA 4719-21	MA 4719-22	MA 4719-23

Wundspreizer Self-retaining Retractors

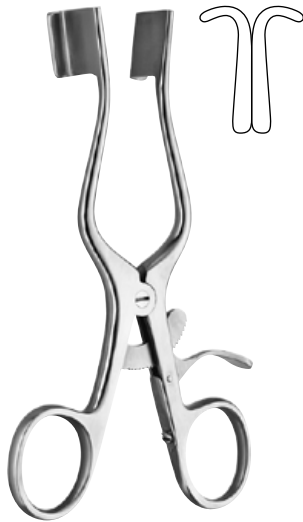

WEITLANER-BABY

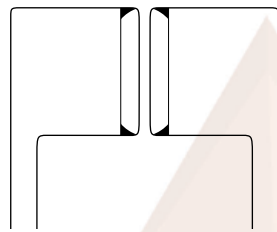

stumpf
blunt

13 cm – 5"

MA 4719-13



MILLIGAN

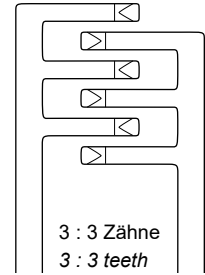

scharf
sharp

stumpf
blunt

13 cm – 5"

MA 4720-13

MA 4721-13



CONE (ADSON-BABY)

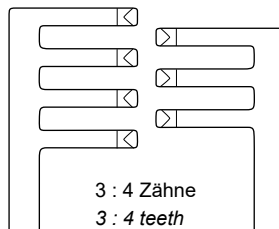

scharf
sharp

stumpf
blunt

3 : 4 Zähne
3 : 4 teeth

14 cm – 5½"

MA 4722-13

MA 4723-13

16 cm – 6¼"

MA 4722-16

MA 4723-16

M.ASHRAF
INSTRUMENTS

Wundspreizer Self-retaining Retractors



WEITLANER

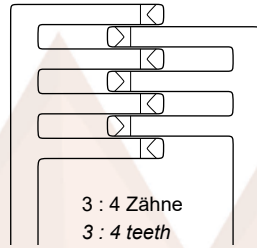

scharf stumpf
sharp *blunt*

20 cm – 8"

MA 4724-20 | **MA 4725-20**

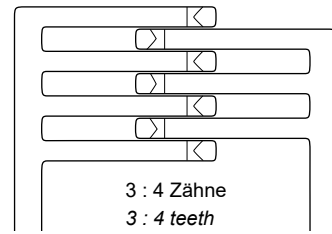

scharf stumpf
sharp *blunt*

24 cm – 9½"

MA 4724-25 | **MA 4725-25**



WEITLANER

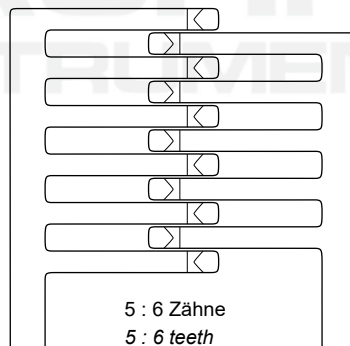

scharf stumpf
sharp *blunt*

25 cm – 10"

MA 4726-25 | **MA 4727-25**

Wundspreizer Self-retaining Retractors



ADSON

4 : 4 Zähne 4 : 4 teeth	
scharf sharp	stumpf blunt
19,5 cm – 7 ³ / ₄ "	
MA 4728-20	MA 4729-20



ANDERSON-ADSON

4 : 4 Zähne
4 : 4 teeth

scharf sharp	stumpf blunt
20 cm – 8"	
MA 4730-20	MA 4731-20

ASHRAF
INSTRUMENTS

Wundspreizer Self-retaining Retractors



ADSON

1:3

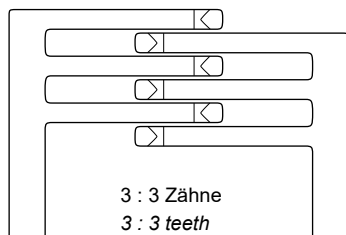
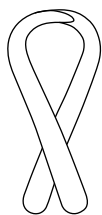

3 : 3 Zähne
3 : 3 teeth
scharf
sharp

24 cm – 9½"

MA 4732-24



CONE

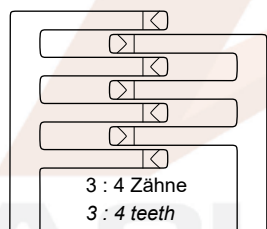

3 : 4 Zähne
3 : 4 teeth

scharf stumpf
sharp blunt

21 cm – 8¼"

MA 4734-20

MA 4735-20

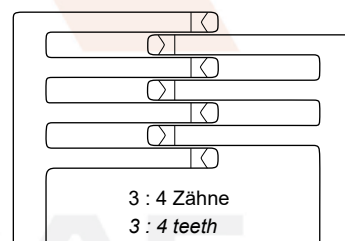

3 : 4 Zähne
3 : 4 teeth

scharf stumpf
sharp blunt

25 cm – 10"

MA 4734-26

MA 4735-26



Wundspreizer Self-retaining Retractors



TRAVERS

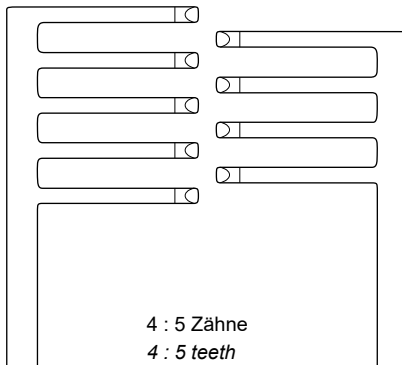
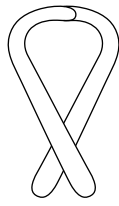

4 : 5 Zähne
4 : 5 teeth

stumpf
blunt

21 cm – 8¼"

MA 4738-21

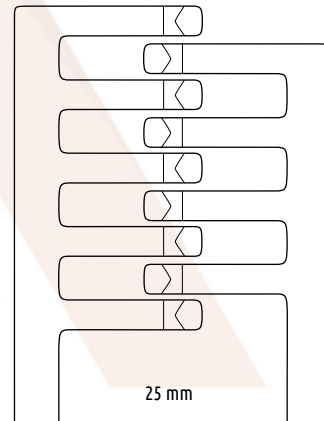

25 mm



BECKMANN-ADSON

4 : 5 Zähne
4 : 5 teeth

1:3

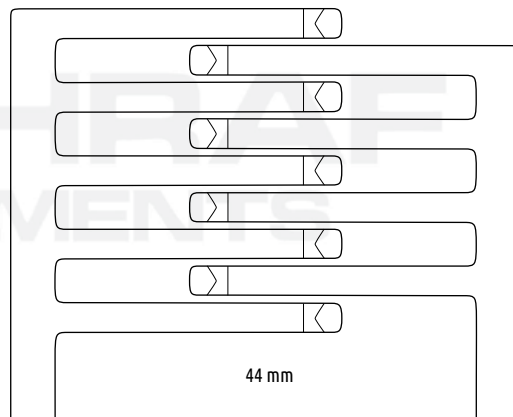

44 mm

scharf
sharp

stumpf
blunt

31 cm – 12¼"

25mm	MA 4739-01	MA 4739-11	MA 4739-21
44mm	MA 4739-02	MA 4739-12	MA 4739-22



Wundspreizer Self-retaining Retractors



scharf
sharp

stumpf
blunt

21 cm – 8¼"

MA 4740-27	MA 4741-27
------------	------------

ADSON

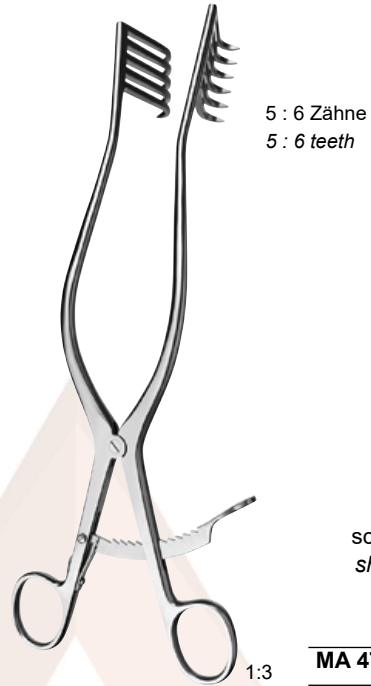

scharf
sharp

stumpf
blunt

27 cm – 10½"

MA 4740-51	MA 4741-51
------------	------------

ADSON

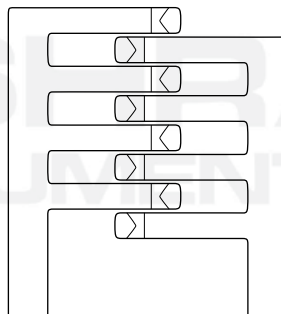

4 : 4 Zähne
4 : 4 teeth

scharf
sharp

stumpf
blunt

halbscharf
semisharp

31 cm – 12¼"

MA 4742-31	MA 4743-31	MA 4743-41
------------	------------	------------

BECKMANN-ADSON
(STANDARD)

Wundspreizer Self-retaining Retractors



ADSON

1:3

stumpf
blunt

33 cm – 13"

MA 4743-33



Hemilaminektome-Sperrer
Hemilaminectomy retractor

1:3

scharf
sharp

28 cm – 11"

MA 4745-27

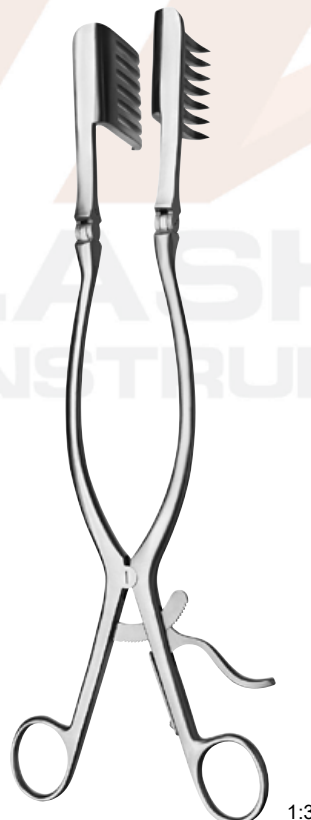

BECKMANN-EATON

1:3

scharf
sharp

33 cm – 13"

MA 4749-33

Spezialwundspreizer Special Retractors

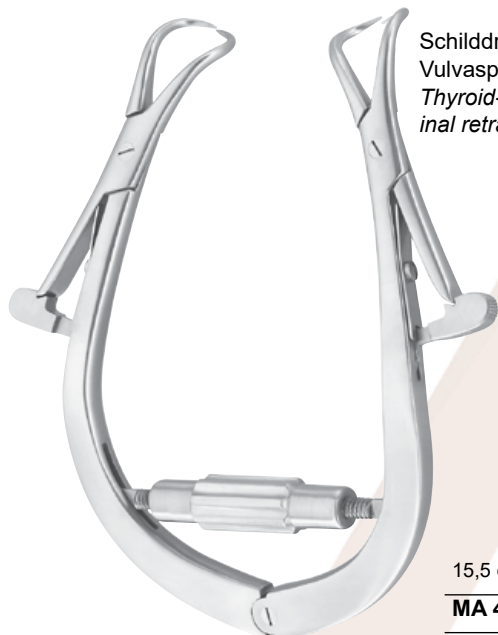

Schilddrüsen- und
Vulvaspreizer
*Thyroid- and vag-
inal retractor*

15,5 cm – 6"

MA 4761-00

JOLL (FRIEDMANN)



Haut- und Vulvaspreizer
Skin- and vaginal retractor

9,5 cm – 3¾" | **MA 4761-09**

12 cm – 4¾" | **MA 4761-11**

13,5 cm – 5¼" | **MA 4761-13**

19 cm – 7½" | **MA 4761-19**

GELPI



Haut- und
Vulvaspreizer
*Skin- and
vaginal retractor*

19 cm – 7½"

MA 4763-19

GELPI



Blätterblades | 19 cm – 7"

32 x 25 mm | **MA 4764-01**

54 x 25 mm | **MA 4764-02**

60 x 25 mm | **MA 4764-04**

MEYERDING

Wundspreizer Self-retaining Retractors



MARHAM-MEYERDING

18 cm – 7"

MA 4765-01

MA 4765-02



RIGBY

19 cm – 7½"

MA 4767-19



DE BAKEY

12 cm – 4¾" | **MA 4768-12**

17 cm – 6¾" | **MA 4768-17**

M.ASHRAF
INSTRUMENTS

Bauchdeckenhalter Abdominal Retractors



COLLIN



BABY-COLLIN

Sperrer allein,
Spreizweite: 100 mm
*Retractor only,
spread: 100 mm*

MA 4750-50

Bauchdeckenhalter komplett mit
einem Paar Blätter MA 4750-51
*Abdominal retractor complete with
one pair of blades MA 4750-51*

MA 4750-00

Blätter seitlich, 1 Paar (38 x 60 mm)
Blades lateral, 1 pair (38 x 60 mm)

MA 4750-51

Bauchdeckenhalter (Spreizweite: 80 mm) komplett mit
2 Paar Blätter (28 x 42 mm, 18 x 42 mm)
*Abdominal retractor (spread: 80 mm) complete with
two pairs of blades (28 x 42 mm, 18 x 42 mm)*

MA 4751-00

Blätter seitlich, 1 Paar (18 x 42 mm)
Blades lateral, 1 pair (18 x 42 mm)

MA 4751-51

Blätter seitlich, 1 Paar (28 x 42 mm)
Blades lateral, 1 pair (28 x 42 mm)

MA 4751-52

Bauchdeckenhalter Abdominal Retractors

Fig. 1

Sperrer allein, Spreizweite: 110 mm <i>Retractor only, spread: 110 mm</i>	MA 4752-50
---	-------------------

Bauchdeckenhalter komplett, bestehend aus: <i>Abdominal retractor complete, consisting of:</i>	MA 4752-00
---	-------------------

Sperrer allein (MA 4752-50) <i>Retractor only (MA 4752-50)</i>	
1 Paar Blätter seitlich, 38 x 62 mm (MA 4752-51) 1 pair of blades lateral, 38 x 62 mm (MA 4752-51)	
1 Mittelblatt, 55 x 55 mm (MA 4752-55) 1 Central blade, 55 x 55 mm (MA 4752-55)	



COLLIN

Fig. 2

Sperrer allein, Spreizweite: 110 mm <i>Retractor only, spread: 110 mm</i>	MA 4754-50
---	-------------------

Bauchdeckenhalter komplett, bestehend aus: <i>Abdominal retractor complete, consisting of:</i>	MA 4754-00
---	-------------------

Sperrer allein (MA 4754-50) <i>Retractor only (MA 4754-50)</i>	
1 Paar Blätter seitlich, 38 x 80 mm (MA 4754-51) 1 pair of blades lateral, 38 x 80 mm (MA 4754-51)	

Fig. 3

Sperrer allein, Spreizweite: 110 mm <i>Retractor only, spread: 110 mm</i>	MA 4754-60
---	-------------------

Bauchdeckenhalter komplett, bestehend aus: <i>Abdominal retractor complete, consisting of:</i>	MA 4754-10
---	-------------------

Sperrer allein (MA 4754-60) <i>Retractor only (MA 4754-60)</i>	
1 Paar Blätter seitlich, 38 x 100 mm (MA 4754-61) 1 pair of blades lateral, 38 x 100 mm (MA 4754-61)	
1 Mittelblatt, 55 x 75 mm (MA 4754-65) 1 Central blade, 55 x 75 mm (MA 4754-65)	

Bauchdeckenhalter Abdominal Retractors

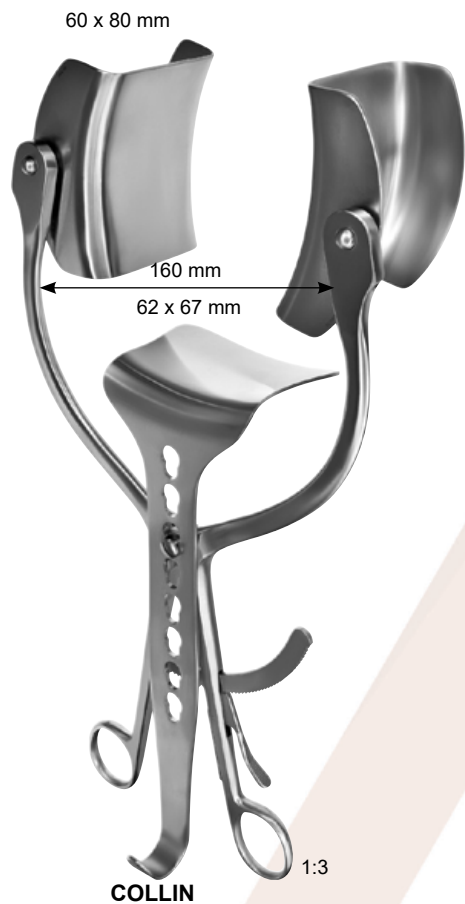

Sperrer allein
Retractor only

MA 4754-76

Bauchdeckenhalter komplett, bestehend aus:
Abdominal retractor complete, consisting of:

MA 4754-70

Sperrer allein (MA 4754-76)
Retractor only (MA 4754-76)

1 Paar Blätter seitlich, 60 x 80 mm (MA 4754-71)

1 pair of blades lateral, 60 x 80 mm (MA 4754-71)

1 Mittelblatt, 62 x 67 mm (MA 4754-75)

1 Central blade, 62 x 67 mm (MA 4754-75)

M.ASHRAF
INSTRUMENTS

Bauchdeckenhalter Abdominal Retractors



RICARD

Fig. 1

Sperrer allein <i>Retractor only</i>	MA 4758-11
Bauchdeckenhalter komplett, bestehend aus: <i>Abdominal retractor complete, consisting of:</i>	MA 4758-01
Sperrer allein (MA 4758-11) <i>Retractor only (MA 4758-11)</i>	
1 Paar Blätter seitlich, 60 x 80 mm (MA 4758-21) 1 pair of blades lateral, 60 x 80 mm (MA 4758-21)	
1 Mittelblatt, 53 x 70 mm (MA 4758-31) 1 Central blade, 53 x 70 mm (MA 4758-31)	

Fig. 2

Sperrer allein <i>Retractor only</i>	MA 4758-11
Bauchdeckenhalter komplett, bestehend aus: <i>Abdominal retractor complete, consisting of:</i>	MA 4758-02
Sperrer allein (MA 4758-11) <i>Retractor only (MA 4758-11)</i>	
1 Paar Blätter seitlich, 72 x 85 mm (MA 4758-22) 1 pair of blades lateral, 72 x 85 mm (MA 4758-22)	
1 Mittelblatt, 80 x 90 mm (MA 4758-32) 1 Central blade, 80 x 90 mm (MA 4758-32)	

M.ASHRAF
INSTRUMENTS

Bauchdeckenhalter Abdominal Retractors

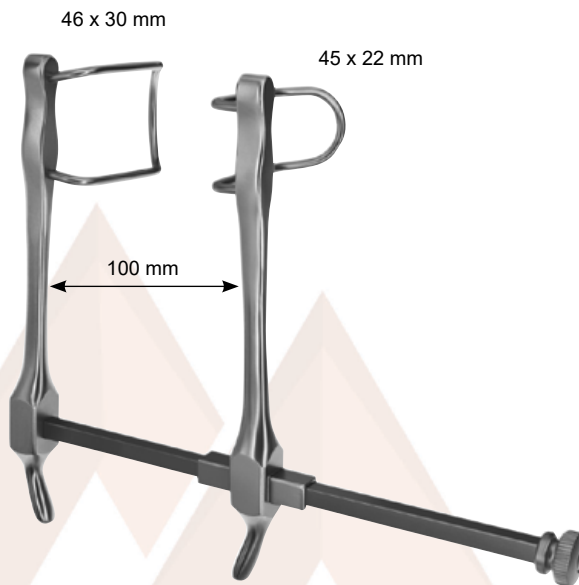

GOSSET
MA 4769-00

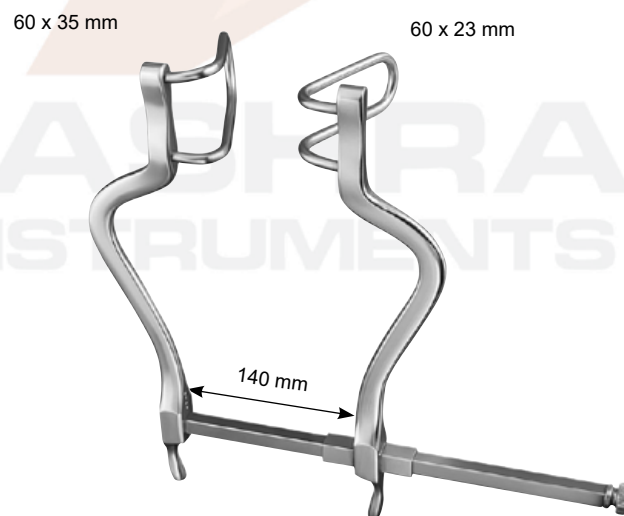

GOSSET
MA 4770-02

Bauchdeckenhalter Abdominal Retractors



GOSSET

Sperrer allein
Retractor only

MA 4771-11

Bauchdeckenhalter komplett, bestehend aus:
Abdominal retractor complete, consisting of:

MA 4771-00

Sperrer allein (MA 4771-11)
Retractor only (MA 4771-11)

1 Mittelblatt, 65 x 60 mm (MA 4771-21)
1 Central blade, 65 x 60 mm (MA 4771-21)



FRAZIER

MA 4774-00

Bauchdeckenhalter Abdominal Retractors

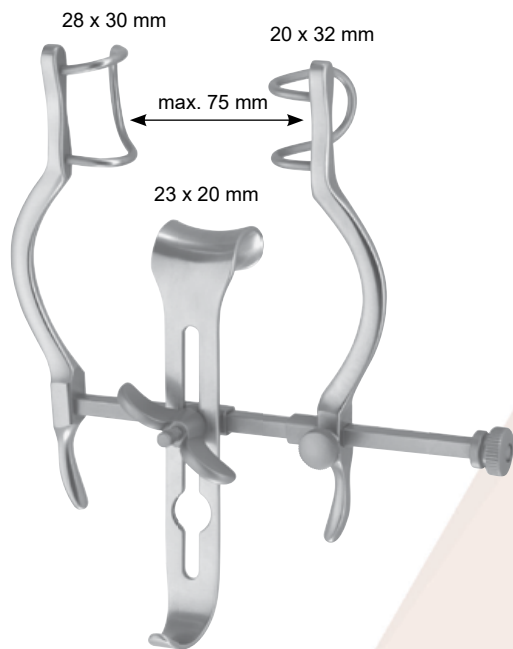

BABY-BALFOUR

Sperrer allein, Spreizweite: 75 mm <i>Retractor only, Spread: 75 mm</i>	MA 4798-11
---	-------------------

Sperrer komplett, bestehend aus: <i>Retractor complete, consisting of:</i>	MA 4798-00
---	-------------------

Sperrer allein (MA 4798-11)
Retractor only (MA 4798-11)
Mittelblatt (MA 4798-21)
Central blade (MA 4798-21)



BALFOUR

Sperrer allein, Spreizweite: 150 mm <i>Retractor only, Spread: 150 mm</i>	MA 4800-11
---	-------------------

Sperrer komplett, bestehend aus: <i>Retractor complete, consisting of:</i>	MA 4800-00
---	-------------------

Sperrer allein (MA 4800-11)
Retractor only (MA 4800-11)
Mittelblatt (MA 4800-21)
Central blade (MA 4800-21)

Bauchdeckenhalter Abdominal Retractors

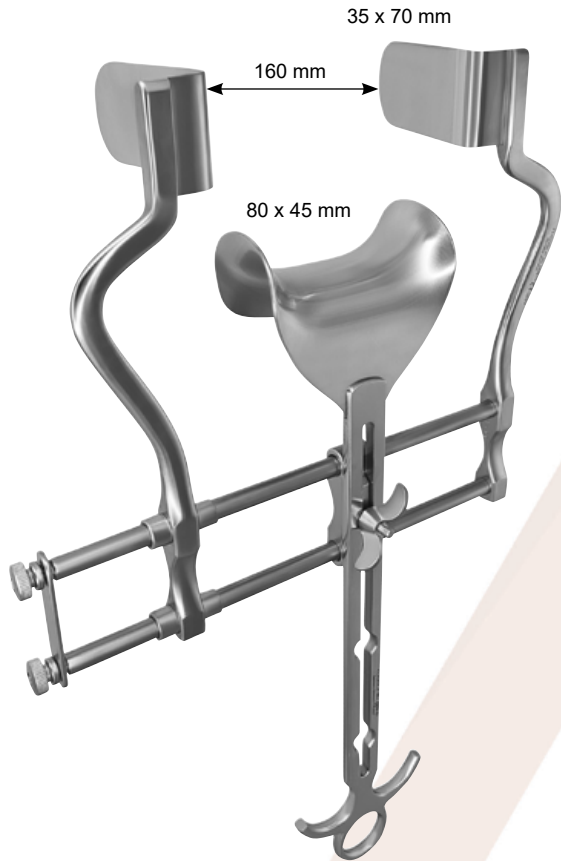

BALFOUR

Sperrer allein,
Spreizweite: 160 mm

MA 4802-11

*Retractor only,
spread: 160 mm*

Sperrer komplett, bestehend aus:
Retractor complete, consisting of:

MA 4802-00

Sperrer allein (MA 4802-11)
Retractor only (MA 4802-11)

Mittelblatt (MA 4802-21)
Central blade (MA 4802-21)

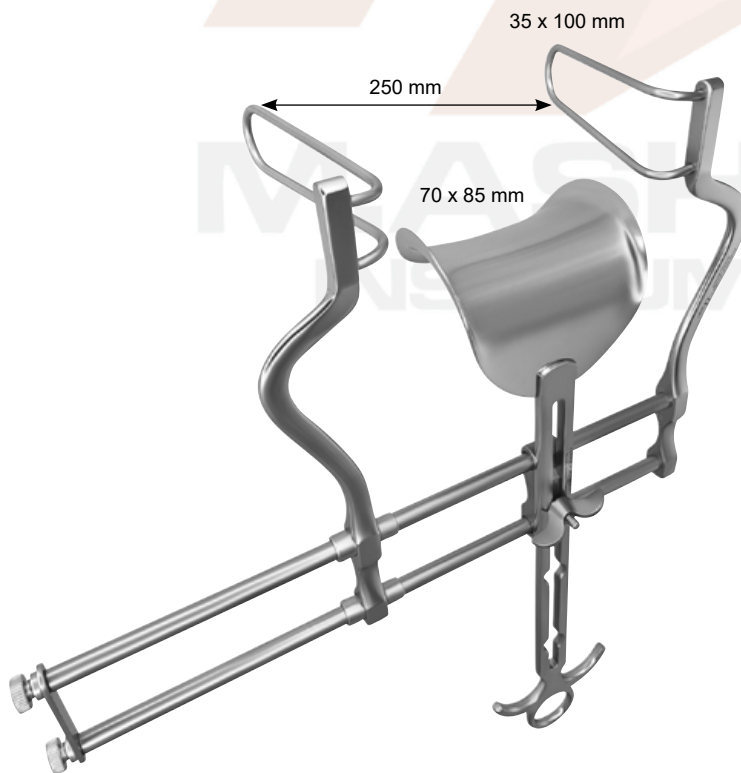

BALFOUR

Sperrer allein,
Spreizweite: 250 mm

MA 4804-11

*Retractor only,
spread: 250 mm*

Sperrer komplett, bestehend aus:
Retractor complete, consisting of:

MA 4804-00

Sperrer allein (MA 4804-11)
Retractor only (MA 4804-11)

Mittelblatt (MA 4804-21)
Central blade (MA 4804-21)

Bauchdeckenhalter Abdominal Retractors

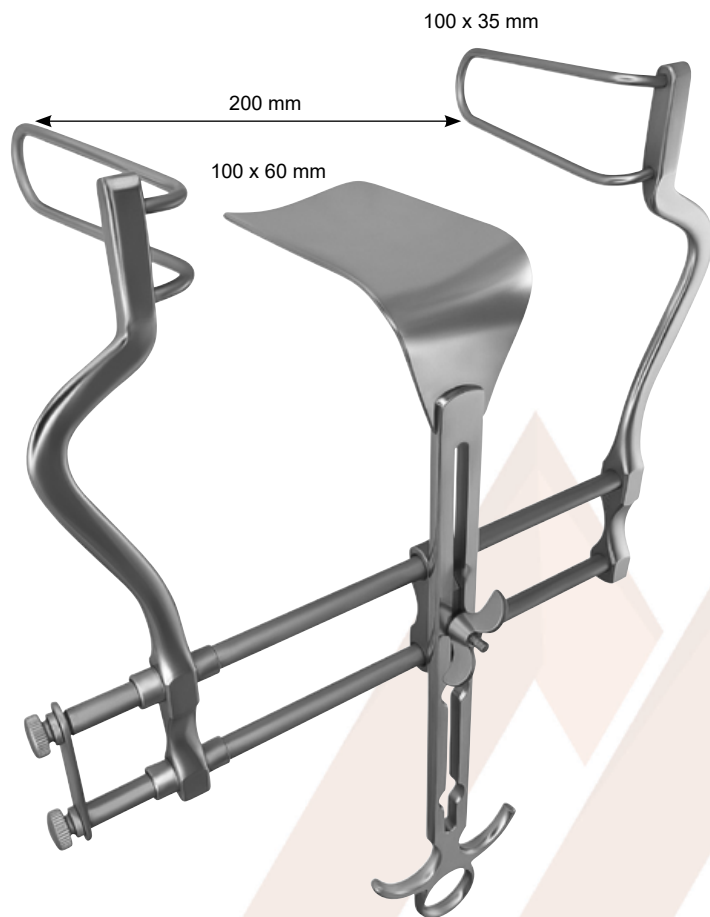

BALFOUR

Sperrer allein,
Spreizweite: 200 mm
*Retractor only,
Spread: 200 mm*

MA 4806-11

Sperrer komplett, bestehend aus:
Retractor complete, consisting of:

MA 4806-00

Sperrer allein (MA 4806-11)
Retractor only (MA 4806-11)
Mittelblatt (MA 4806-21)
Central blade (MA 4806-21)



BALFOUR USA-MODELL BALFOUR USA-PATTERN

Sperrer allein
Retractor only

MA 4807-11

Sperrer komplett, bestehend aus:
Retractor complete, consisting of:

MA 4807-00

Sperrer allein (MA 4807-11)
Retractor only (MA 4807-11)
2 Blätter seitlich, 60 mm (MA 4807-31)
2 Blades lateral, 60 mm (MA 4807-31)
2 Blätter seitlich, 80 mm (MA 4807-32)
2 Blades lateral, 80 mm (MA 4807-32)
1 Mittelblatt, 45 x 68 mm (MA 4807-21)
1 Central blade, 45 x 68 mm (MA 4807-21)
1 Mittelblatt, 68 x 85 mm (MA 4807-22)
1 Central blade, 68 x 85 mm (MA 4807-22)

Bauchdeckenhalter Abdominal Retractors

SEMM

Bauchdeckenhalter komplett,
bestehend aus:

*Abdominal retractor complete,
consisting of:*

MA 4810-00

Rahmen (MA 4810-10)
Frame (MA 4810-10)

2 Blätter (MA 4810-01)
2 Blades (MA 4810-01)

1 Blätter (MA 4810-02)
1 Blades (MA 4810-02)

1 Blätter (MA 4810-03)
1 Blades (MA 4810-03)

1 Blätter (MA 4810-04)
1 Blades (MA 4810-04)

1 Blätter (MA 4810-05)
1 Blades (MA 4810-05)

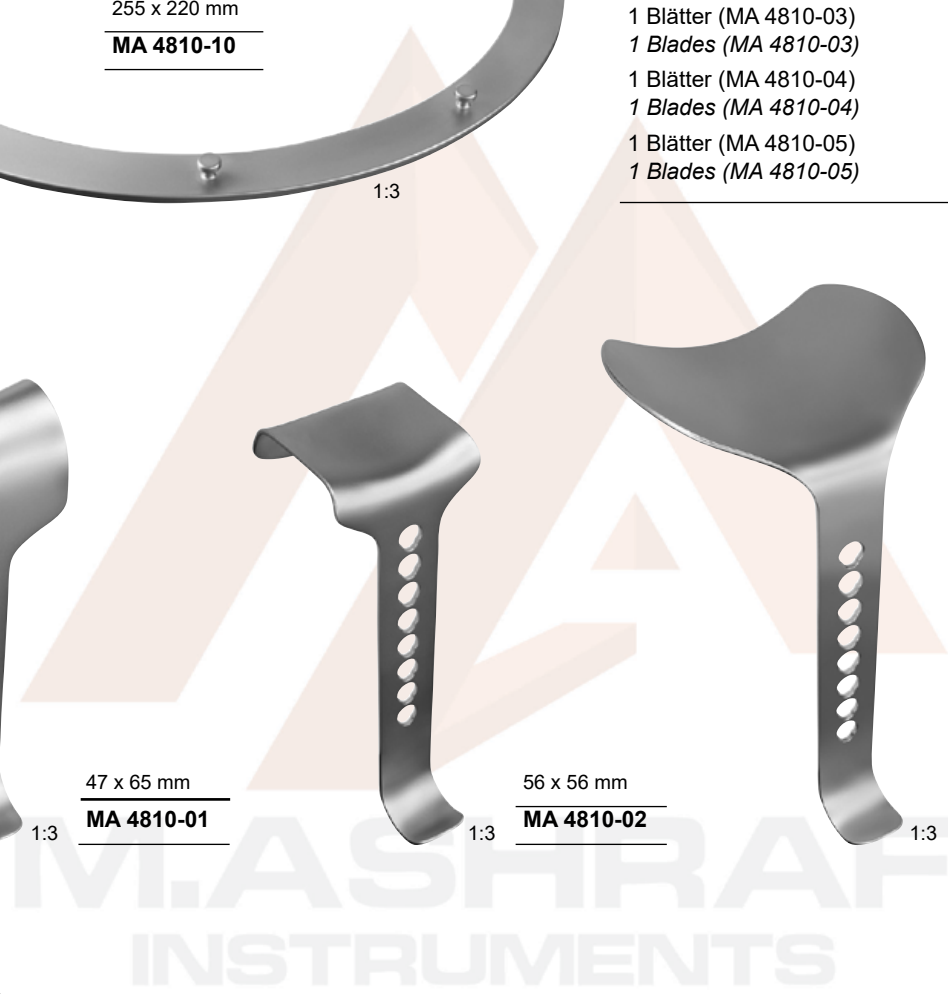
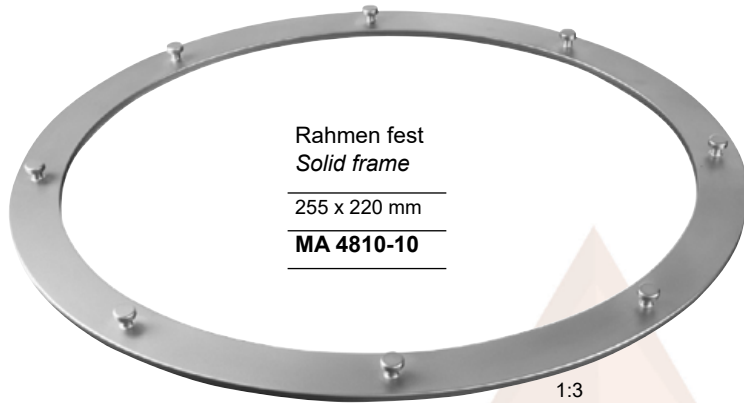

Bauchdeckenhalter Abdominal Retractors

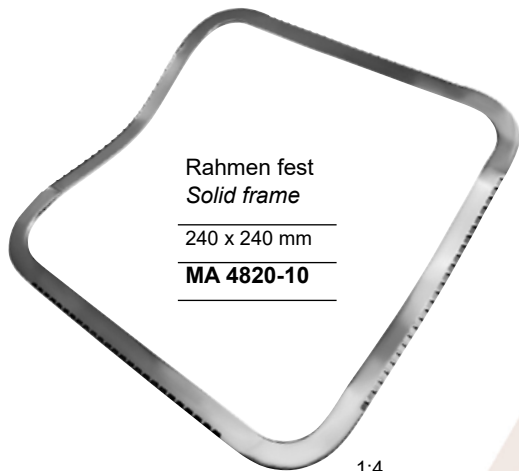

Rahmen fest
Solid frame
240 x 240 mm
MA 4820-10

1:4

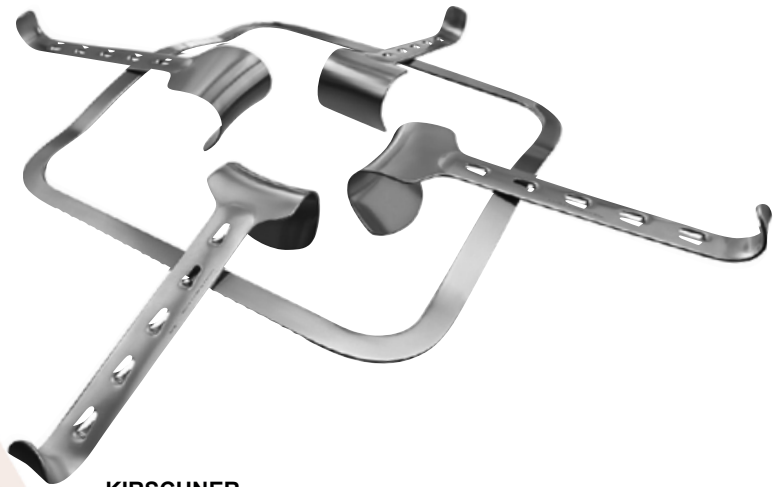

KIRSCHNER

Bauchdeckenhalter komplett, bestehend aus:
Abdominal retractor complete, consisting of:

MA 4820-00

Rahmen fest (MA 4820-10)
Solid frame (MA 4820-10)

2 Blätter, 40 x 55 mm (MA 4822-01)
2 Blades, 40 x 55 mm (MA 4822-01)
2 Blätter, 50 x 65 mm (MA 4822-02)
2 Blades, 50 x 65 mm (MA 4822-02)

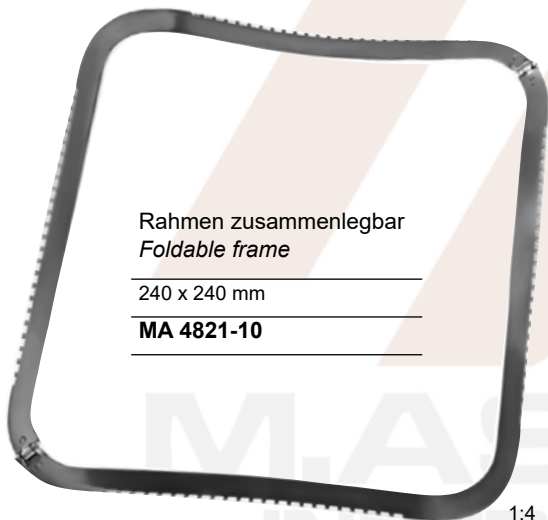

Rahmen zusammenlegbar
Foldable frame
240 x 240 mm
MA 4821-10

1:4

KIRSCHNER

Bauchdeckenhalter komplett, bestehend aus:
Abdominal retractor complete, consisting of:

MA 4821-00

Rahmen zusammenlegbar (MA 4821-10)
Foldable frame (MA 4821-10)

2 Blätter, 40 x 55 mm (MA 4822-01)
2 Blades, 40 x 55 mm (MA 4822-01)
2 Blätter, 50 x 65 mm (MA 4822-02)
2 Blades, 50 x 65 mm (MA 4822-02)



1:3

	Blätter <i>Blades</i>
40 x 55 mm	MA 4822-01
50 x 65 mm	MA 4822-02
65 x 80 mm	MA 4822-03
80 x 80 mm	MA 4822-04
90 x 65 mm	MA 4822-05
90 x 90 mm	MA 4822-06

Bauchdeckenhalter Abdominal Retractors

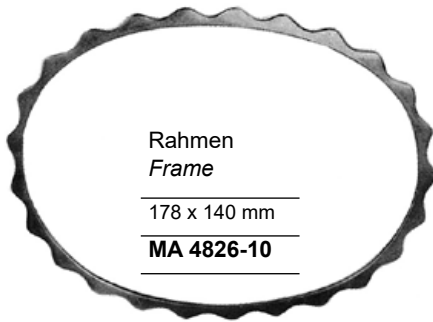

Rahmen
Frame

178 x 140 mm

MA 4826-10

DENIS-BROWN

Bauchdeckenhalter komplett, bestehend aus:
Abdominal retractor complete, consisting of:

MA 4826-00

Rahmen 178 x 140 mm (MA 4826-10)
Frame 178 x 140 mm (MA 4826-10)

2 Blätter, Fig. 1, 40 x 40 mm (MA 4828-01)
2 Blades, fig. 1, 40 x 40 mm (MA 4828-01)

2 Blätter, Fig. 2, 40 x 30 mm (MA 4828-02)
2 Blades, fig. 2, 40 x 30 mm (MA 4828-02)



1:3

Blatt, Fig. 1
Blade, fig. 1

40 x 40 mm

MA 4828-01



1:3

Blatt, Fig. 2
Blade, fig. 2

40 x 30 mm

MA 4828-02

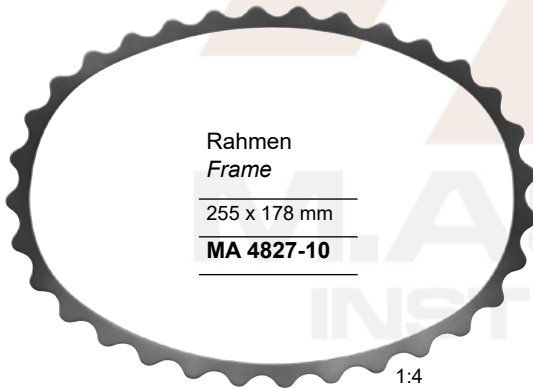

Rahmen
Frame

255 x 178 mm

MA 4827-10

1:4

DENIS-BROWN

Bauchdeckenhalter komplett, bestehend aus:
Abdominal retractor complete, consisting of:

MA 4827-00

Rahmen 255 x 178 mm (MA 4827-10)
Frame 255 x 178 mm (MA 4827-10)

2 Blätter, Fig. 1, 40 x 40 mm (MA 4828-01)
2 Blades, fig. 1, 40 x 40 mm (MA 4828-01)

2 Blätter, Fig. 2, 40 x 30 mm (MA 4828-02)
2 Blades, fig. 2, 40 x 30 mm (MA 4828-02)



1:3

Blatt, Fig. 1
Blade, fig. 1

40 x 40 mm

MA 4828-01



1:3

Blatt, Fig. 2
Blade, fig. 2

40 x 30 mm

MA 4828-02

Bauchdeckenhalter Abdominal Retractors

O'SULLIVAN-O'CONNOR

Bauchdeckenhalter komplett, bestehend aus:
Abdominal retractor complete, consisting of:

MA 4829-00

2 Mittelblätter, 80 x 45 mm (MA 4829-22)

2 Central blades, 80 x 45 mm (MA 4829-22)

1 Mittelblatt, 110 x 70 mm (MA 4829-23)

1 Central blade, 110 x 70 mm (MA 4829-23)

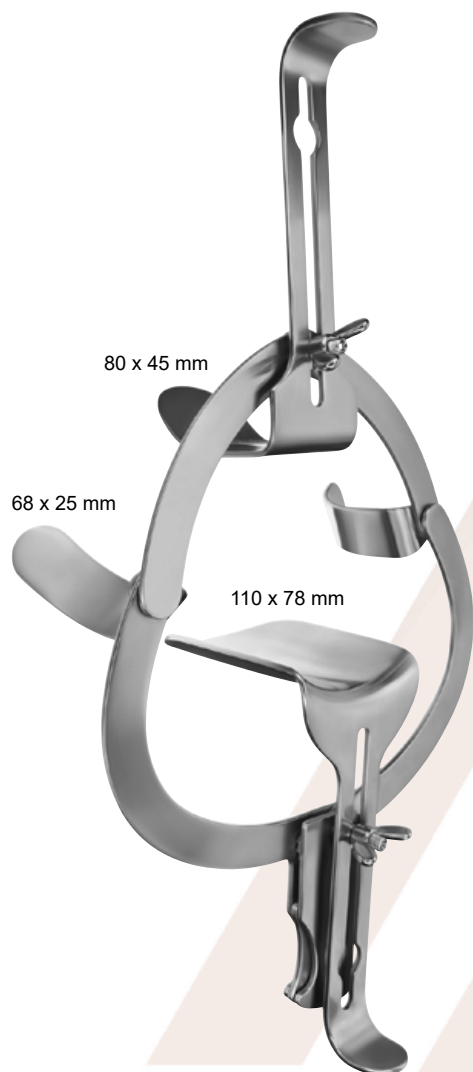

80 x 45 mm

MA 4829-22

110 x 70 mm

MA 4829-23

M.ASHRAF INSTRUMENTS

Bauchdeckenhalter Abdominal Retractors

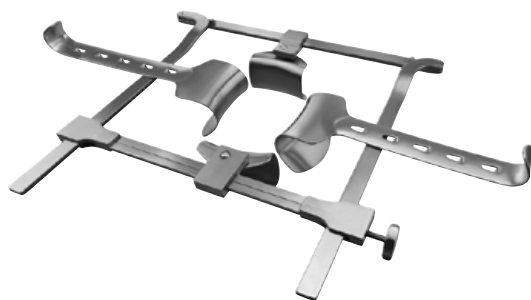

FRANZ

Bauchdeckenhalter komplett,
bestehend aus:

*Abdominal retractor complete,
consisting of:*

MA 4830-04

Rahmen zusammenlegbar (MA 4830-10)
Foldable frame (MA 4830-10)

2 Blätter, 38 x 60 mm (MA 4832-01)

2 Blades, 38 x 60 mm (MA 4832-01)

2 Blätter, 50 x 65 mm (MA 4833-01)

2 Blades, 50 x 65 mm (MA 4833-01)

FRANZ

Bauchdeckenhalter komplett,
bestehend aus:

*Abdominal retractor complete,
consisting of:*

MA 4830-08

Rahmen zusammenlegbar (MA 4830-10)
Foldable frame (MA 4830-10)

2 Blätter, 38 x 60 mm (MA 4832-01)

2 Blades, 38 x 60 mm (MA 4832-01)

2 Blätter, 50 x 65 mm (MA 4833-01)

2 Blades, 50 x 65 mm (MA 4833-01)

2 Blätter, 45 x 80 mm (MA 4832-02)

2 Blades, 45 x 80 mm (MA 4832-02)

2 Blätter, 60 x 85 mm (MA 4833-02)

2 Blades, 60 x 85 mm (MA 4833-02)

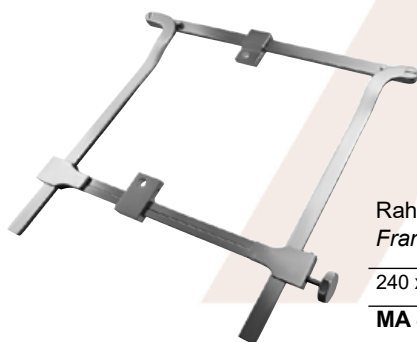

Rahmen
Frame

240 x 300 mm

MA 4830-10



1:3

Blätter
Blades

38 x 60 mm

MA 4832-01

45 x 80 mm

MA 4832-02



1:3

Blätter
Blades

50 x 65 mm

MA 4833-01

60 x 85 mm

MA 4833-02



Bauchdeckenhalter
Abdominal retractor

DOYEN

1:3

48 x 90 mm

MA 4834-01

48 x 105 mm

MA 4834-02

48 x 120 mm

MA 4834-03

48 x 135 mm

MA 4834-04

Bauchdeckenhalter Abdominal Retractors



Befestigungsgestell
Mounting frame

1:6
ROCHARD
MA 4835-01

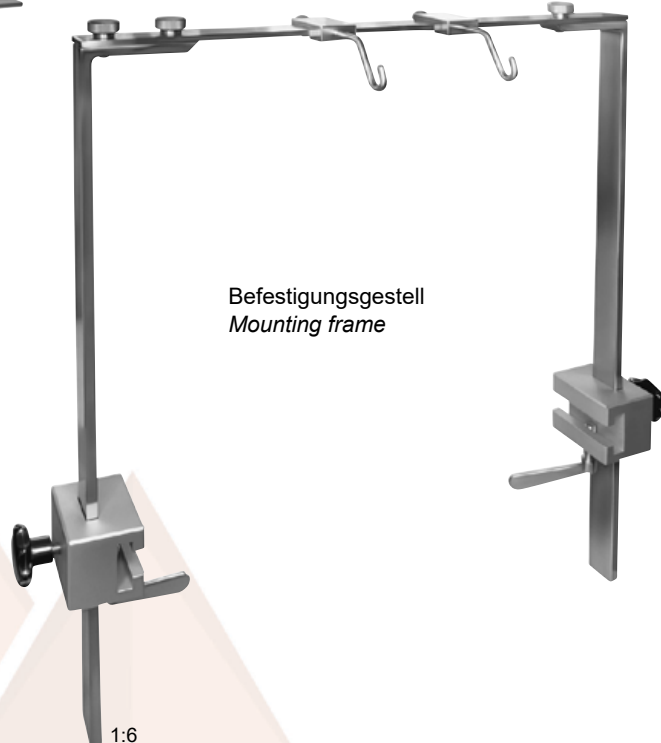

Befestigungsgestell
Mounting frame

1:6
ROCHARD
MA 4835-02



Fixiervorrichtung
Fixation device

1:3
ROCHARD
MA 4835-03



1:3
ROCHARD

	Blätter Blades
50 x 90 mm	MA 4835-09
50 x 105 mm	MA 4835-10
50 x 120 mm	MA 4835-12
55 x 135 mm	MA 4835-13
50 x 155 mm	MA 4835-15

SIX



Trokare, Saug- und Spülinstrumente, Sonden, Watteträger Trocars, Suction and Irrigation Instruments, Probes, Cotton Applicators

Trokare	<i>Trocars</i>	TS 1 - 2
Kanülen	<i>Cannulas</i>	TS 3 - 7
Saug-Raspatorien, Saug-Dissektoren	<i>Suction Raspatories, Suction Dissectors</i>	TS 8
Mikro-Saugkanülen	<i>Micro Suction Tubes</i>	TS 9
Katheterzangen	<i>Catheter Forceps</i>	TS 10
Spritzen	<i>Syringes</i>	TS 11
Luer-Lock Adapter	<i>Luer-Lock Adapter</i>	TS 12
Führungsnadeln	<i>Guide Needles</i>	TS 13
Sonden	<i>Probes</i>	TS 14 - 17
Watteträger	<i>Cotton Applicators</i>	TS 18 - 20



NELSON

Gesamtlänge Total length	Nutzlänge Working length	Außen-Ø Outer-Ø	Innen-Ø Inner-Ø	
17,5 cm – 7"	7,5 cm – 3"	3 mm	2,2 mm	MA 5200-30
	7,5 cm – 3"	3,5 mm	2,5 mm	MA 5200-35
	7,5 cm – 3"	4 mm	3 mm	MA 5200-40
	7,5 cm – 3"	4,5 mm	3,5 mm	MA 5200-45
	8 cm – 3¼"	5 mm	4 mm	MA 5200-50
	8 cm – 3¼"	5,5 mm	4,5 mm	MA 5200-55
	8,5 cm – 3¼"	6 mm	5 mm	MA 5200-60



UNIVERSAL

Trokar-Set komplett, bestehend aus:
Trocar set complete, consisting of:

MA 5212-04

- 1 Griff, flach
- 1 Handle, flat
- 1 Trokar Ø 1,7 mm
- 1 Trocar Ø 1.7 mm
- 1 Trokar Ø 3 mm
- 1 Trocar Ø 3 mm
- 1 Trokar Ø 4,5 mm
- 1 Trocar Ø 4.5 mm
- 1 Trokar Ø 6 mm
- 1 Trocar Ø 6 mm

Trokare Trocars



mit Luer-Lock Ansatz
with Luer-Lock hub

16 cm – 6¼"

MA 5220-16



14 cm – 5½"

MA 5232-16



Ø mm	15 cm – 6"
4	MA 5250-40
4,6	MA 5250-46
5,5	MA 5250-55
6,5	MA 5250-65

Ø 10 mm mit zentraler Bohrung Ø 2 mm
Ø 10 mm with central hole Ø 2 mm



27 cm – 10½"
MA 5260-27

1:3
YANKAUER-STANDARD



Ø 5 mm

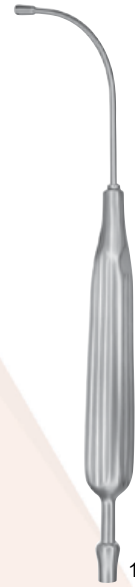

22,5 cm – 8¾"
MA 5265-00

1:3
ANDREW-PYNCHON

Ø 10 mm



22 cm – 8¾"
MA 5280-22

1:3
POOLE

Ø 8 mm



22 cm – 8¾"
MA 5281-22

1:3
POOLE

M.ASHRAF
INSTRUMENTS

Kanülen Cannulas



KLIMA-ROSEGGER

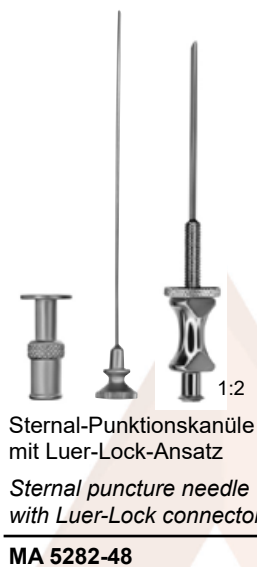

isoliert, mit Saugunterbrecher und Mandrel
insulated, with cut-off and stylet



FERGUSSON

		Arbeitslänge Working length
Ø mm	Charr./Fr.	90 mm – 3½"
4	12	MA 6421-34

		Arbeitslänge Working length		
Ø mm	Charr./Fr.	90 mm – 3½"	110 mm – 4¼"	130 mm – 5"
1,5	5	MA 6420-05	MA 6420-16	MA 6420-25
2	6	MA 6420-06	MA 6420-17	MA 6420-26
2,3	7	MA 6420-07	MA 6420-18	MA 6420-27
2,5	8	MA 6420-08	MA 6420-19	MA 6420-28
3	9	MA 6420-09	MA 6420-20	MA 6420-29
3,3	10	MA 6420-10	MA 6420-21	MA 6420-30
3,5	11	MA 6420-11	MA 6420-22	MA 6420-31
4	12	MA 6420-12	MA 6420-23	MA 6420-32
5	15	MA 6420-15	MA 6420-24	MA 6420-33

mit Saugunterbrecher und Mandrel
with cut-off and stylet



FRAZIER (FERGUSSON)

		Arbeitslänge Working length	
Ø mm	Charr./Fr.	150 mm – 6"	190 mm – 7½"
1,5	5	MA 6420-34	MA 6420-43
2	6	MA 6420-35	MA 6420-44
2,3	7	MA 6420-36	MA 6420-45
2,5	8	MA 6420-37	MA 6420-46
3	9	MA 6420-38	MA 6420-47
3,3	10	MA 6420-39	MA 6420-48
3,5	11	MA 6420-40	MA 6420-49
4	12	MA 6420-41	MA 6420-50
5	15	MA 6420-42	MA 6420-51

olivenförmig
olive-shaped



FRAZIER

		Arbeitslänge Working length
Ø mm	Charr./Fr.	100 mm – 4"
2	6	MA 6420-56
2,5	8	MA 6420-58
3,3	10	MA 6420-60
4	12	MA 6420-62
5	15	MA 6420-65

Abstandsmarkierungen bei 5 - 9 cm
Calibrations marked at 5 - 9 cm

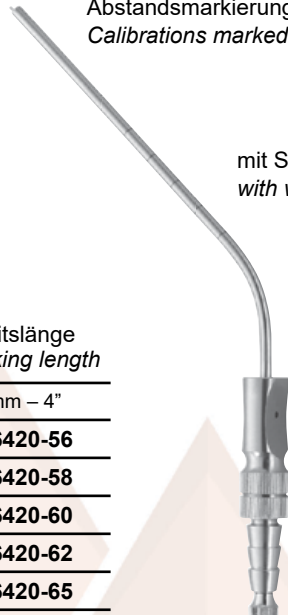

FRAZIER

		Arbeitslänge Working length
Ø mm	Charr./Fr.	100 mm – 4"
2	6	MA 6420-76
2,5	8	MA 6420-78
3,3	10	MA 6420-80
4	12	MA 6420-82
5	15	MA 6420-85

mit Saugunterbrecher und Mandrel
with with cut-off and stylet

mit Saugunterbrecher und Mandrel
with cut-off and stylet

145 mm – 5 3/4"



FERGUSSON

90°
mit Mandrel
with stylet

		Arbeitslänge Working length
Ø mm	Charr./Fr.	100 mm – 4"
2	6	MA 6421-06
2,3	7	MA 6421-07
2,5	8	MA 6421-08
3	9	MA 6421-09
3,3	10	MA 6421-10
3,5	11	MA 6421-11
4	12	MA 6421-12
5	15	MA 6421-15



ADSON

		Arbeitslänge Working length
Ø mm	Charr./Fr.	145 mm – 5 3/4"
4	12	MA 6426-21

M.ASHRAF
INSTRUMENTS

Kanülen Cannulas

mit Langloch Saugunterbrecher und Mandrel
with elongated cut-off and stylet

45°



POPPE

Ø mm	Charr./Fr.	Arbeitslänge Working length	
		90 mm – 3½"	145 mm – 5¾"
2	6	MA 6426-50	MA 6426-60
2,3	7	MA 6426-51	MA 6426-61
2,5	8	MA 6426-52	MA 6426-62
3	9	MA 6426-53	MA 6426-63
3,3	10	MA 6426-54	MA 6426-64
3,5	11	MA 6426-55	MA 6426-65
4	12	MA 6426-56	MA 6426-66
5	15	MA 6426-57	MA 6426-67

Saugrohr, keramikbeschichtet
suction tube, ceramic coated



		Arbeitslänge Working length	
Ø mm	Charr./Fr.	160 mm – 6"	
3	9	MA 6427-100	

		Arbeitslänge Working length	
Ø mm	Charr./Fr.	160 mm – 6"	
3	9	MA 6427-130	

Kanülen Cannulas

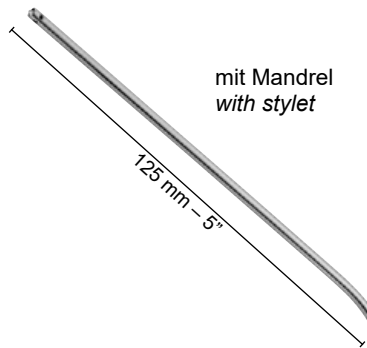

		Arbeitslänge Working length
Ø mm	Charr./Fr.	125 mm - 5"
1,5	5	MA 6427-01
2,3	7	MA 6427-02
3	9	MA 6427-03
4	12	MA 6427-04

MC CULLOCH

mit Mandrel
with stylet



BARON

Olive
Olive
Ø 8 mm

		Arbeitslänge Working length
Ø mm	Charr./Fr.	70 mm - 2¾"
1	3	MA 7845-03
1,5	5	MA 7845-05
2,3	7	MA 7845-07

M.ASHRAF
INSTRUMENTS

Nadelsauger
Suction needle



SCHUKNECHT

Olive
Olive
Ø 8 mm

		Arbeitslänge Working length
Ø mm	Gauges	80 mm - 3¼"
0,9	20	MA 7845-20
0,7	22	MA 7845-22
0,5	24	MA 7845-24



Saug-Raspatorien, Saug-Dissektoren Suction Raspatories, Suction Dissectors

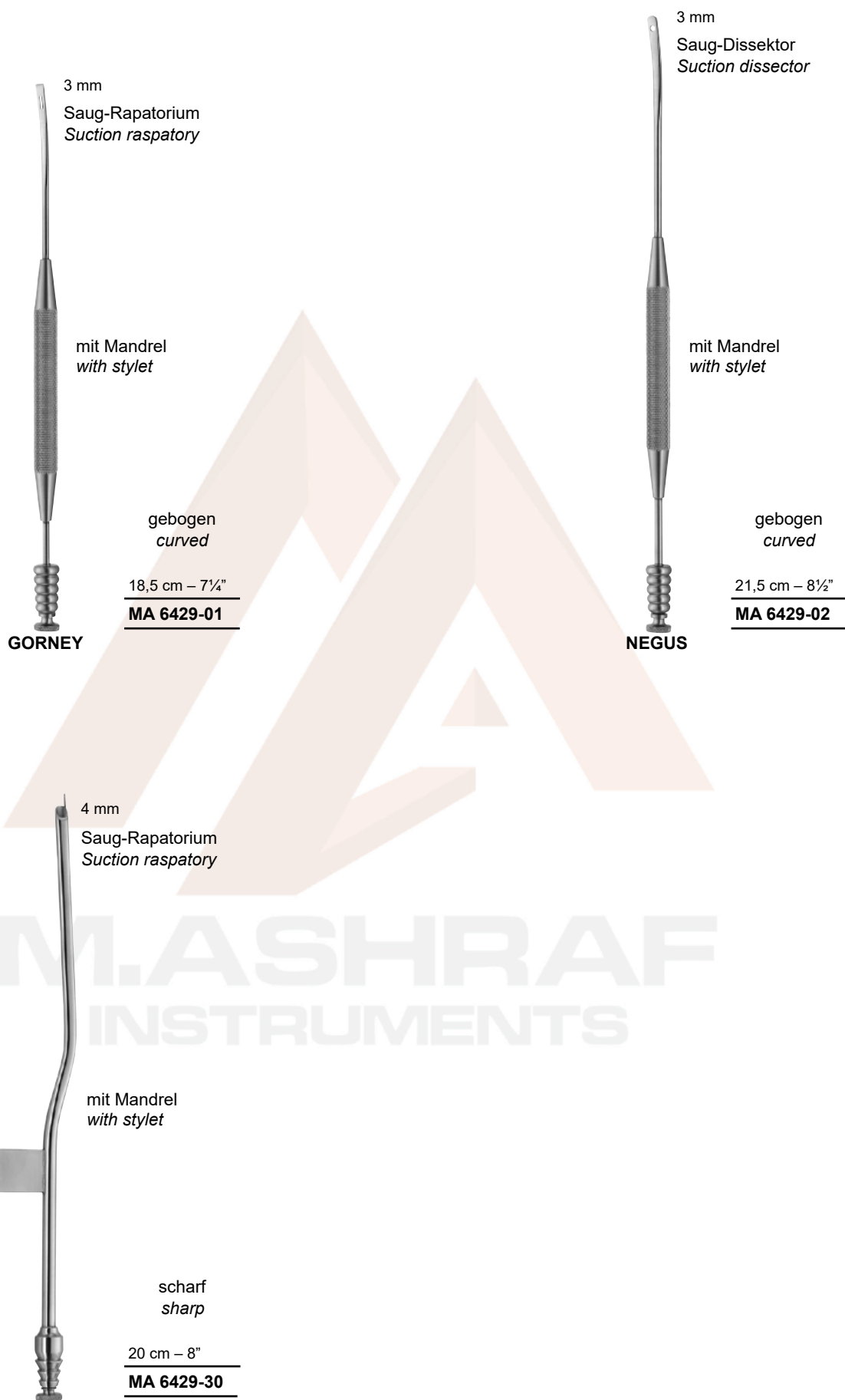

Mikro-Saugkanülen Micro Suction Tubes

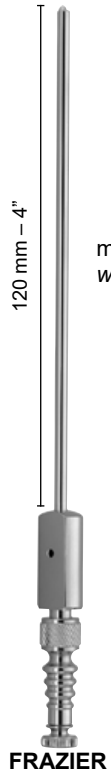

mit Mandrel
with stylet

		Arbeitslänge Working length
Ø mm	Charr./Fr.	120 mm - 4"
2,3	7	MA 6424-20
3	9	MA 6424-21
3,5	11	MA 6424-22

FRAZIER



mit Mandrel
with stylet

		Arbeitslänge Working length
Ø mm	Gauges	140 mm - 5 1/2"
1,62	16	MA 6424-40
1,22	18	MA 6424-41

PRIBRAM

M.ASHRAF
INSTRUMENTS

Katheterzangen Catheter Forceps

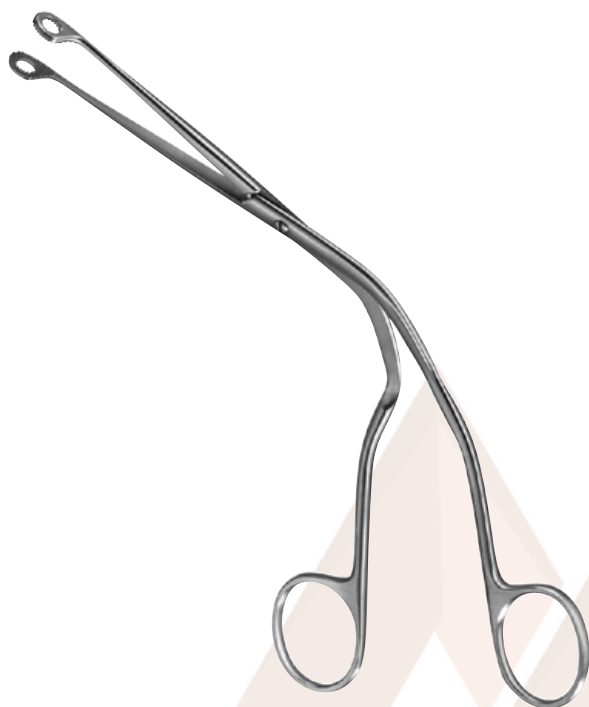

MAGILL



für Kleinkinder
for infants

15 cm – 6"

MA 5295-15



für Kinder
for children

20 cm – 8"

MA 5295-20



für Erwachsene
for adults

25 cm – 10"

MA 5295-25

M.ASHRAF INSTRUMENTS



Luer-Lock Ansatz
Luer Lock connector

mlcc	Dreiring-Spritze 3 ring syringe
2	MA 5285-02
5	MA 5285-05
10	MA 5285-10

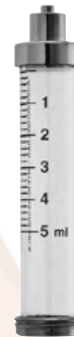

mlcc	Zylinder Cylinder
2	MA 5285-52
5	MA 5285-55
10	MA 5285-60



JANET 1:3

mlcc	Spritze mit 2 Kanülen Syringe with 2 cannulas	Spritze, allein Syringe, only	Zylinder, allein Cylinder, only
50	MA 5286-05	MA 5286-55	MA 5286-75
75	MA 5286-07	MA 5286-57	MA 5286-77
100	MA 5286-10	MA 5286-60	MA 5286-80
150	MA 5286-15	MA 5286-65	MA 5286-85
200	MA 5286-20	MA 5286-70	MA 5286-90

M.ASHRAF
INSTRUMENTS

Luer-Lock Adapter

Luer-Lock Adapter



1:1

LLA weiblich
RC männlich
LLA female
RC male

MA 5288-01



1:1

RC weiblich
LA männlich
RC female
LA male

MA 5288-02



1:1

LLA weiblich
LLA female

MA 5288-21



1:1

LLA männlich
LLA male

MA 5288-03



1:1

LLA weiblich
LLA female

MA 5288-04



1:1

LLA männlich
LLA male

MA 5288-31

M.ASHRAF
INSTRUMENTS



LA = Luer Konus Adapter
LLA = Luer-Lock Adapter
RC = Record Konus Adapter

LA = luer cone adapter
LLA = luer-lock adapter
RC = record conus adapter



Charr. /Fr.	Messerspitze, leicht gebogen <i>Knife tip, slightly curved</i>
8	MA 5291-08
10	MA 5291-10
12	MA 5291-12
14	MA 5291-14
16	MA 5291-16
18	MA 5291-18

REDON



Charr. /Fr.	Messerspitze, gebogen <i>Knife tip, curved</i>
8	MA 5291-28
10	MA 5291-30
12	MA 5291-32
14	MA 5291-34
16	MA 5291-36
18	MA 5291-38

REDON

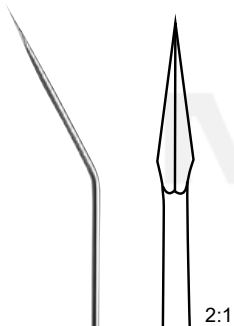

Charr. /Fr.	Lanzettenspitze, leicht gebogen <i>Lancet tip, slightly curved</i>
8	MA 5291-48
10	MA 5291-50
12	MA 5291-52
14	MA 5291-54
16	MA 5291-56
18	MA 5291-58

REDON

M.ASHRAF
INSTRUMENTS

Sonden Probes

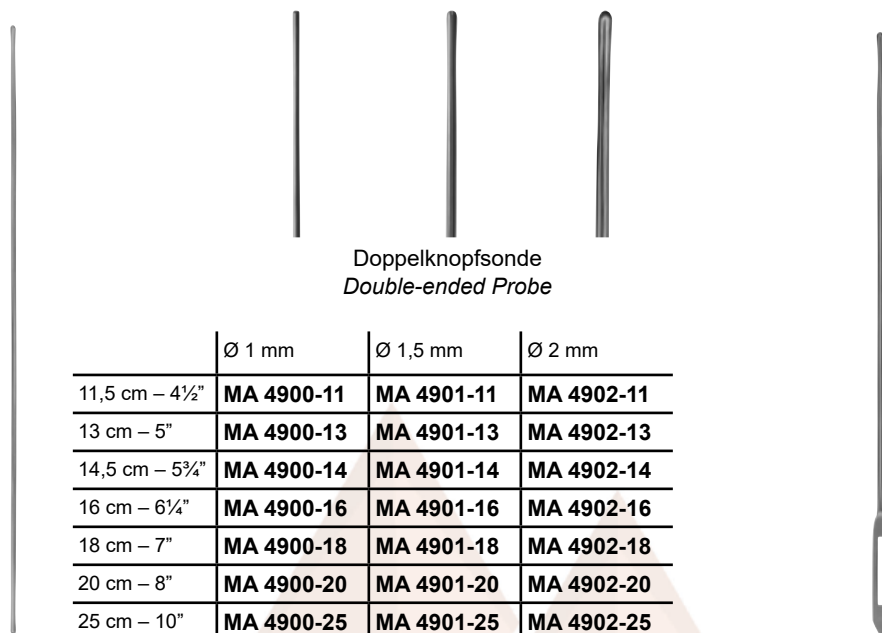

Doppelknopfsonde
Double-ended Probe

	Ø 1 mm	Ø 1,5 mm	Ø 2 mm
11,5 cm – 4½"	MA 4900-11	MA 4901-11	MA 4902-11
13 cm – 5"	MA 4900-13	MA 4901-13	MA 4902-13
14,5 cm – 5¾"	MA 4900-14	MA 4901-14	MA 4902-14
16 cm – 6¼"	MA 4900-16	MA 4901-16	MA 4902-16
18 cm – 7"	MA 4900-18	MA 4901-18	MA 4902-18
20 cm – 8"	MA 4900-20	MA 4901-20	MA 4902-20
25 cm – 10"	MA 4900-25	MA 4901-25	MA 4902-25

	Öhrsonde Probe with eye
11,5 cm – 4½"	MA 4906-11
13 cm – 5"	MA 4906-13
14,5 cm – 5¾"	MA 4906-14
16 cm – 6¼"	MA 4906-16
18 cm – 7"	MA 4906-18
20 cm – 8"	MA 4906-20

M.ASHRAF
INSTRUMENTS



WATSON-CHEYNE

	Sonde Probe
14 cm – 5½"	MA 4907-13
18 cm – 7"	MA 4907-18



FISH

	Sonde Probe
14,5 cm – 5¾"	MA 4908-14
18 cm – 7"	MA 4908-18



	Hohlsonde <i>Director</i>
11,5 cm – 4½"	MA 4910-11
13 cm – 5"	MA 4910-13
14,5 cm – 5¾"	MA 4910-14
16 cm – 6¼"	MA 4910-16
18 cm – 7"	MA 4910-18
20 cm – 8"	MA 4910-20



DOYEN



Sonde, gebogen
Probe, curved

14,5 cm – 5¾"

MA 4911-14



	Hohlsonde <i>Director</i>
13 cm – 5"	MA 4912-13
14,5 cm – 5¾"	MA 4912-14
16 cm – 6¼"	MA 4912-16
18 cm – 7"	MA 4912-18



M.ASHRAF
INSTRUMENTS



Sonde
Probe

14,5 cm – 5¾"

MA 4913-14



Myrtenblattsonde
Myrtle leaf probe

13 cm – 5"

MA 4914-13

14,5 cm – 5¾"

MA 4914-14

16 cm – 6¼"

MA 4914-16

20 cm – 8"

MA 4914-20

Sonden Probes

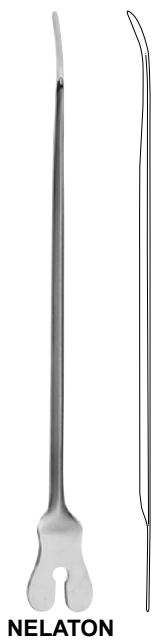

NELATTON

Hohlsonde, gebogen
Director, curved

16 cm – 6¼"

MA 4915-16

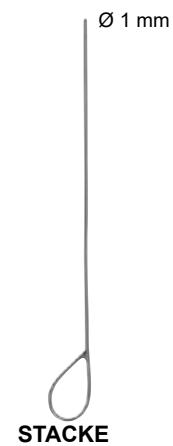

STACKE

Ø 1 mm

Ohrsonde, Silber
Ear probe, silver

10,5 cm – 4¼"

MA 4916-10



BRODIE

Rektal-Hohlsonde
Rectal probe



geknöpfte Spitze
ball end

20 cm – 8"

MA 4917-18



BUIE

Fistelsonde,
biegsam, Silber
*Fistula probe,
malleable, silver*

22,5 cm – 8¾"

MA 4923-16

Fistelsonde
Fistula probe



LOCKART-MUMMARY

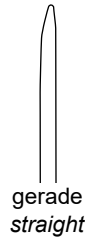

gerade
straight



gebogen 45°
curved 45°

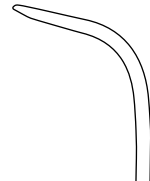

stark gebogen 90°
strongly curved 90°

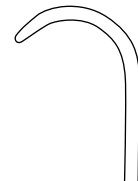

retrograd gebogen
retrograde curved

17 cm – 6¾"

Fig. 1	Fig. 2	Fig. 3	Fig. 4
MA 4925-01	MA 4925-02	MA 4925-03	MA 4925-04

Fistelsonde
Fistula probe



PRATT

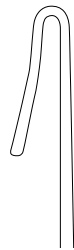

enge Biegung
narrow hook

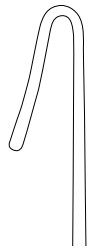

kurzer Haken
short hook

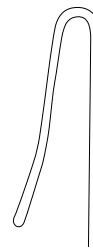

langer Haken
long hook

21 cm – 8¼"

MA 4926-01	MA 4926-02	MA 4926-03
------------	------------	------------

M.ASHRAF
INSTRUMENTS

Watteträger Cotton Applicators

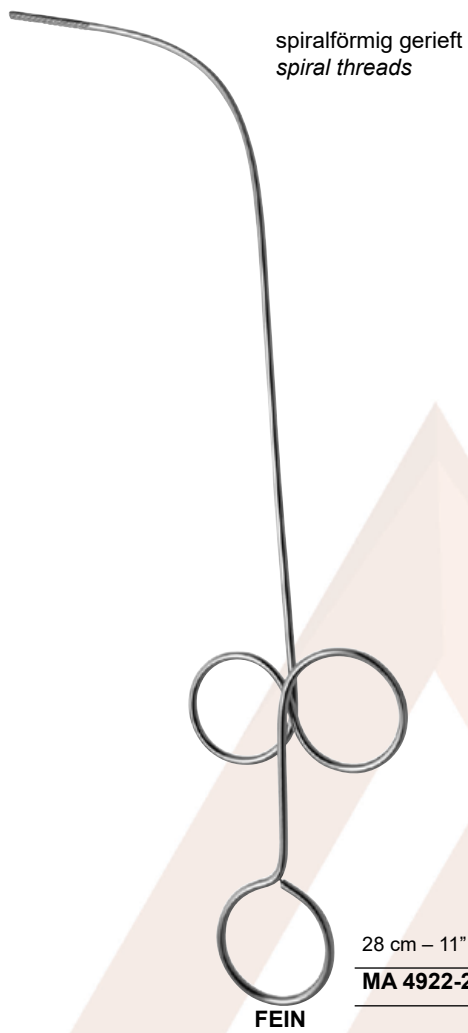

M.ASHRAF
INSTRUMENTS

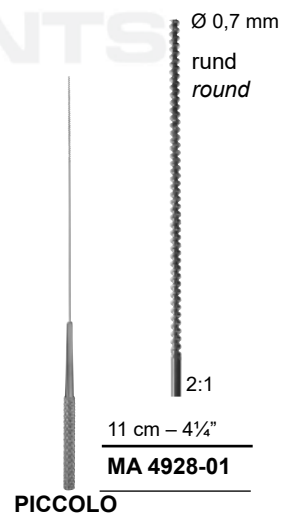
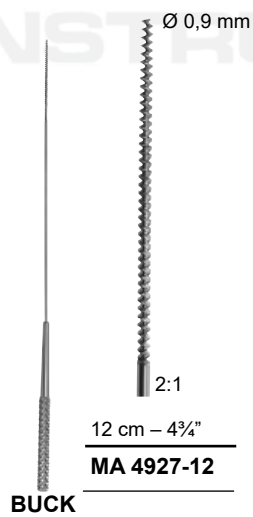

Watteträger Cotton Applicators

Ø 0,7 mm
dreikant
triangular

2:1

11 cm – 4¼"

MA 4928-02

PICCOLO

spiralförmig gerieft
spiral threads

2:1

2:1

Ø 1,3 mm

Ø 1,4 mm

12,5 cm – 5"

MA 4930-12

–

16 cm – 6¼"

MA 4930-16

–

18 cm – 7"

–

MA 4931-18

UNIVERSAL

M.ASHRAF
INSTRUMENTS

doppelendig
double-ended

18 cm – 7"

MA 4933-02

JOBSON-HORNE

Watteträger Cotton Applicators



	Ø mm mm	rund geriefround serrated	dreikant gerieftri- gular serrated
14 cm – 5½"	0,9	MA 4935-14	MA 4936-14
16,5 cm – 6½"	1,1	MA 4935-16	MA 4936-16

FARRELL



	Ø mm mm	spiralför- migspiral threads
12 cm – 4¾"	1 mm	MA 4934-01
14 cm – 5½"	1 mm	MA 4934-02
16 cm – 6¼"	1 mm	MA 4934-03

FROHN

ASHRAF
INSTRUMENTS



1:3



Schaftlänge Shaft length	dreiteiliges Maulwith 3 expanding jaws
28 cm – 11"	MA 4941-28
38 cm – 15"	MA 4941-45

SEVEN



M.ASHRAF
INSTRUMENTS

Wundverschluß

Woundclosure

Nadelhalter-Profil	<i>Needle Holder Tread</i>	WO 1 - 2
Mikro-Nadelhalter	<i>Micro Needle Holders</i>	WO 3 - 9
Nadelhalter	<i>Needle Holders</i>	WO 10 - 37
Unterbindungsnadeln	<i>Ligature Needles</i>	WO 38 - 43
Reverdinnadeln	<i>Reverdin Needles</i>	WO 44 - 45
Führungs-Hohlsonden	<i>Guiding Probes</i>	WO 46 - 50
Wundklammern	<i>Suture Clips</i>	WO 51
Klammeranlegepinzetten	<i>Clip Applying Forceps</i>	WO 52
Chirurgisches Taschenbesteck	<i>Pocket Instrument Set</i>	WO 53
Venae Sectio Besteck	<i>Venae Secito Set</i>	WO 54
Gipsverband- Instrumente	<i>Plaster Cast Instruments</i>	WO 55 - 58

Nadelhalter-Profil Needle Holder Tread

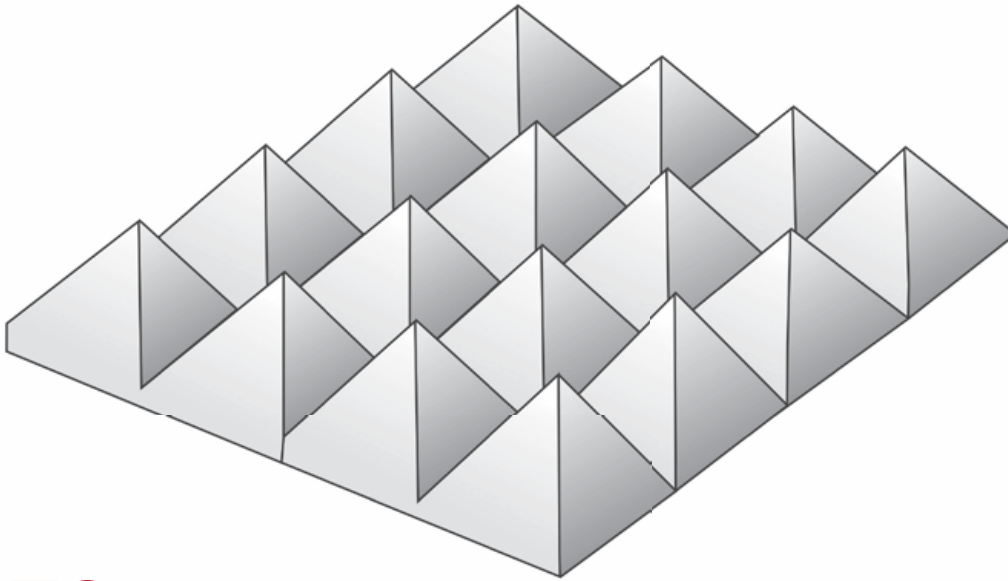

TC

RUDOLF Medical TC Nadelhalter mit diamant-geschliffenem Profil

Für die RUDOLF Medical Nadelhalter werden nur Nadelhalterplatten mit diamant-geschliffenem Pyramidenprofil verwendet.

RUDOLF Medical TC Nadelhalter entsprechen höchsten Ansprüchen:

- präzise Ausführung und hervorragende Qualität
- optimale Abstimmung des Nadelhalters und der TC-Einlage auf den Verwendungszweck
- grazile Nadelhalter für feinste Arbeiten,
- stabile Nadelhalter für größere Nadeln.
- sichere und präzise Sperre, abgestimmt auf die Gesamtstärke des Nadelhalters.

Nur ein diamant-geschliffenes Nadelhalterprofil garantiert:

- die hohe Präzision der eingeschliffenen Pyramidenstruktur
- das homogene, tiefgeschliffene Profil der TC-Platten
- den sicheren Halt der Nadel oder des Nahtmaterials.
- hohe Profil-Formbeständigkeit, Härte und Verschleißfestigkeit.

RUDOLF Medical TC Needle Holders with diamond-cut tread

For the TC needle holders RUDOLF Medical uses only diamond-cut TC inserts with pyramidal tread.

RUDOLF Medical TC Needle Holders meet the highest requirements:

- precise design and excellent quality
- optimal matching of the needle holder and the TC inserts to the application purpose
- slim needle holders for delicate applications,
- solid needle holders for larger needles
- firm and precise ratchet corresponding to the design of the needle holder.

Only a diamond-cut needle holder tread guarantees:

- a high precision of the pyramidal structure of the tread
- homogeneous and deep tread of the TC inserts
- firm holding of the needle or of the suturing material
- high deformation resistance, hardness and wear resistance even of the most delicate tread.

Nadelhalter-Profil

Needle Holder Tread

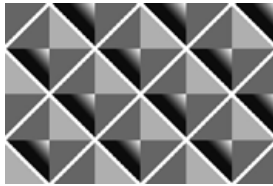

0,5 mm

für Nadeln und Nahtmaterial
bis Stärke 3/0

2500 tpsi (teeth per square inch)
for needles and suturing material
with a thickness of up to 3/0

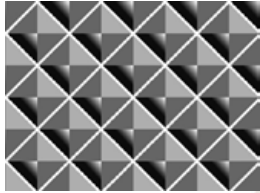

0,4 mm

für feine Nadeln und Nahtmaterial,
Stärke 4/0 – 6/0

3600 tpsi (teeth per square inch) for delicate
needles and suturing material with a thick-
ness of up to 4/0 - 6/0

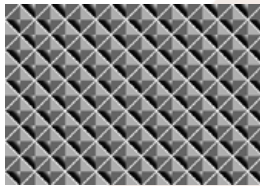

0,3 mm

für feine Nadeln und Nahtmaterial
bis Stärke 8/0

7000 tpsi (teeth per square inch) for
delicate needles and suturing material
with a thickness of up to 8/0

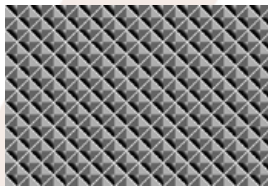

0,2 mm

für feinste Nadeln und Nahtmaterial,
Stärke 6/0 – 10/0

14400 tpsi (teeth per square inch)
for delicate needles and suturing
material, thickness 6/0 – 10/0

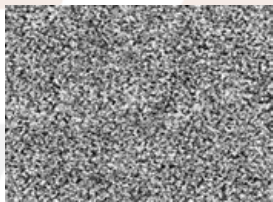

MICROGRIP

für extrem feines Nahtmaterial,
Stärke 6/0 – 11/0

for extremely delicate suturing material,
thickness 6/0 – 11/0



Glatt,

für extrem feines Nahtmaterial,
Stärke 6/0 – 11/0

Smooth,

for extremely delicate suturing material,
thickness 6/0 – 11/0

Mikro-Nadelhalter Micro Needle Holders

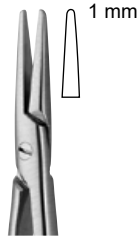

gerade
straight

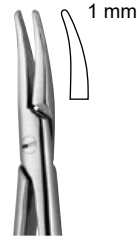

gebogen
curved

	mit Sperre <i>with ratchet</i>	ohne Sperre- <i>without ratchet</i>	mit Sperre <i>with ratchet</i>	ohne Sperre- <i>without ratchet</i>
15 cm – 6"	MA 5852-15	MA 5850-15	MA 5853-15	MA 5851-15

M.ASHRAF
INSTRUMENTS

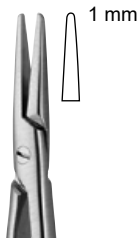

gerade
straight

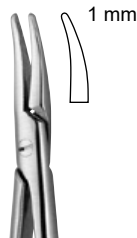

gebogen
curved

	mit Sperre <i>with ratchet</i>	ohne Sperre- <i>without ratchet</i>	mit Sperre <i>with ratchet</i>	ohne Sperre- <i>without ratchet</i>
18 cm – 7"	MA 5852-18	MA 5850-18	MA 5853-18	MA 5851-18

Mikro-Nadelhalter Micro Needle Holders



JACOBSON

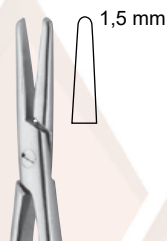

gerade
straight

	mit Sperre with ratchet	ohne Sperre without ratchet
18 cm – 7"	MA 5854-36	MA 5854-39
21 cm – 8¼"	MA 5854-46	MA 5854-49



JACOBSON

Körnung 0,4 mm
Grit 3600 tpsi

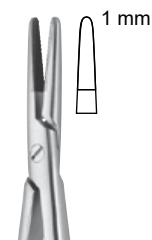

gerade
straight

	Typ Type	mit Sperre with ratchet
18 cm – 7"	TC	MA 5930-32
20 cm – 8"	TC	MA 5930-42
22,5 cm – 8¾"	TC	MA 5930-52

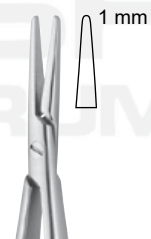

gerade
straight



gebogen
curved

	mit Sperre with ratchet	ohne Sperre without ratchet	mit Sperre with ratchet	ohne Sperre without ratchet
12 cm – 4¾"	MA 5864-12	MA 5860-12	MA 5865-12	MA 5861-12
14,5 cm – 5¾"	MA 5864-15	MA 5860-15	MA 5865-15	MA 5861-15
18 cm – 7"	MA 5864-18	MA 5860-18	MA 5865-18	MA 5861-18
21 cm – 8¼"	MA 5864-21	MA 5860-21	MA 5865-21	MA 5861-21
23 cm – 9"	MA 5864-23	MA 5860-23	MA 5865-23	MA 5861-23

Mikro-Nadelhalter Micro Needle Holders

Evolution / Nano

- leichter als Titan dank neuem Griff-Design
- alle Vorzüge von Edelstahlinstrumenten
- außergewöhnlich gute Haptik für präzises Arbeiten
- problemloses Reinigen für bestmögliche Hygiene
- optimale Ergonomie dank der runden Griffschalen

Evolution / Nano

- lighter than titanium thanks to the new handle design
- all advantages of stainless steel instruments
- unsurpassed haptics for precision during the operation
- easy cleaning for best possible hygiene
- optimal ergonomomy due to the round shell handles



Nano



0,75 mm

geradestraight

15 cm – 6"

MA 5860-75

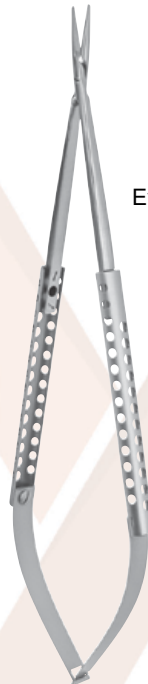

Evolution



gerade
straight



gebogen
curved

12 cm – 4¾"

MA 5860-82

–

15 cm – 6"

MA 5860-85

MA 5861-85

18 cm – 7"

MA 5860-88

MA 5861-88

M.ASHRAF INSTRUMENTS

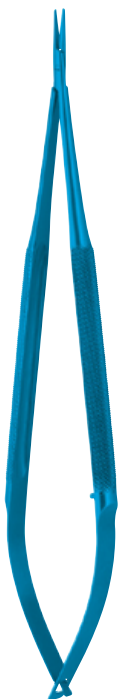

gerade
straight



gebogen
curved



gerade
straight



gebogen
curved

0,4 mm

1 mm

	Typ Type	ohne Sperrewithout ratchet		ohne Sperrewithout ratchet	
14,5 cm – 5¾"	TI	MA 5862-14T	MA 5862-15T	MA 5862-18T	MA 5862-19T
18 cm – 7"	TI	MA 5862-34T	MA 5862-35T	MA 5862-38T	MA 5862-39T
21 cm – 8¼"	TI	MA 5862-44T	MA 5862-45T	MA 5862-48T	MA 5862-49T

Mikro-Nadelhalter Micro Needle Holders

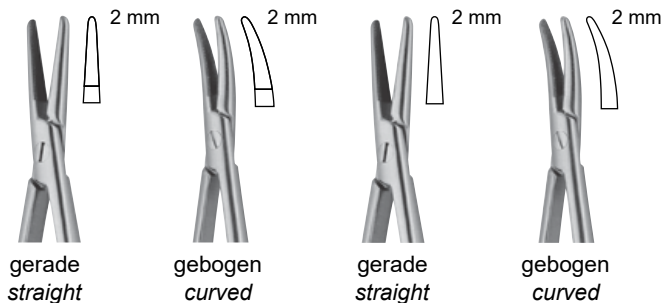

Typ Type	Körnung Grit	mit Sperre with ratchet		mit Sperre with ratchet	
		gerade straight	gebogen curved	glatt smooth	glatt smooth
14 cm – 5½"	TC	MA 5931-12	MA 5931-13	MA 5931-16	MA 5931-17
18 cm – 7"	TC	MA 5931-32	MA 5931-33	MA 5931-36	MA 5931-37
21 cm – 8¼"	TC	MA 5931-42	MA 5931-43	MA 5931-46	MA 5931-47



	Typ Type	mit Sperre with ratchet	ohne Sperre without ratchet	mit Sperre with ratchet	ohne Sperre without ratchet
14,5 cm – 5¾"	TC	MA 5866-12	MA 5866-14	MA 5866-13	MA 5866-15
18 cm – 7"	TC	MA 5866-32	MA 5866-34	MA 5866-33	MA 5866-35
21 cm – 8¼"	TC	MA 5866-42	MA 5866-44	MA 5866-43	MA 5866-45
23 cm – 9"	TC	MA 5866-52	MA 5866-54	MA 5866-53	MA 5866-55

Mikro-Nadelhalter Micro Needle Holders



CASTROVIEJO

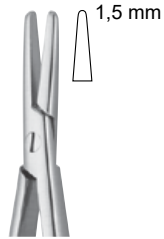

gerade
straight



gebogen
curved

	mit Sperre <i>with ratchet</i>	ohne Sperre <i>without ratchet</i>	mit Sperre <i>with ratchet</i>	ohne Sperre <i>without ratchet</i>
14 cm – 5½"	MA 5952-14	MA 5950-14	MA 5953-14	MA 5951-14



CASTROVIEJO

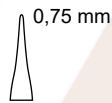

gerade
straight



gebogen
curved

	mit Sperre <i>with ratchet</i>	ohne Sperre <i>without ratchet</i>	mit Sperre <i>with ratchet</i>	ohne Sperre <i>without ratchet</i>
9 cm – 3½"	MA 5958-09	MA 5956-09	MA 5959-09	MA 5957-09



CASTROVIEJO

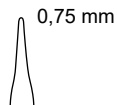

gerade
straight

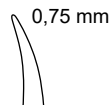

gebogen
curved

	mit Sperre <i>with ratchet</i>	ohne Sperre <i>without ratchet</i>	mit Sperre <i>with ratchet</i>	ohne Sperre <i>without ratchet</i>
14 cm – 5½"	MA 5958-14	MA 5956-14	MA 5959-14	MA 5957-14

M.ASHRAF
INSTRUMENTS

Mikro-Nadelhalter Micro Needle Holders



BARRAQUER-TROUTMAN



gerade
straight



gebogen
curved

	mit Sperre <i>with ratchet</i>	ohne Sperre <i>without ratchet</i>	mit Sperre <i>with ratchet</i>	ohne Sperre <i>without ratchet</i>
10 cm – 4"	MA 5976-10	MA 5974-10	MA 5977-10	MA 5975-10



BARRAQUER



gebogen
curved



gerade
straight



gebogen
curved

	Typ <i>Type</i>	mit Sperre <i>with ratchet</i>	ohne Sperre <i>without ratchet</i>	
11,5 cm – 4½"		MA 5973-17	MA 5970-11	MA 5971-11
	TI	MA 5973-17T	–	MA 5971-11T

M.ASHRAF
INSTRUMENTS



BARRAQUER



gebogen
curved



gerade
straight



gebogen
curved

	Typ <i>Type</i>	mit Sperre <i>with ratchet</i>	ohne Sperre <i>without ratchet</i>	
12 cm – 4¾"		MA 5973-12	MA 5970-12	MA 5971-12
	TI	MA 5973-12T	–	MA 5971-12T

Mikro-Nadelhalter Micro Needle Holders



BARRAQUER

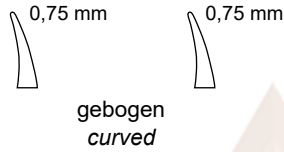

	mit Sperre <i>with ratchet</i>	ohne Sperre <i>without ratchet</i>
13 cm – 5"	MA 5970-02	MA 5970-01



BARRAQUER



	ohne Sperre <i>without ratchet</i>	mit Sperre <i>with ratchet</i>
14 cm – 5½"	MA 5971-14	MA 5973-14

M.ASHRAF
INSTRUMENTS



KALT

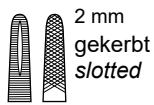

gerade,
mit Sperre
straight, with ratchet

14 cm – 5½"

MA 5986-14



CASTROVIEJO-KALT



gerade,
mit Sperre
straight, with ratchet

13,5 cm – 5½"

MA 5987-14



KALT-ARRUGA

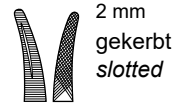

gebogen,
mit Sperre
curved, with ratchet

14 cm – 5½"

MA 5988-14

Nadelhalter Needle Holders



HALSEY

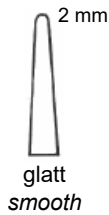
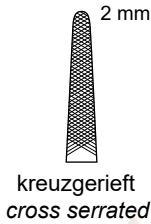

13 cm – 5"

MA 5918-13 | **MA 5918-18**



WEBSTER

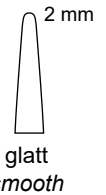

13 cm – 5"

MA 5920-13



DERF



12 cm – 4¾"

MA 5922-12

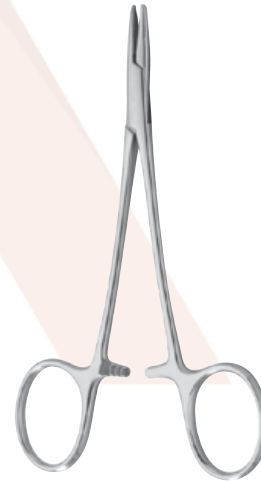

DERF

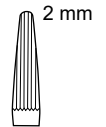

längsgerieft
lengthways serrated

12,5 cm – 5"

MA 5924-12



HEGAR-BAUMGARTNER

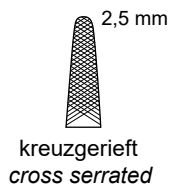

14 cm – 5½"

MA 5927-14



BROWN

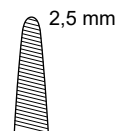

Maul fein gerieft,
Maulteile con-
vexfine serrated
jaws,convex jaws

13 cm – 5"

MA 5928-13

18 cm – 7"

MA 5928-18

Nadelhalter Needle Holders



NEW ORLEANS

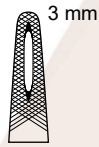

3 mm
gekerbt
slotted

18 cm – 7"

MA 5929-18

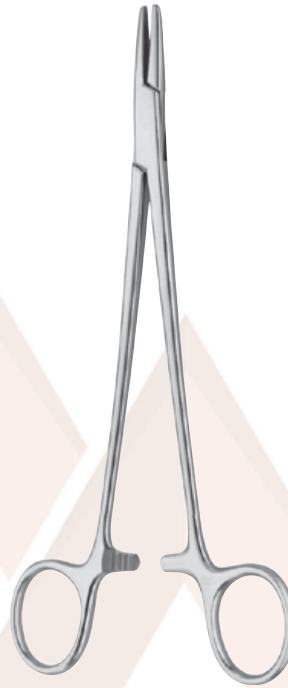

MAYO-HEGAR

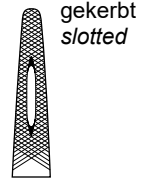

gekerbt
slotted

geradestraight

14 cm – 5½"	MA 6000-14
16 cm – 6¼"	MA 6000-16
18 cm – 7"	MA 6000-18
20 cm – 8"	MA 6000-20
24 cm – 9½"	MA 6000-24
26 cm – 10¼"	MA 6000-26
30 cm – 11¾"	MA 6000-30

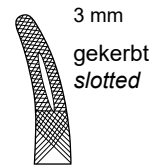

3 mm
gekerbt
slotted

gebogen-
curved

16 cm – 6¼" **MA 6001-16**



HEANEY

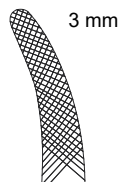

3 mm
gebogen
curved

21 cm – 8¼"

MA 6002-21



MAYO-HEGAR

schlankes Modell
delicate pattern

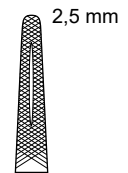

2,5 mm
gekerbt/slotted

16 cm – 6¼"	MA 6003-16
18 cm – 7"	MA 6003-18
20 cm – 8"	MA 6003-20

Nadelhalter Needle Holders



kräftiges Modell
heavy pattern

HEGAR

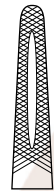

gekerbt
slotted



kreuzgerieft
cross serrated

16 cm – 6¼"	MA 6004-16	–
18 cm – 7"	MA 6004-18	–
20 cm – 8"	MA 6004-20	MA 6004-21



gekerbt
slotted

17 cm – 6¾"
MA 6005-17



gekerbt/slotted

18,5 cm – 7¼"	MA 6006-18
26 cm – 10¼"	MA 6006-26

Nadelhalter Needle Holders

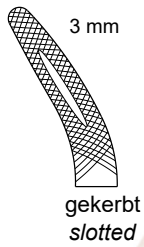

27 cm – 10½"
MA 6007-27

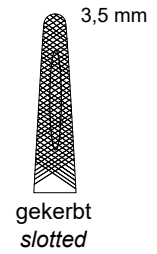
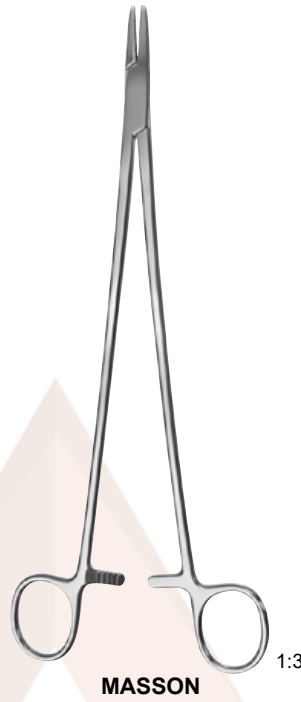

26,5 cm – 10½"
MA 6008-27

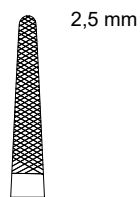
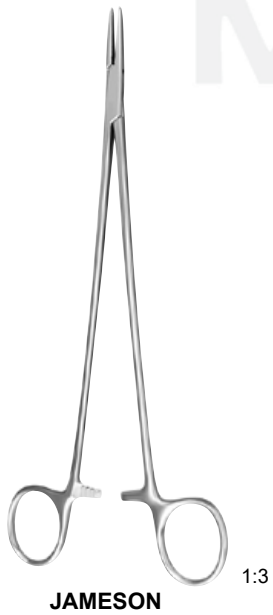

23,5 cm – 9¼"
MA 6009-23

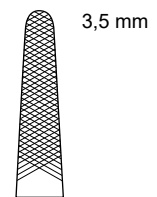

27 cm – 10½"
MA 6010-27

M.ASHRAF
INSTRUMENTS

Nadelhalter Needle Holders



CRILE-WOOD

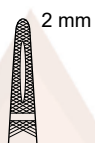

gekerbt
slotted

15 cm – 6"

MA 6012-15



CRILE-MURRAY

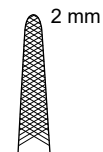

15 cm – 6"

MA 6014-15



ADSON

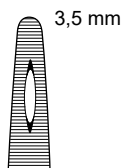

gefenstert
fenestrated

18 cm – 7"

MA 6016-18



SENNING



gekerbt
slotted

17 cm – 6¾"

MA 6017-17

Nadelhalter Needle Holders



BABY-OLSEN-HEGAR

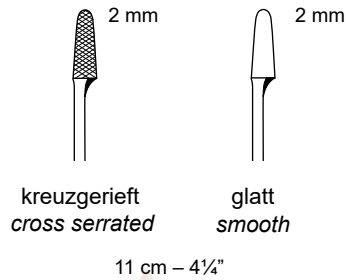

11 cm – 4¼"

MA 6029-11	MA 6029-31
-------------------	-------------------



BABY-OLSEN-HEGAR

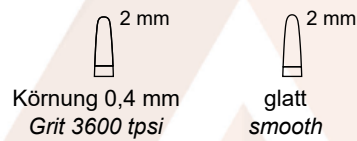

11,5 cm – 4½"

Typ / Type	11,5 cm – 4½"	
TC	MA 6079-11	MA 6079-31



OLSEN-HEGAR

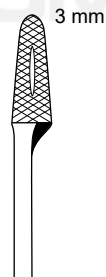

gekerbtslotted

14 cm – 5½"	MA 6030-14
18 cm – 7"	MA 6030-18

M.ASHRAF
INSTRUMENTS

Nadelhalter Needle Holders



OLSEN-HEGAR



kreuzgerieft
cross serrated

17 cm – 6¾"

MA 6030-17



OLSEN-HEGAR

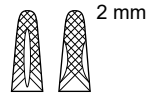

gerade, gekerbt
straight, slotted

14 cm – 5½"

MA 6031-14



OLSEN-HEGAR

Körnung 0,5 mm
Grit 2500 tpsi

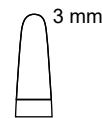
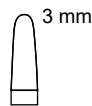

Typ / Type	14 cm – 5½"	17 cm – 6¾"	18,5 cm – 7¼"
TC	MA 6080-14	MA 6080-17	MA 6080-18

Nadelhalter Needle Holders



GILLIES

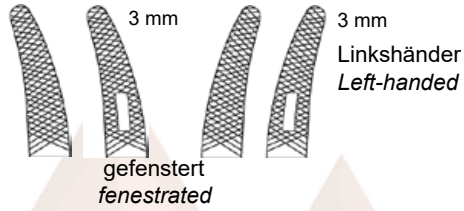
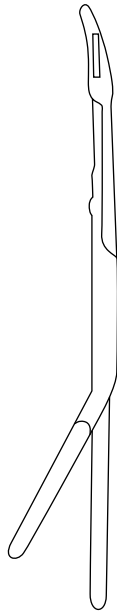

16 cm – 6¼"

MA 6032-16

MA 6032-16L



GILLIES

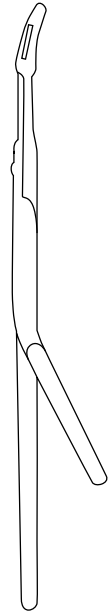

M.ASHRAF
INSTRUMENTS



GILLIES SLIM



gefenstert
fenestrated

15 cm – 6"

MA 6033-14

MA 6033-14L

Nadelhalter Needle Holders



GILLIES SLIM

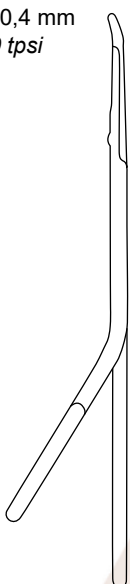

2 mm

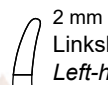

2 mm
Linkshänder
Left-handed

Typ / Type	15,5 cm – 6"	
TC	MA 6081-14	MA 6081-14L

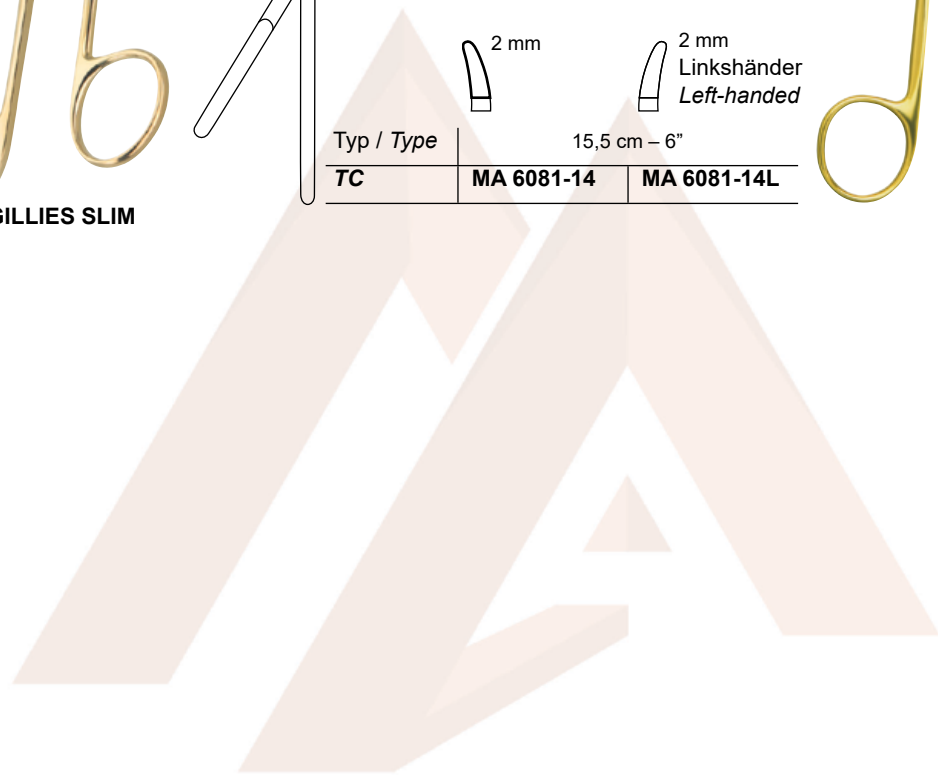
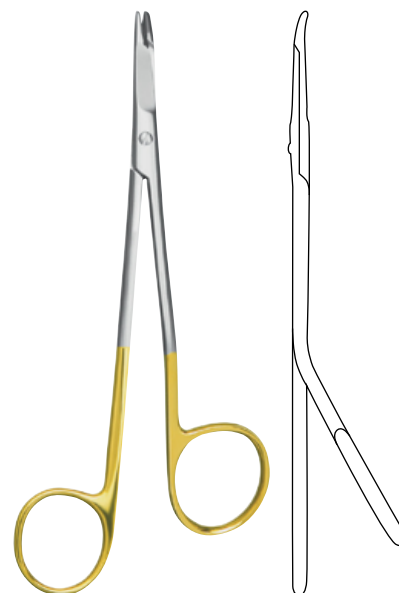

GILLIES



Körnung 0,5 mm
Grit 2500 tpsi

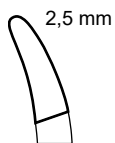

2,5 mm



2,5 mm
Linkshänder
Left-handed

Typ / Type	16 cm – 6¼"	
TC	MA 6081-16	MA 6081-16L



Nadelhalter Needle Holders

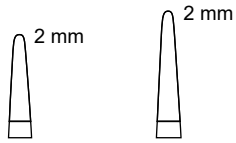

Typ / Type	11,5 cm – 4½"	13,5 cm – 5¼"
TC	MA 6044-01	MA 6044-03

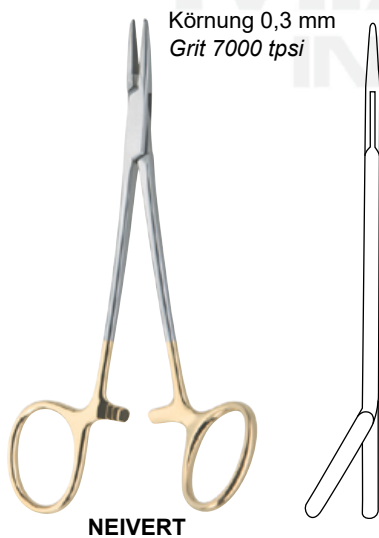

Typ / Type	13 cm – 5"	
TC	MA 6044-13	MA 6044-13L

Nadelhalter Needle Holders

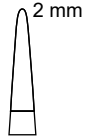

Typ / Type	13 cm – 5"
TC	MA 6045-13

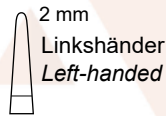
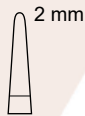

glatt
smooth

Typ / Type	13 cm – 5"	
TC	MA 6046-13	MA 6046-13L

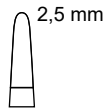

Typ / Type	12,5 cm – 5"
TC	MA 6047-12



Körnung 0,4 mm
Grit 3600 tpsi

NEW ORLEANS

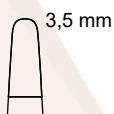

Typ / Type	18 cm – 7"
TC	MA 6048-18

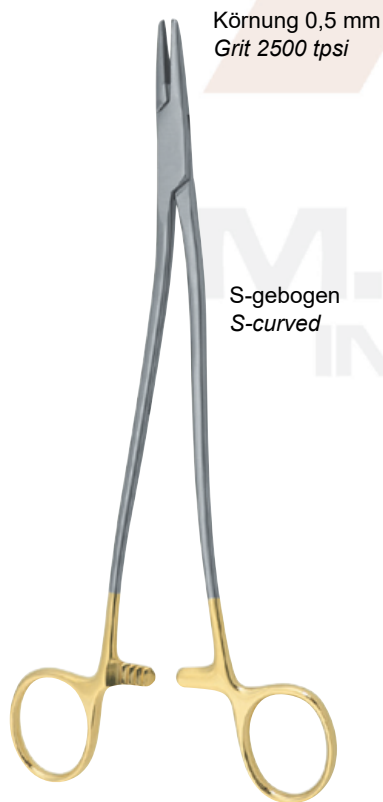

Körnung 0,5 mm
Grit 2500 tpsi

S-gebogen
S-curved

BOZEMANN

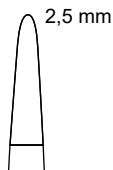

Typ / Type		
TC	20 cm – 8"	MA 6049-20
TC	24 cm – 9½"	MA 6049-24
TC	26 cm – 10¼"	MA 6049-26

M.ASHRAF
INSTRUMENTS

Nadelhalter Needle Holders

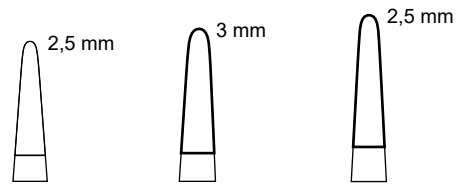

Typ / Type	16 cm – 6¼"	18 cm – 7"	20 cm – 8"
TC	MA 6050-16	MA 6050-18	MA 6050-20

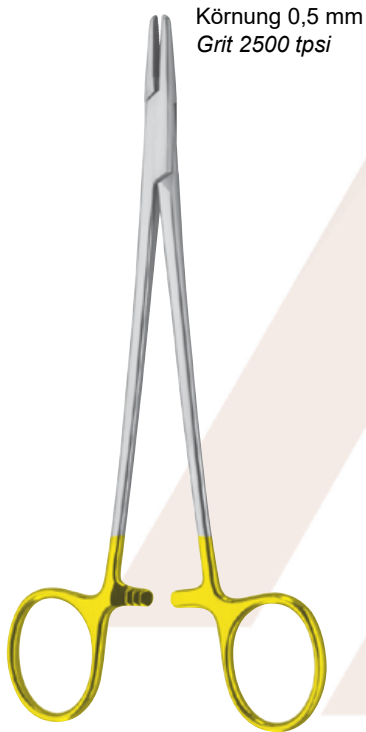

Körnung 0,5 mm
Grit 2500 tpsi

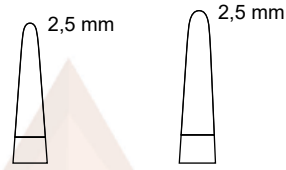

Linkshänder
Left-handed

Typ / Type	16 cm – 6¼"	18 cm – 7"
TC	MA 6050-16L	MA 6050-18L

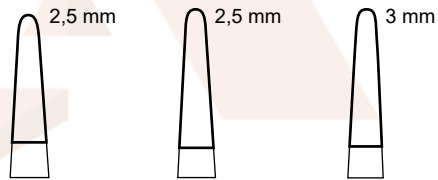

Typ / Type	24 cm – 9½"	26 cm – 10¼"	30 cm – 11¼"
TC	MA 6050-24	MA 6050-26	MA 6050-30

MAYO-HEGAR

M.ASHRAF
INSTRUMENTS

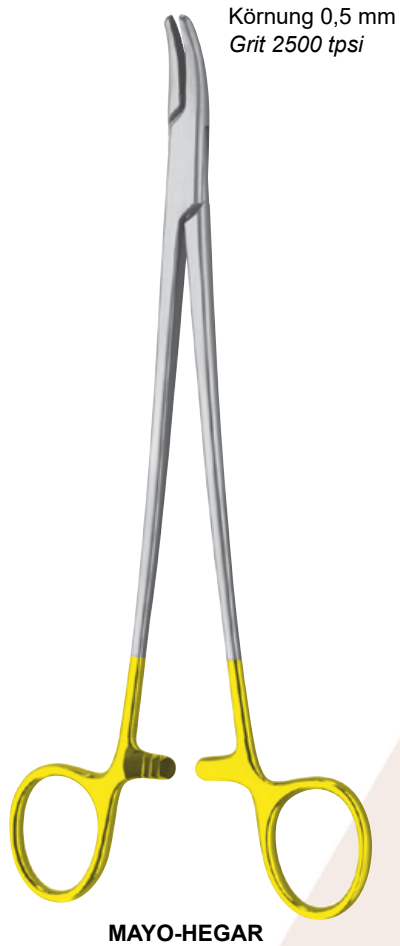

Typ / Type	20 cm – 8"	24 cm – 9½"	26 cm – 10¼"
TC	MA 6051-20	MA 6051-24	MA 6051-26

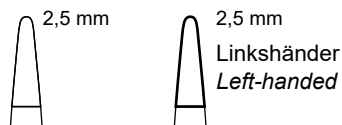

Typ / Type	14 cm – 5½"	
TC	MA 6052-14	MA 6052-14L

MASHRAF
INSTRUMENTS

Nadelhalter Needle Holders

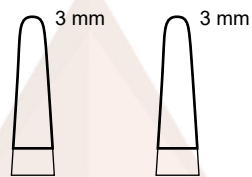
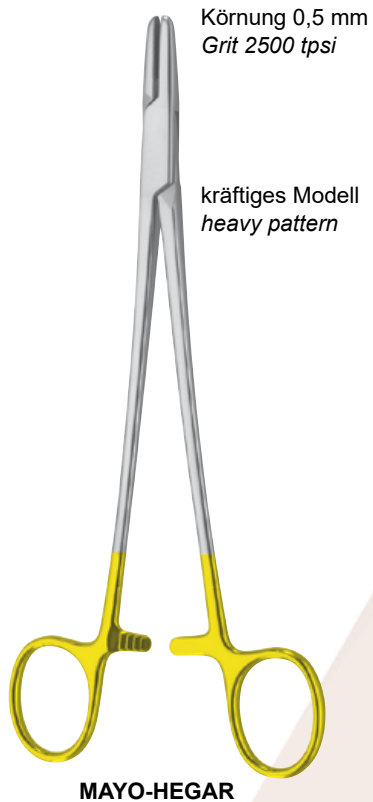

Typ / Type	20 cm – 8"	24 cm – 9½"
TC	MA 6053-20	MA 6053-24

M.ASHRAF
INSTRUMENTS

Nadelhalter Needle Holders

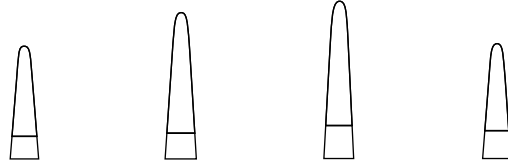

Typ / Type	16 cm – 6¼"	18 cm – 7"	20 cm – 8"	21 cm – 8¼"
TC	MA 6054-40	MA 6054-18	MA 6054-20	MA 6054-41



Typ / Type	23 cm – 9"	26,5 cm – 10½"	30,5 cm – 12"
TC	MA 6054-23	MA 6054-26	MA 6054-31



Typ / Type	18 cm – 7"	
TC	MA 6054-68	MA 6054-68L

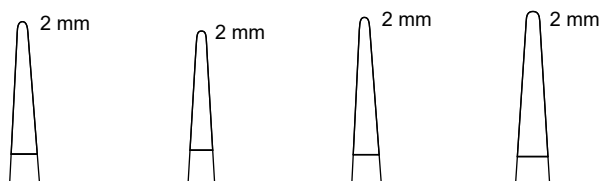

Typ / Type	20 cm – 8"	23 cm – 9"	26,5 cm – 10½"	30,5 cm – 12"
TC	MA 6054-70	MA 6054-73	MA 6054-76	MA 6054-81

Nadelhalter Needle Holders

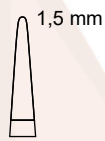

15 cm – 6"

MA 6055-01

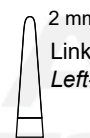

Typ / Type

15 cm – 6"

TC

MA 6055-15

MA 6055-15L

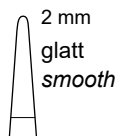

Typ / Type

15 cm – 6"

TC

MA 6055-35

Nadelhalter Needle Holders

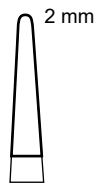

Typ / Type	18 cm – 7"	
TC	MA 6055-18	MA 6055-18L

Typ / Type	20 cm – 8"	23 cm – 9"	26 cm – 10¼"	31 cm – 12¼"
TC	MA 6055-20	MA 6055-23	MA 6055-26	MA 6055-31



Typ / Type	18 cm – 7"
TC	MA 6055-48



Typ / Type	20 cm – 8"
TC	MA 6055-50

Nadelhalter Needle Holders



Typ / Type	23 cm – 9"
TC	MA 6055-53

M.ASHRAF
INSTRUMENTS

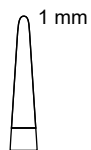

Typ / Type	13 cm – 5"
TC	MA 6056-13
TI	MA 6056-13T

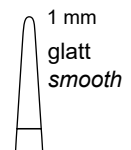

Typ / Type	13 cm – 5"
TC	MA 6056-33

Nadelhalter Needle Holders



CONVERSE

Typ / Type	12,5 cm – 5"
TC	MA 6057-12

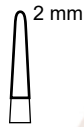

KILNER

Typ / Type	13,5 cm – 5¼"
TC	MA 6058-13

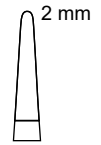

HEGAR-VASCULAR



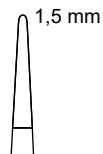

	Typ Type	geradestraight
14 cm – 5½"	TC	MA 6059-39
18 cm – 7"	TC	MA 6059-40
20 cm – 8"	TC	MA 6059-41
23 cm – 9"	TC	MA 6059-42





M.ASHRAF
INSTRUMENTS



Nadelhalter Needle Holders





	 2 mm	 2 mm	 2 mm	 2 mm
Typ / Type	14 cm – 5½"	18 cm – 7"	20 cm – 8"	22 cm – 8¾"
TC	MA 6059-29	MA 6059-30	MA 6059-31	MA 6059-32

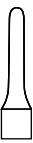

			 Linkshänder Left-handed
Typ / Type	13 cm – 5"	15 cm – 6"	
TC	MA 6059-13	MA 6059-16	MA 6059-16L

		 Linkshänder Left-handed
Typ / Type	18 cm – 7"	
TC	MA 6059-18	MA 6059-18L

			
Typ / Type	20 cm – 8"	23 cm – 9"	25 cm – 10"
TC	MA 6059-20	MA 6059-23	MA 6059-26

Nadelhalter Needle Holders



Körnung 0,2 mm
Grit 14400 tpsi

MICRO-RYDER

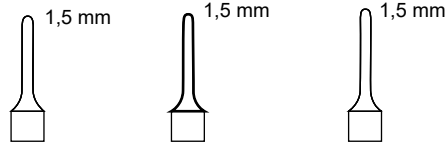

Typ / Type	13 cm – 5"	15 cm – 6"	18 cm – 7"
TC	MA 6059-63	MA 6059-65	MA 6059-68

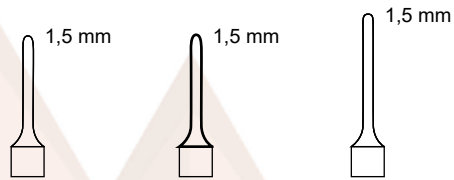

Typ / Type	20 cm – 8"	23 cm – 9"	26 cm – 10¼"
TC	MA 6059-70	MA 6059-73	MA 6059-76



Körnung 0,3 mm
Grit 7000 tpsi

RUDOLF (SWEDISH PATTERN)

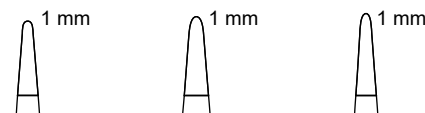

Typ / Type	15 cm – 6"	17 cm – 6¾"	20 cm – 8"
TC	MA 6060-01	MA 6060-02	MA 6060-03

M.ASHRAF
INSTRUMENTS

Nadelhalter Needle Holders

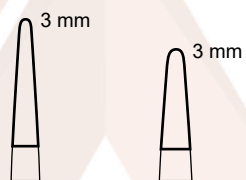

Typ / Type	18 cm – 7"	26 cm – 10¼"
TC	MA 6060-18	MA 6060-26

M.ASHRAF
INSTRUMENTS

Körnung 0,4 mm
Grit 3600 tpsi

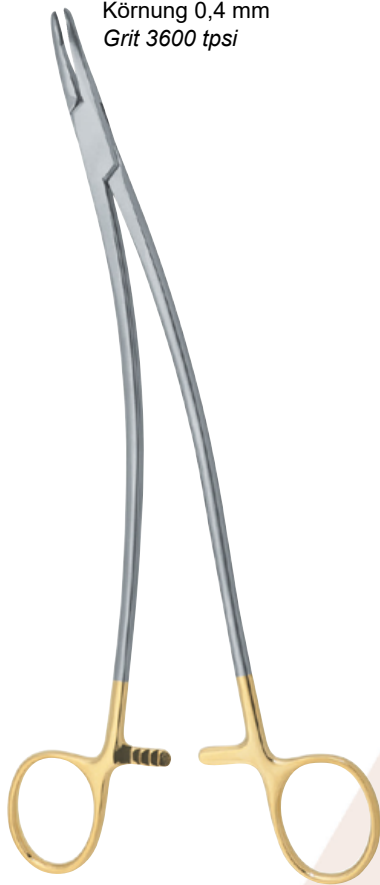

STRATTE



Typ / Type	23 cm – 9"
TC	MA 6061-23

Körnung 0,5 mm
Grit 2500 tpsi



MASSON

1:3

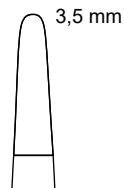

Typ / Type	27 cm – 10½"
TC	MA 6062-27

M.ASHRAF
INSTRUMENTS

Nadelhalter Needle Holders



Typ / Type	27 cm – 10½"
TC	MA 6063-27

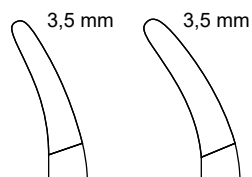

Typ / Type	20 cm – 8"	27 cm – 10½"
TC	MA 6064-20	MA 6064-27

Nadelhalter Needle Holders

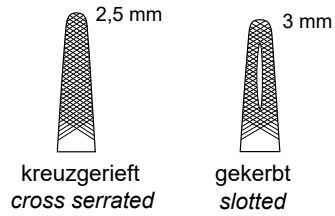

14 cm – 5½"	MA 6040-14	MA 6042-14
17 cm – 6¾"	MA 6040-17	MA 6042-17
20 cm – 8"	MA 6040-20	MA 6042-20

Körnung 0,4 mm
Grit 3600 tpsi

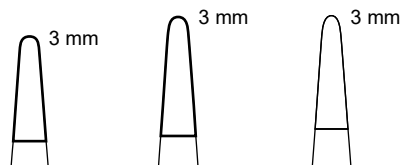

Typ / Type	14 cm – 5½"	17 cm – 6¾"	20 cm – 8"
TC	MA 6065-14	MA 6065-17	MA 6065-20

M.ASHRAF
INSTRUMENTS



Nadelhalter Needle Holders



Körnung 0,5 mm
Grit 2500 tpsi

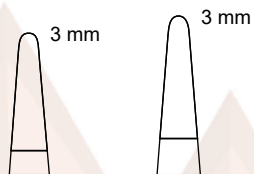

Typ / Type	17 cm – 6¾"	20 cm – 8"
TC	MA 6066-17	MA 6066-20

MATHIEU



Körnung 0,5 mm
Grit 2500 tpsi

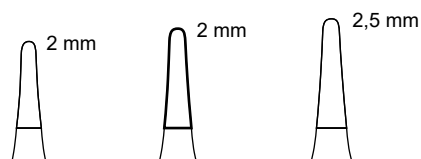

Typ / Type	14 cm – 5½"	17 cm – 6¾"	20 cm – 8"
TC	MA 6070-14	MA 6070-17	MA 6070-20

MATHIEU-KOHLER



Körnung 0,5 mm
Grit 2500 tpsi

schweres Modell,
mit Innensperre
*heavy pattern,
with special ratchet*

MATHIEU

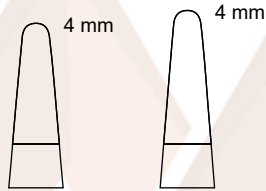

Typ / Type	20 cm – 8"	24 cm – 9½"
TC	MA 6072-20	MA 6072-24



Körnung 0,5 mm
Grit 2500 tpsi

MATHIEU-METZENBAUM

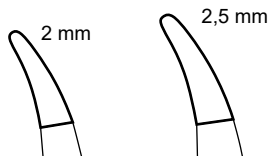

Typ / Type	17 cm – 6¾"	20 cm – 8"
TC	MA 6073-17	MA 6073-20

M.ASHRAF
INSTRUMENTS

Unterbindungsnadeln Ligature Needles

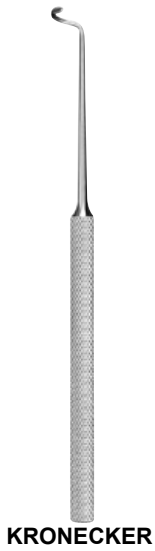

rechts
right

13 cm – 5"

MA 6118-15

KRONECKER

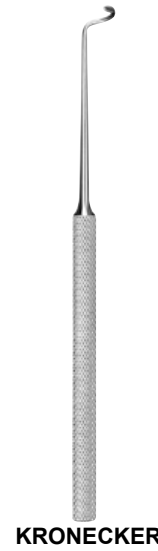

links
left

13 cm – 5"

MA 6119-15

KRONECKER



rechts
right

links
left

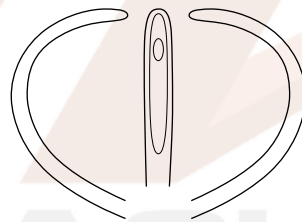

rechts, stumpf
right, blunt links, stumpf
left, blunt

20 cm – 8"

MA 6100-20

MA 6102-20

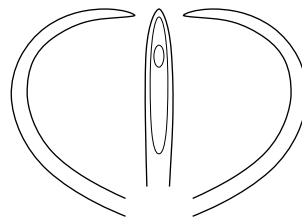

rechts, scharf
right, sharp links, scharf
left, sharp

20 cm – 8"

MA 6104-20

MA 6106-20

DESCHAMPS-STANDARD



rechts
right

links
left

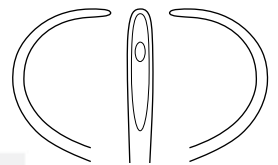

rechts, stumpf
right, blunt links, stumpf
left, blunt

20 cm – 8"

MA 6108-01

MA 6108-02

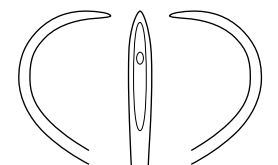

rechts, scharf
right, sharp links, scharf
left, sharp

20 cm – 8"

MA 6108-03

MA 6108-04

DESCHAMPS-STANDARD

Unterbindungsnadeln Ligature Needles

rechts
right



links
left



DESCHAMPS

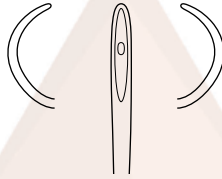

rechts, stumpf, steile Biegung
right, blunt, steep turn

links, stumpf, steile Biegung
left, blunt, steep turn

22,5 cm – 8¾"

MA 6105-01	MA 6105-02
------------	------------

rechts
right



links
left



DESCHAMPS

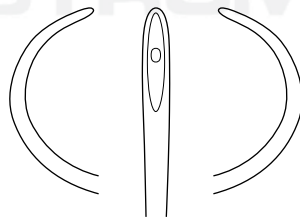

rechts, stumpf, steile Biegung
right, blunt, steep turn

links, stumpf, steile Biegung
left, blunt, steep turn

22,5 cm – 8¾"

MA 6105-03	MA 6105-04
------------	------------

M.ASHRAF
INSTRUMENTS

Unterbindungsnadeln Ligature Needles

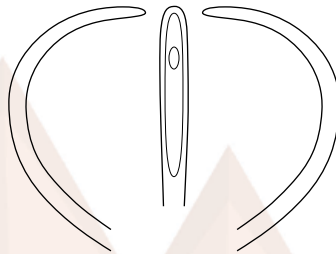
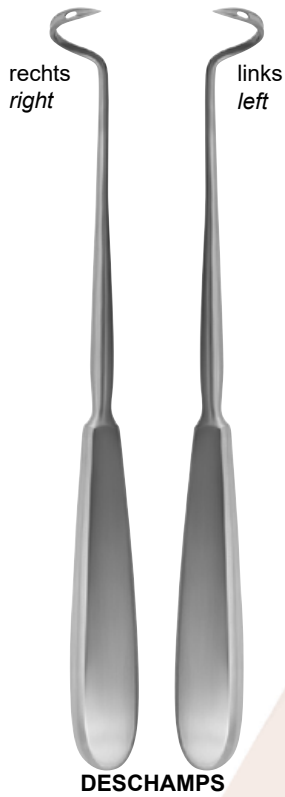

rechts, stumpf links, stumpf
right, blunt left, blunt

21 cm – 8¼"

MA 6110-21	MA 6112-21
-------------------	-------------------

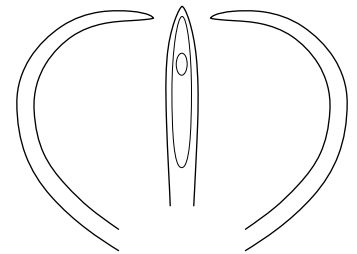

rechts, scharf links, scharf
right, sharp left, sharp

21 cm – 8¼"

MA 6114-21	MA 6116-21
-------------------	-------------------

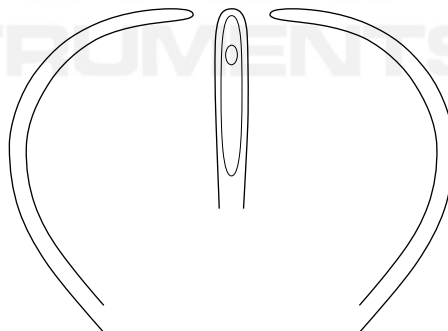

rechts, stumpf links, stumpf
right, blunt left, blunt

24 cm – 9½"

MA 6110-24	MA 6112-24
-------------------	-------------------

Unterbindungsnadeln Ligature Needles

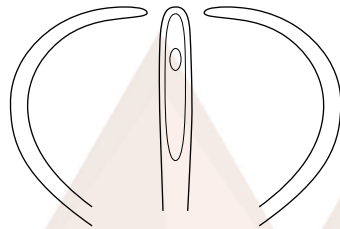

rechts, stumpf
right, blunt

links, stumpf
left, blunt

27 cm – 10½"

MA 6110-27

MA 6112-27

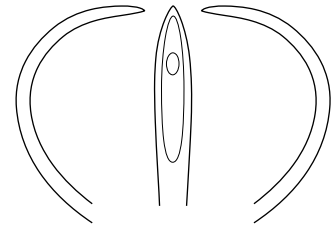

rechts, scharf
right, sharp

links, scharf
left, sharp

27 cm – 10½"

MA 6114-27

MA 6116-27

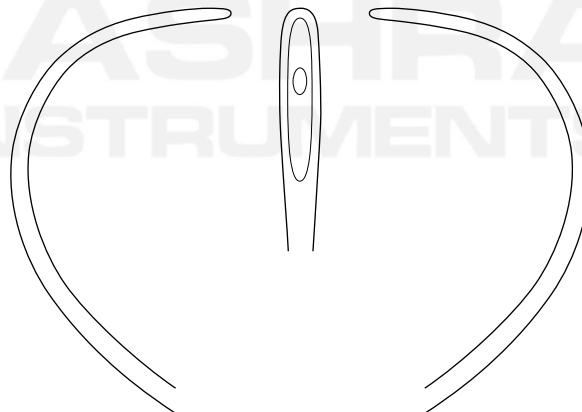

rechts, stumpf
right, blunt

links, stumpf
left, blunt

28 cm – 11"

MA 6110-28

MA 6112-28

Unterbindungsnadeln Ligature Needles

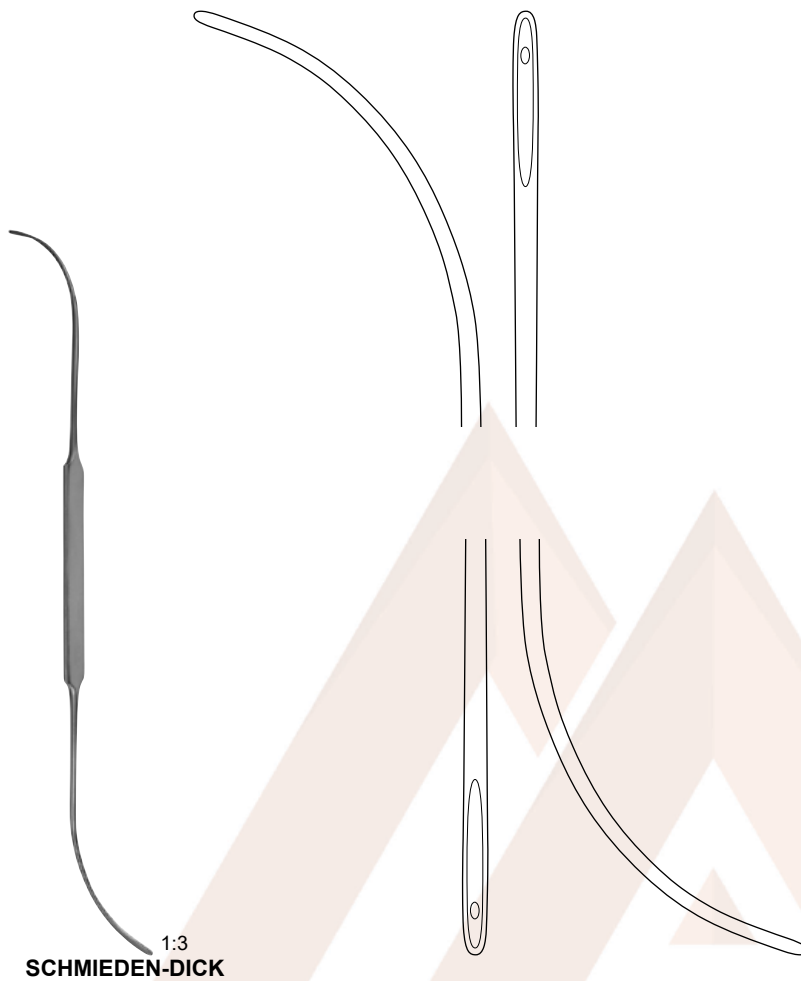

biegsam
malleable

30 cm – 11¾"

MA 6121-01

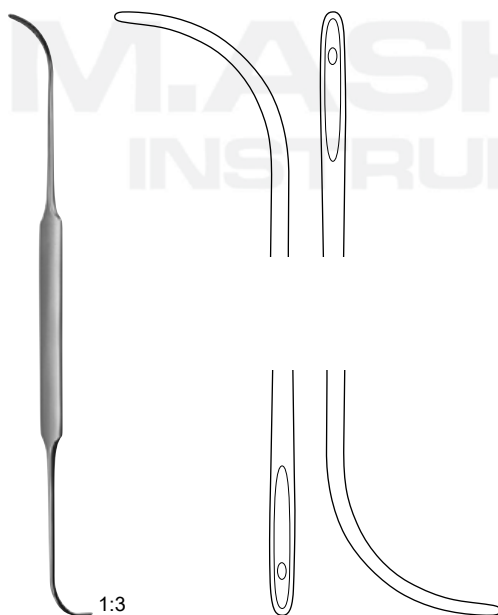

für die linke Hand
for left hand

24 cm – 9½"

MA 6121-21

Unterbindungsnadeln
Ligature Needles



biegsam
malleable

21 cm – 8¼"

MA 6123-20



18,5 cm – 7¼"

MA 6124-19

COOPER

M.ASHRAF
INSTRUMENTS

Reverdin Nadeln Reverdin Needles



REVERDIN



Fig. 1



Fig. 2



Fig. 3



Fig. 4

14,5 cm – 5¾"

MA 6126-01	MA 6126-02	MA 6126-03	MA 6126-04
------------	------------	------------	------------



REVERDIN



Fig. 1



Fig. 2



Fig. 3



Fig. 4

19,5 cm – 7¾"

MA 6127-01	MA 6127-02	MA 6127-03	MA 6127-04
------------	------------	------------	------------

Reverdin Nadeln Reverdin Needles



Fig. 1



Fig. 2

22,5 cm – 8¾"

MA 6128-01

MA 6128-02



REVERDIN



Fig. 3



Fig. 4

22,5 cm – 8¾"

MA 6128-03

MA 6128-04

M.ASHRAF
INSTRUMENTS

Führungs-Hohlsonden Guiding Probes



PAYR

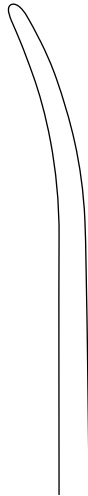

gebogen
curved

19,5 cm – 7¾"

MA 6131-19



PAYR



gerade
straight

22 cm – 8¾"

MA 6130-22



PAYR



gebogen
curved

22 cm – 8¾"

MA 6131-22

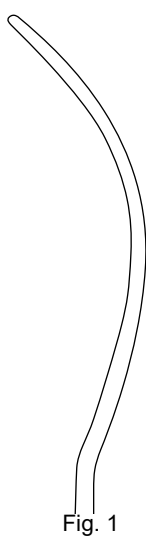

30 cm – 11¾"

MA 6132-01



MA 6132-02

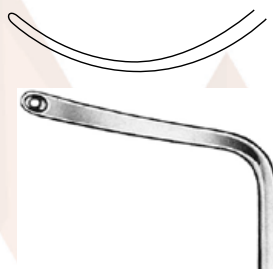

30 cm – 11¾"

MA 6132-03

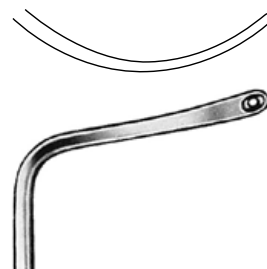

MA 6132-04

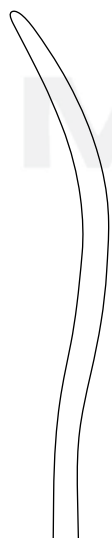

30 cm – 11¾"

MA 6133-01

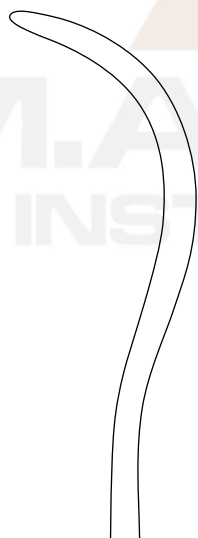

MA 6133-02



30 cm – 11¾"

MA 6133-03



MA 6133-04

Führungs-Hohlsonden Guiding Probes



KIRSCHNER



25,5 cm – 10"

MA 6134-25



BRUNNER

Aus Kunststoff-Hartgewebe
sterilisierbar im Autoklav

*Of plastic material,
can be sterilised in an
autoclave*



18 cm – 7"

MA 6136-18

25 cm – 10"

MA 6136-24

27 cm – 10½"

MA 6136-27

M.ASHRAF INSTRUMENTS

Führungs-Hohlsonden Guiding Probes



19 cm – 7½"

MA 6139-19

SCHMIEDEN-PAYR



19 cm – 7½"

MA 6140-19

SCHMIEDEN



19,5 cm – 7¾"

MA 6141-19

KÖNIG



19,5 cm – 7¾"

MA 6142-19

KÖNIG



Führungs-Hohlsonden Guiding Probes



KÖNIG



20 cm – 8"

MA 6143-20



Fadenfänger
Suture hook

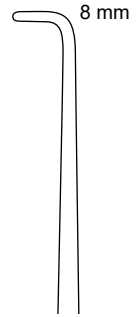

8 mm

23,5 cm – 9 1/4"

MA 6145-23

1:3
**MODELL WIEN
VIENNA PATTERN**



Fadengabel
Knottier



23 cm – 9"

MA 6147-23

Wundklammern Suture Clips



Klammeranlege- und
Entfernungszange
*Clip applying and
removing forceps*

12 cm – 4¾"
MA 6150-12

MICHEL

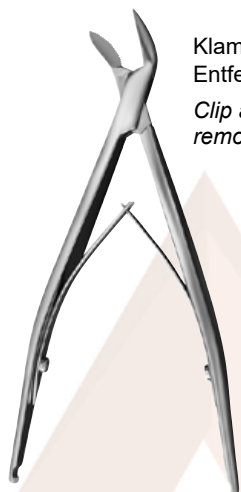

Klammeranlege- und
Entfernungszange
*Clip applying and
removing forceps*

12,5 cm – 5"
MA 6151-12

MICHEL



Klammeranlege- und
Entfernungszange
*Clip applying and
removing forceps*

13 cm – 5"
MA 6152-13

COLLIN

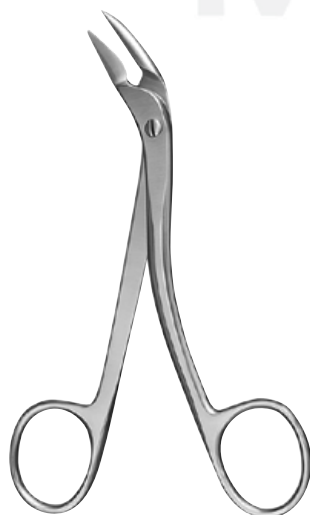

RICHTER-HEATH

14 cm – 5½"
MA 6153-14

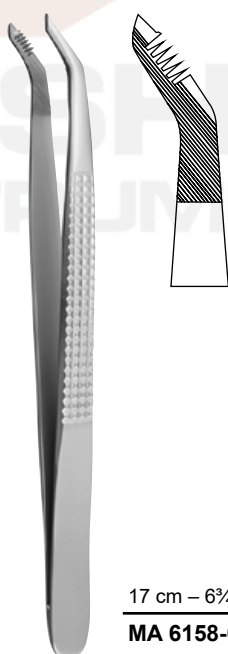

CHILD

17 cm – 6¾"
MA 6158-01

M.ASHRAF
INSTRUMENTS

Klammeranlegepinzetten Clip Applying Forceps



MICHEL

12 cm – 4¾"

MA 6164-12



WACHENFELDT

12 cm – 4¾"

MA 6165-12



HEGENBARTH

12,5 cm – 5"

MA 6168-12

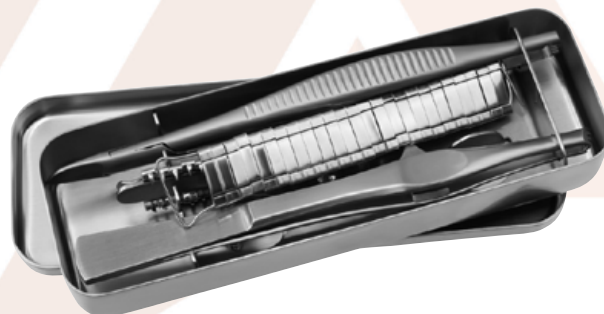

MICHEL

Wundklammerbesteck komplett, bestehend aus:
Suture clip set complete, consisting of:

MA 6170-00

- 1 Wundklammerzange (MA 6150-12)
- 1 *Clip applying forceps (MA 6150-12)*
- 1 Wundrand-Fasspinzette mit Klammerhalter (MA 6165-01)
- 1 *Wound grasping forceps with clip holder (MA 6165-01)*
- 50 Wundklammern
- 50 *Suture clips*

Chirurgisches Taschenbesteck Pocket Instrument Set

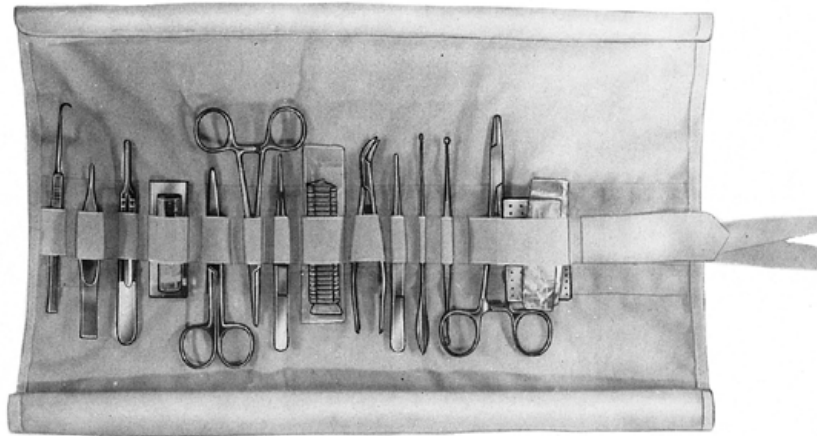

Chirurgisches Taschenbesteck komplett, bestehend aus:
Pocket instrument set complete, consisting of:

MA 6180-00

- 1 Arterienklemme Crile, 14 cm - 5½", gerade (MA 3074-14)
- 1 *Hemostatic forceps, 14 cm - 5½", straight (MA 3074-14)*
- 1 Häkchen Bergmann, 14 cm - 5½", scharf (MA 4469-14)
- 1 *Hook Bergmann, 14 cm - 5½", sharp (MA 4469-14)*
- 1 Skalpellgriff No. 4, 13,5 cm - 5¼" (MA 4850-04)
- 1 *Scalpel handle No. 4, 13.5 cm - 5¼" (MA 4850-04)*
- 1 Myrtenblattsonde, 13 cm - 5" (MA 4914-13)
- 1 *Myrtle blade probe, 13 cm - 5" (MA 4914-13)*
- 1 Doppellöffel Williger, 13,5 cm - 5¼", Ø 4,2 / 3,5 mm, scharf (MA 5368-12)
- 1 *Double curette Williger, 13.5 cm - 5¼", Ø 4.2 / 3.5 mm, sharp (MA 5368-12)*
- 1 Nadelhalter Mayo-Hegar, 16 cm - 6¼", gerade (MA 6000-16)
- 1 *Needle holder Mayo-Hegar, 16 cm - 6¼", straight (MA 6000-16)*
- 1 Nadeldose gelocht, 50 x 25 x 4,5 mm (MA 8910-50)
- 1 *Needle case perforated, 50 x 25 x 4.5 mm (MA 8910-50)*
- 1 Nadeldose gelocht, 75 x 25 x 4,5 mm (MA 8910-75)
- 1 *Needle case perforated, 75 x 25 x 4.5 mm (MA 8910-75)*
- 1 Chirurgische Schere, 13 cm - 5", spitz / stumpf, gerade (MA 1002-13)
- 1 *Surgical scissors, 13 cm - 5", sharp / blunt, straight (MA 1002-13)*
- 1 Anatomische Pinzette Standard, 13 cm - 5", gerade (MA 4000-13)
- 1 *Dressing forceps Standard, 13 cm - 5", straight (MA 4000-13)*
- 1 Chirurgische Pinzette Standard, 13 cm - 5", 1 : 2 Zähne, gerade (MA 4100-13)
- 1 *Tissue forceps Standard, 13 cm - 5", 1 : 2 teeth, straight (MA 4100-13)*
- 1 Splitterpinzette Feilchenfeld, 11,5 cm - 4½", gerade (MA 4320-11)
- 1 *Splinter forceps Feilchenfeld, 11.5 cm - 4½", straight (MA 4320-11)*
- 1 Wundklammerzängchen Michel modif., 12,5 cm - 5" (MA 6151-12)
- 1 *Clip applying forceps Michel modif., 12,5 cm - 5" (MA 6151-12)*
- 1 Rolltasche allein, im Autoklav sterilisierbar (MA 6180-00/01)
- 1 *Pocket bag, only, autoclavable (MA 6180-00/01)*
- 1 Metalletui allein (MA 8979-00)
- 1 *Metal case, only, (MA 8979-00)*

Venae Sectio Besteck

Venae Sectio Set

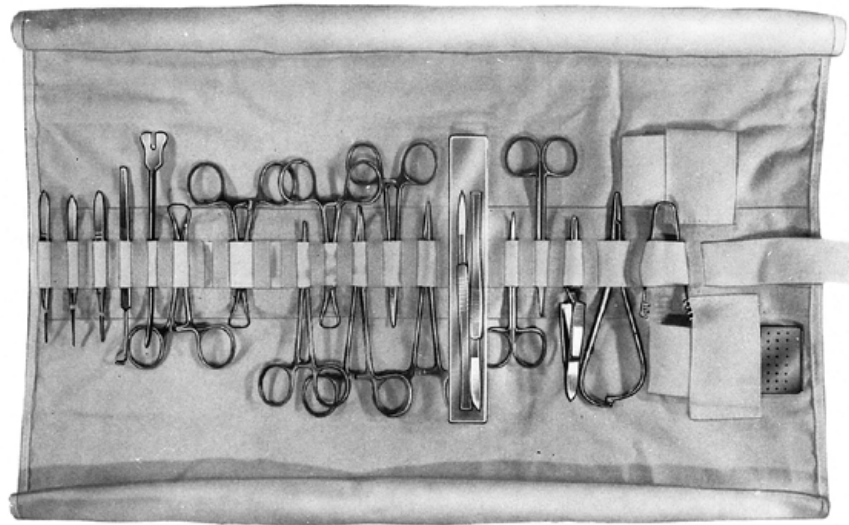

Venae Sectio Besteck komplett, bestehend aus:
Venae sectio set complete, consisting of:

MA 6185-00

- 1 Schere, 10,5 cm - 4¼", fein, gebogen (MA 1631-10)
- 1 Scissors, 10.5 cm - 4¼", delicate, curved (MA 1631-10)
- 1 Gefässschere mit Knopf, 11,5 cm - 4½", gerade (MA 1705-11)
- 1 Coronary scissors with ball-end, 11.5 cm - 4½", straight (MA 1705-11)
- 1 Anatomische Pinzette, 10 cm - 4", fein, gerade (MA 4250-10)
- 1 Dressing forceps, 10 cm - 4", delicate, straight (MA 4250-10)
- 1 Chirurgische Pinzette, 10,5 cm - 4¼", fein, gerade, 1 : 2 Zähne (MA 4260-10)
- 1 Tissue forceps, 10.5 cm - 4¼", delicate, straight, 1 : 2 teeth (MA 4260-10)
- 1 Wundsperrer Finsen, 7 cm - 2¾", feststellbar, scharf (MA 4642-07)
- 1 Retractor Finsen, 7 cm - 2¾", lockable, sharp (MA 4642-07)
- 1 Hohlsonde Doyen, 14,5 cm - 5¾", gebogen (MA 4911-14)
- 1 Probe Doyen, 14.5 cm - 5¾", curved (MA 4911-14)
- 1 Nadelhalter Mathieu, 14 cm - 5½", gerade (MA 6040-14)
- 1 Needle holder Mathieu, 14 cm - 5½", straight (MA 6040-14)
- 1 Unterbindungsnadel Kronecker, 13 cm - 5", links (MA 6118-15)
- 1 Ligation needle Kronecker, 13 cm - 5", left (MA 6118-15)
- 1 Klammeranlagezange Hegenbarth, 12,5 cm - 5", 2 : 3 Zähne (MA 6168-12)
- 1 Clip applying forceps Hegenbarth, 12.5 cm - 5", 2 : 3 teeth (MA 6168-12)
- 1 Chirurgische Pinzette Micro-Adson-Bierner, 12 cm - 4¾", fein, gerade, 1 : 2 Zähne (MA 4131-12)
- 1 Tissue forceps Micro-Adson-Bierner, 12 cm - 4¾", delicate, straight, 1 : 2 teeth (MA 4131-12)
- 2 Arterienklemme Halstead-Mosquito, 12,5 cm - 5", gebogen (MA 3101-12)
- 2 Hemostatic forceps Halstead-Mosquito, 12.5 cm - 5", gebogen (MA 3101-12)
- 2 Arterienklemme Halstead-Mosquito, 12,5 cm - 5", gerade, 1 : 2 Zähne (MA 3110-12)
- 2 Hemostatic forceps Halstead-Mosquito, 12.5 cm - 5", straight, 1 : 2 teeth (MA 3110-12)
- 3 Tuchklemme Backhaus, 9 cm - 3½" (MA 3600-09)
- 3 Towel forceps Backhaus, 9 cm - 3½" (MA 3600-09)
- 1 Anatomisches Skalpell, Fig. 1, spitz (MA 4858-01)
- 1 Dissecting Scalpel, Fig. 1, pointed (MA 4858-01)
- 1 Anatomisches Skalpell, Fig. 6, spitz (MA 4858-06)
- 1 Dissecting Scalpel, Fig. 6, pointed (MA 4858-06)
- 1 Nadeldose gelocht, 50 x 25 x 4,5 mm (MA 8910-50)
- 1 Needle case perforated, 50 x 25 x 4.5 mm (MA 8910-50)
- 1 Rolltasche allein, im Autoklav sterilisierbar (MA 6180-00/01)
- 1 Pocket bag, only, autoclavable (MA 6180-00/01)
- 1 Metalletui allein (MA 8979-00)
- 1 Metal case, only, (MA 8979-00)

Gipsverband-Instrumente Plaster cast instruments



Gipsmesser
Plaster knives

20 cm – 8”

MA 6210-20

HOPKINS



Gipsmesser
Plaster knives

18 cm – 7”

MA 6212-18

ESMARCH



Gipsmesser
Plaster knives

18,5 cm – 7¼”

MA 6214-18

REINER

M.ASHRAF
INSTRUMENTS



Gipssäge
Plaster saw

15 cm – 6”

MA 6225-14

ENGEL



Gipsspreizer
Plaster spreader

28 cm – 11”

MA 6230-28

HENNING

1:3

Gipsverband-Instrumente Plaster cast instruments



Gipspreizer
Plaster spreader

23 cm – 9”

MA 6234-23

1:3

**MODELL USA
USA PATTERN**



Gipsabreißzange
Plaster breaker

18 cm – 7”

MA 6240-18

24 cm – 9½”

MA 6240-24

WOLFF



Gipsschere
Plaster shears

STILLE

24 cm – 9½”

MA 2835-24

1:3



Gipsschere
Plaster shears

Messer mit verstärktem Rücken
Blade with reinforced back

23 cm – 9”

MA 2840-23

26 cm – 10¼”

MA 2840-26

37 cm – 14½”

MA 2840-37

STILLE

1:3

Gipsverband-Instrumente Plaster cast instruments

Gipssägen mit oszillierenden Sägeblättern
Plaster saws with oscillating saw blades



inkl. Sägeblätter
incl. saw blades
MA 6220-83
MA 6220-85

Standard
Standard

MA 6220-20



inkl. Sägeblätter
incl. saw blades
MA 6220-83
MA 6220-85

Akku
Accu

MA 6220-22



inkl. Sägeblätter
incl. saw blades
MA 6220-84
MA 6220-85

ECO-Version
ECO Version

MA 6220-24

Zubehör für MA 6220-22 Accessories for MA 6220-22



Akku (1700 mAh)
für oszillierender Gipssäge (MA 6220-22)
*Battery, rechargeable, (1700 mAh) for
oscillating plaster saw (MA 6220-22)*

MA 6220-41



Schnell-Ladegerät für Akku
(MA 6220-41)
*Quick recharger for accu
(MA 6220-41)*

MA 6220-42

Zubehör Accessories

Koffer für oszillierende Gipssägen (MA 6220-20 Standard, MA 6220-24 ECO-Version) <i>Case for oscillating plaster saws (MA 6220-20 Standard, MA 6220-24 ECO-Version)</i>	MA 6220-31
Koffer für oszillierende Gipssäge (MA 6220-22 ACCU) <i>Case for oscillating plaster saw (MA 6220-22 ACCU)</i>	MA 6220-32

Gipsverband-Instrumente Plaster cast instruments

Sägeblätter (autoklavierbar)
Material: rostfreier Edelstahl
Saw blades (autoclavable)
Material: stainless steel

Rundsägeblatt
Round saw blade



	Gips Plaster	Synthetik Syntetic
Ø 44 mm	MA 6220-80	MA 6220-81
Ø 50 mm	MA 6220-82	MA 6220-83
Ø 65 mm	MA 6220-84	MA 6220-85



Segment-Sägeblatt
Segment saw blade

	Gips Plaster	Synthetik Syntetic
Ø 65 mm	MA 6220-86	MA 6220-87



Taillen-Sägeblatt
Wasted saw blade

	Gips Plaster	Synthetik Syntetic
Ø 65 mm	MA 6220-88	MA 6220-89



Tiefensägeblatt
Deep saw blade

	Gips Plaster	Synthetik Syntetic
Ø 70 mm	MA 6220-91	MA 6220-92



Gipssäge, komplett mit Staubsauger, bestehend aus:
Plaster saw, complete with vacuum cleaner consisting of:

MA 6220-51

- 1 Gipssäge, oszillierend (MA 6220-20 inkl. MA 6220-83 und MA 6220-85)
- 1 Plaster saw, oscillating (MA 6220-20 incl. MA 6220-83 and MA 6220-85)
- 1 Sauger (MA 6220-60)
- 1 Vacuum cleaner (MA 6220-60)
- 1 Schlauch (RZ6220-62)
- 1 Tube (RZ6220-62)
- 1 Schlauchhalter (RZ6220-70)
- 1 Hose clamp (RZ6220-70)
- 1 Absaugglocke (RZ6220-68)
- 1 Dust removal unit (RZ6220-68)
- 1 Adapterkabel (RZ6220-73)
- 1 Adaptercable (RZ6220-73)
- 1 Werkzeug (RZ6220-71)
- 1 Tool (RZ6220-71)

Staubsauger ohne Zubehör
Vacuum cleaner without accessories

MA 6220-60

Optional:

- Aufhängung mit Griff, höhenverstellbar (RZ6220-69), nur für MA 6220-20 und MA 6220-22 geeignet - Magnetische Ablage (RZ6220-72)

Optional:

- Hanging kit with handle, height adjustable (RZ6220-69), suitable only for MA 6220-20 and 6220-22 - Magnetic placement (RZ6220-72)

EIGHT

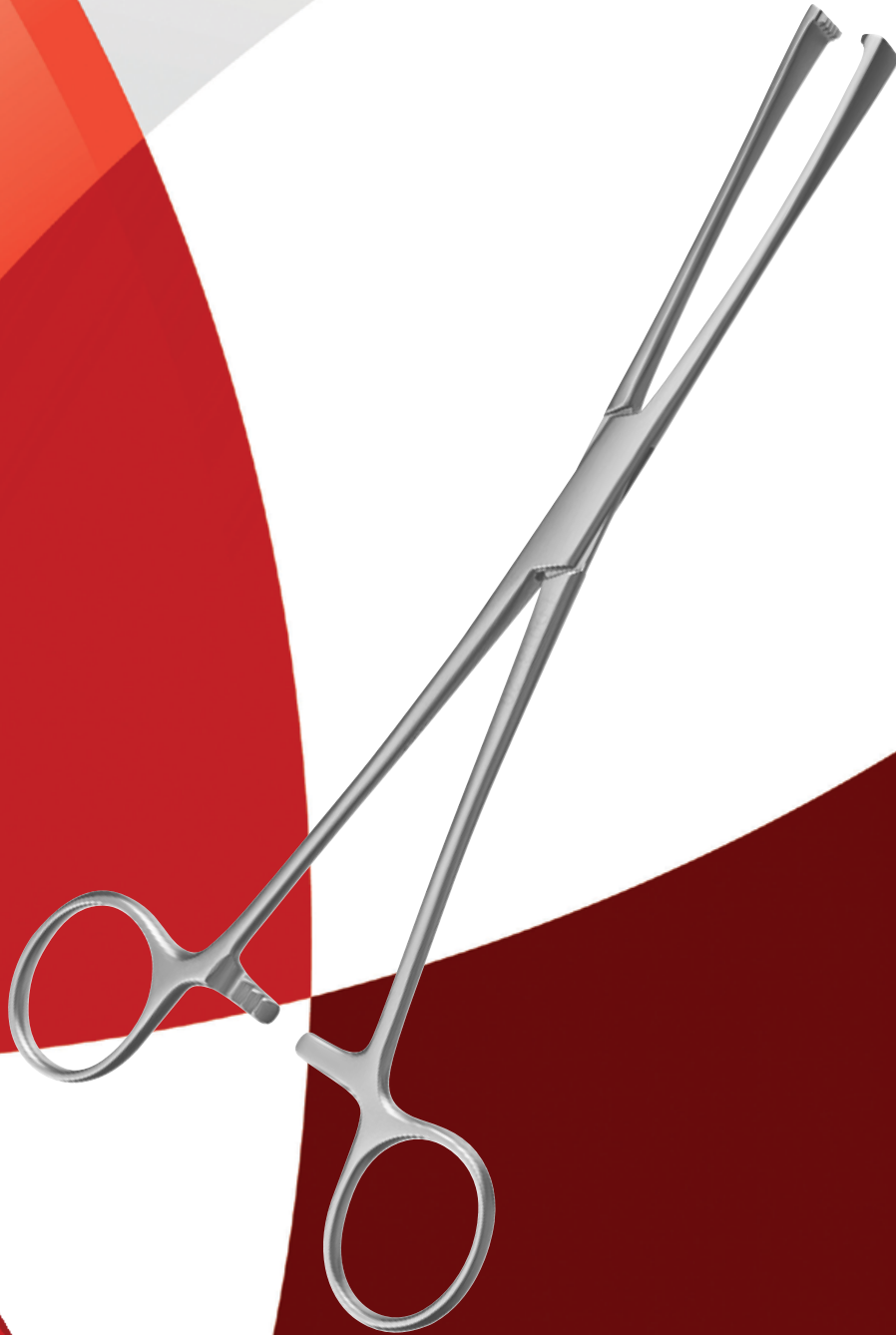

M.ASHRAF
INSTRUMENTS

Abdominale Chirurgie

Abdominal Surgery

Darm- und Gewebefasszangen	<i>Intestinal and Tissue Grasping Forceps</i>	AS 1 - 6
Darmklemmen	<i>Intestinal Clamps</i>	AS 7 - 13
Magenklemmen	<i>Stomach Clamps</i>	AS 14
Magen- und Darmquetschklemmen	<i>Intestinal and Pylorus Clamps</i>	AS 15
Magen- und Darm-Zwillingsklemmen	<i>Stomach and Intestinal Twin Clamps</i>	AS 16
Anastomosenklemmen	<i>Anastomosis Clamps</i>	AS 17
Rektum-Anastomosenklemmen	<i>Sigmoid Anastomosis Clamps</i>	AS 18 - 19
Rektum-Spekula	<i>Rectal Specula</i>	AS 20 - 21
Rektoskope	<i>Rectoscopes</i>	AS 22 - 23
Analspreizer	<i>Rectal Spreader</i>	AS 24
Rektum-Biopsiefasszange	<i>Rectal Biopsy Forceps</i>	AS 25
Hämorrhoidalzangen	<i>Haemorrhoidal Forceps</i>	AS 26 - 27
Hämorrhoidal-Ligatoren	<i>Haemorrhoidal Ligators</i>	AS 28 - 30
Gallenkanal-Klemmzangen	<i>Gall Duct Forceps</i>	AS 31 - 32
Gallenkanal Instrumente	<i>Gall Duct Instruments</i>	AS 33 - 34
Nierenklemmen	<i>Kidney Clamps</i>	AS 35
Nierensteinzangen	<i>Kidney Stone Forceps</i>	AS 36
Blasenwundspreizer	<i>Bladder Retractors</i>	AS 37 - 38
Urologie-Instrumente	<i>Urology Instruments</i>	AS 39 - 43

Darm- und Gewebefasszangen Intestinal and Tissue Grasping Forceps

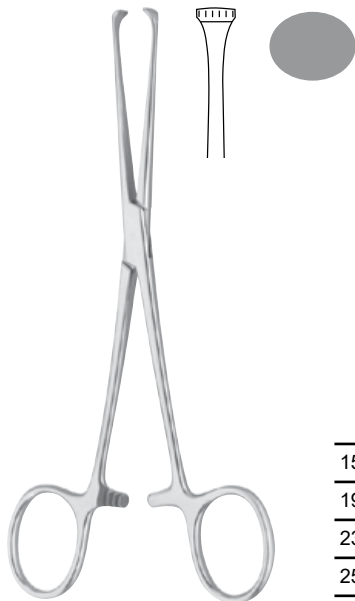

ALLIS

	4 : 5 Zähne 4 : 5 teeth	5 : 6 Zähne 5 : 6 teeth
15 cm – 6"	MA 6500-15	MA 6502-15
19 cm – 7½"	–	MA 6502-19
23 cm – 9"	–	MA 6502-23
25 cm – 10"	–	MA 6502-25



BABY-ALLIS

	4 : 5 Zähne 4 : 5 teeth
12 cm – 4¾"	MA 6504-12
14 cm – 5½"	MA 6504-14

Darm- und Gewebefasszangen Intestinal and Tissue Grasping Forceps



ALLIS-ATRAUMA

16 cm – 6¼"	MA 6505-16
20 cm – 8"	MA 6505-20
22 cm – 8¾"	MA 6505-22
25 cm – 10"	MA 6505-25
30 cm – 11¾"	MA 6505-30

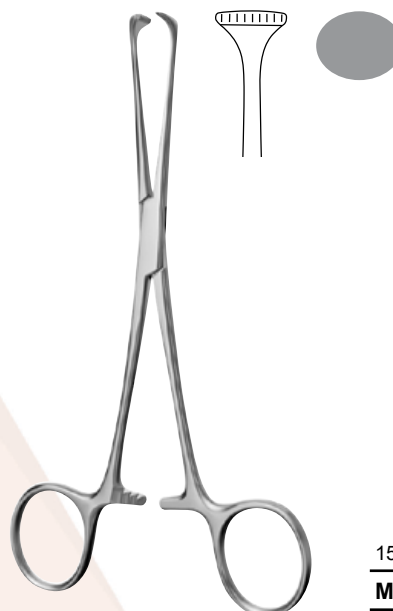

ALLIS-ADAIR

15 cm – 6"
MA 6506-15

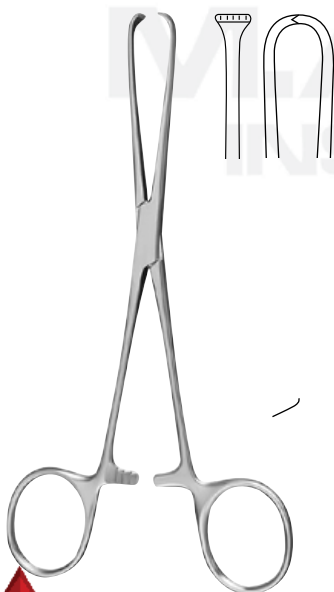

BOYS-ALLIS

15 cm – 6"
MA 6508-15

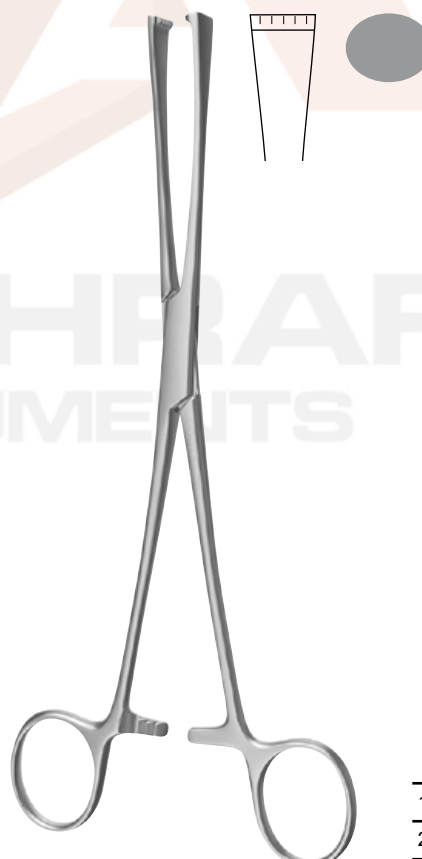

LOCKWOOD-ALLIS

	4 : 5 Zähne 4 : 5 teeth
16 cm – 6¼"	MA 6509-16
20 cm – 8"	MA 6509-20

Darm- und Gewebefasszangen Intestinal and Tissue Grasping Forceps

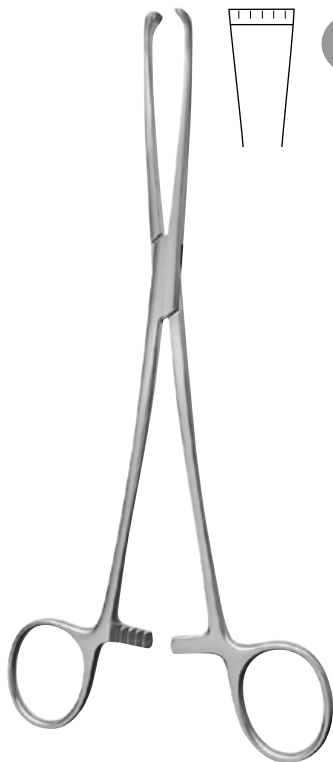

THOMS-ALLIS

6 : 7 Zähne
6 : 7 teeth

20 cm – 8"

MA 6510-20

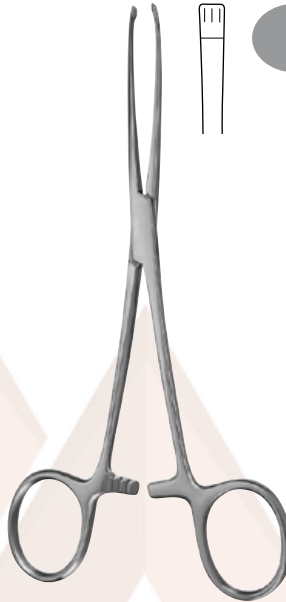

JUDD-ALLIS

3 : 4 Zähne
3 : 4 teeth

15 cm – 6"

MA 6512-15

19 cm – 7½"

MA 6512-19



LITTLEWOOD

2 : 3 Zähne
2 : 3 teeth

18,5 cm – 7¼"

MA 6513-18

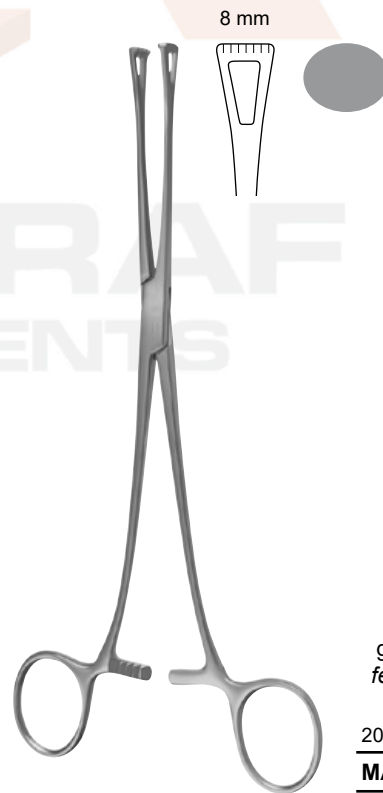

LOCKWOOD

gefenstert
fenestrated

20 cm – 8"

MA 6515-20

Darm- und Gewebefasszangen Intestinal and Tissue Grasping Forceps

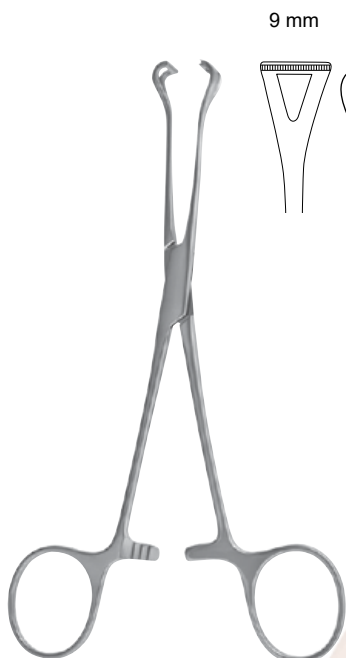

BABCOCK-ATRAUMA

16 cm – 6¼"	MA 6517-16
20 cm – 8"	MA 6517-20



DE BAKEY Zahnung
DE BAKEY Serration



BABCOCK

16 cm – 6¼"	MA 6518-16
18 cm – 7"	MA 6518-18
20 cm – 8"	MA 6518-20
24 cm – 9½"	MA 6518-24

Standardmodell
Standard pattern

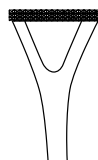

BABCOCK

	9 mm	12 mm
		
TC	16 cm – 6¼" MA 6519-16	20 cm – 8" MA 6519-20



M.ASHRAF
INSTRUMENTS

Darm- und Gewebefasszangen Intestinal and Tissue Grasping Forceps

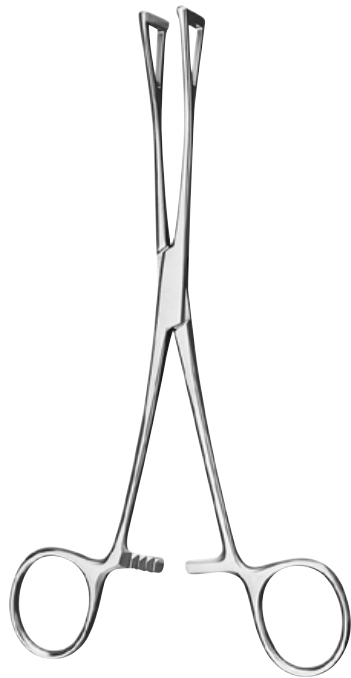

DUVAL

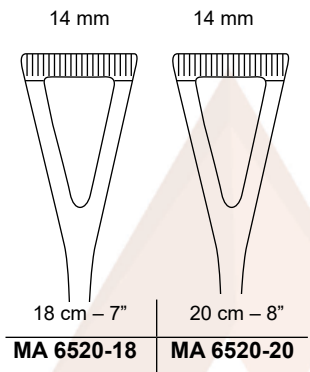

COLLIN

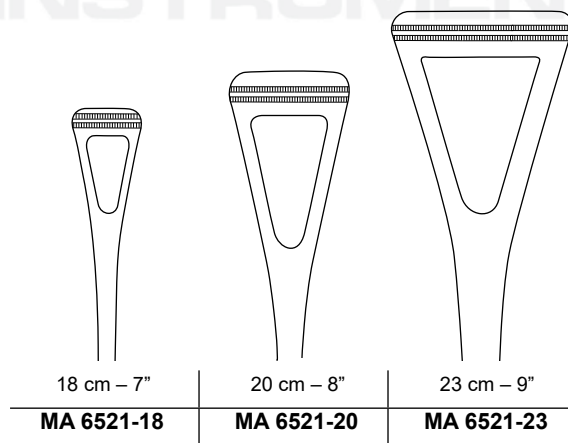

Darm- und Gewebefasszangen Intestinal and Tissue Grasping Forceps

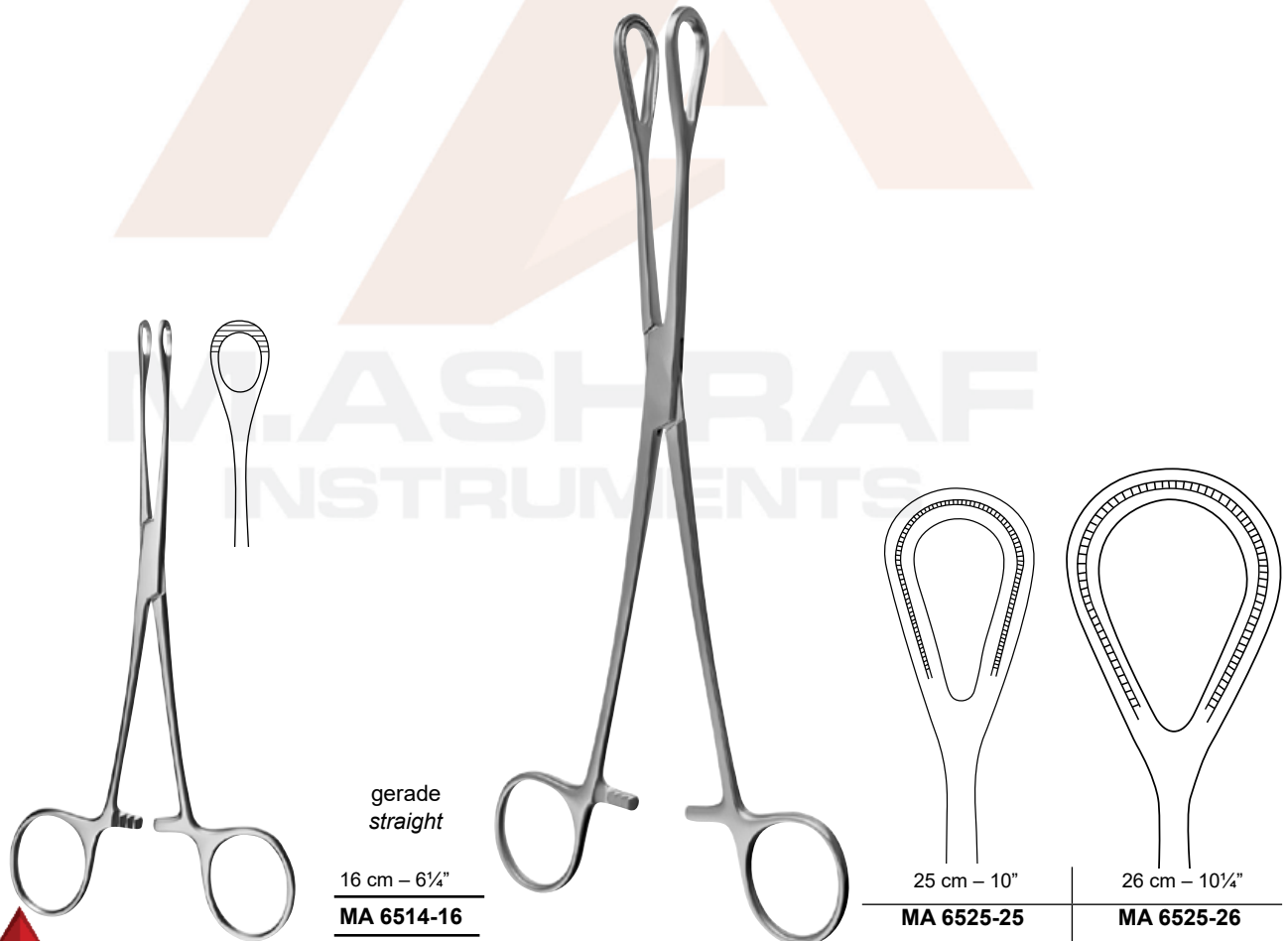
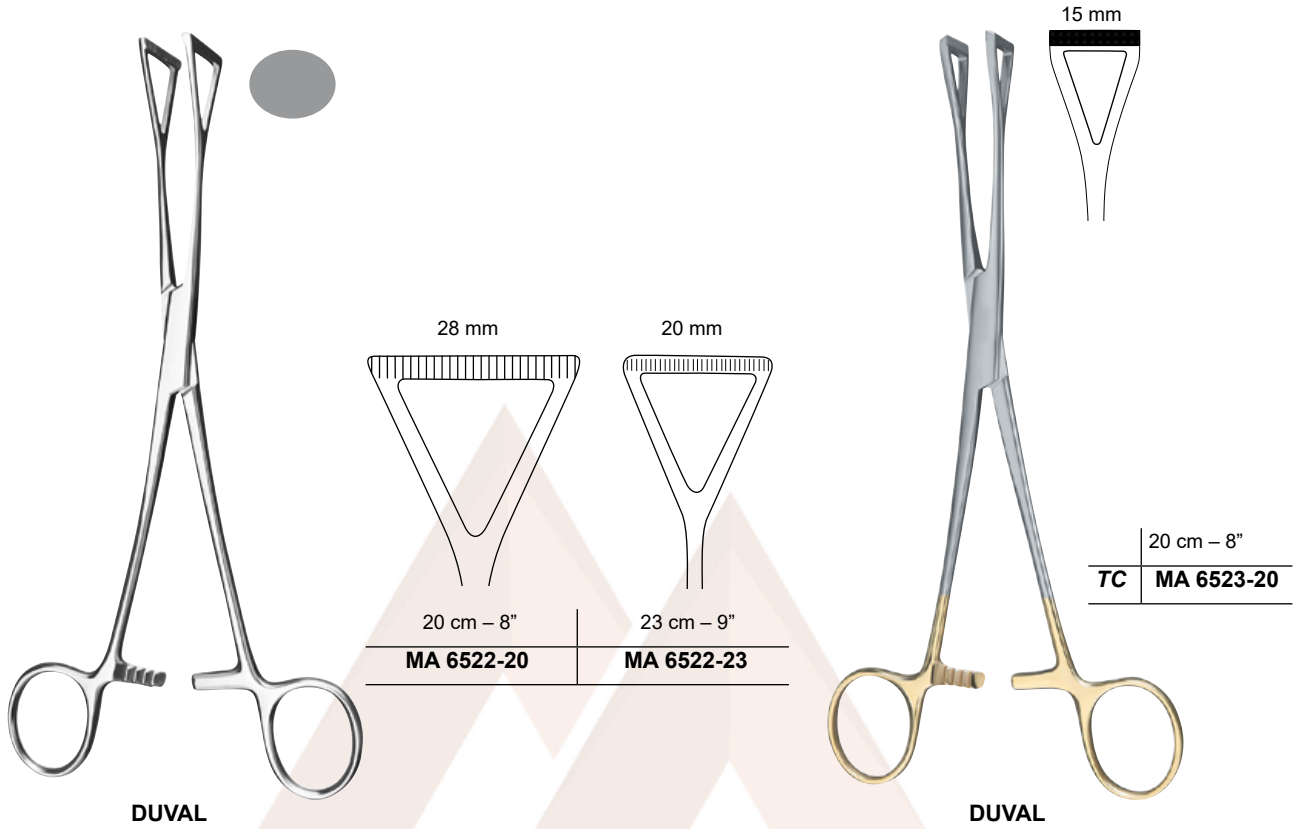



BABY-DOYEN

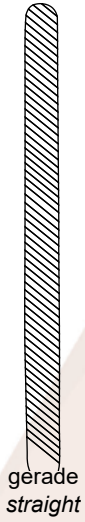

gerade
straight

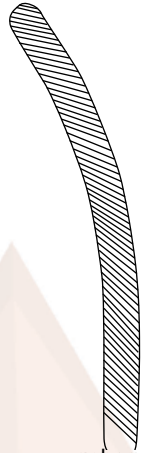

gebogen
curved

18 cm – 7"

MA 6530-18

MA 6531-18



DOYEN



gerade
straight



gebogen
curved

21 cm – 8¼"

MA 6530-21

MA 6531-21

23 cm – 9"

MA 6530-23

MA 6531-23

Darmklemmen Intestinal Clamps



DE BAKEY Zahnung
DE BAKEY Serration

gerade
straight

DOYEN-ATRAUMA



13 cm – 5"

MA 6534-13



16 cm – 6¼"

MA 6534-16



18 cm – 7"

MA 6534-18

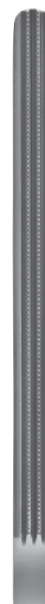

21 cm – 8¼"

MA 6534-21



23 cm – 9"

MA 6534-23



DE BAKEY Zahnung
DE BAKEY Serration

gebogen
curved

DOYEN-ATRAUMA



13 cm – 5"

MA 6535-13



16 cm – 6¼"

MA 6535-16



18 cm – 7"

MA 6535-18



21 cm – 8¼"

MA 6535-21



23 cm – 9"

MA 6535-23

Darmklemmen Intestinal Clamps



MAYO-ROBSON

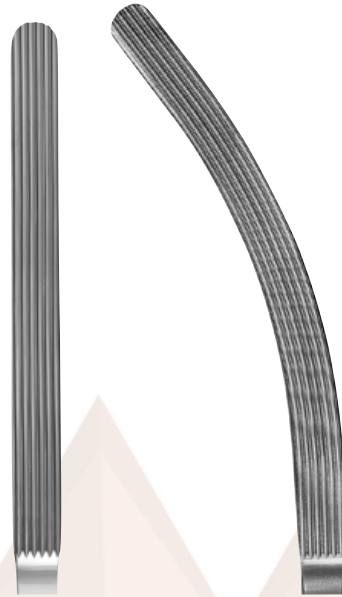

gerade
straight

gebogen
curved

21 cm – 8¼"

21 cm – 8¼"

MA 6540-21

MA 6541-21



gerade
straight

gebogen
curved

23 cm – 9"

23 cm – 9"

MA 6540-23

MA 6541-23

Darmklemmen Intestinal Clamps

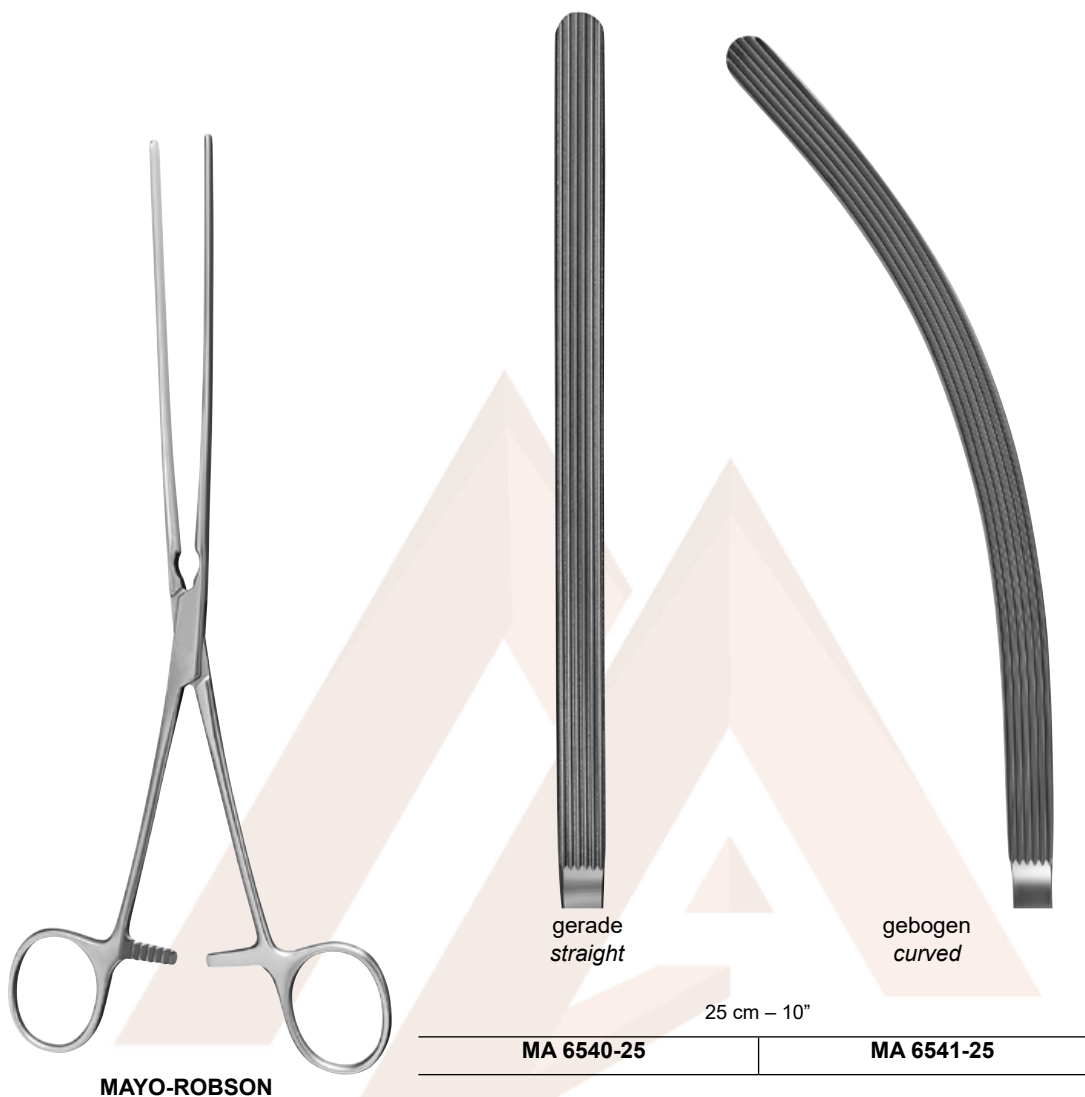

M.ASHRAF
INSTRUMENTS

Darmklemmen Intestinal Clamps



DE BAKEY Zahnung
DE BAKEY Serration

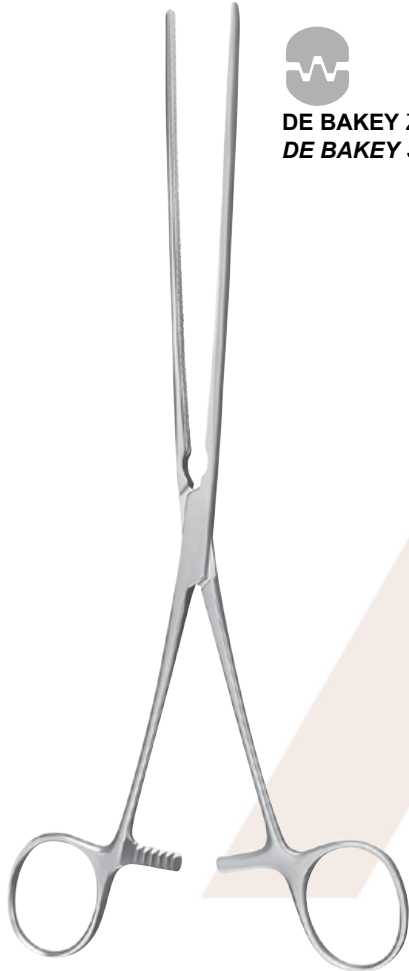

MAYO-ROBSON ATRAUMA



gerade
straight



gebogen
curved

25 cm – 10"

MA 6542-25

MA 6543-25

M.ASHRAF
INSTRUMENTS



BABY-KOCHER



gerade, sehr elastisch
straight, very elastic blades



gebogen, sehr elastisch
curved, very elastic blades

13 cm – 5"

MA 6550-13

MA 6551-13

Darmklemmen Intestinal Clamps

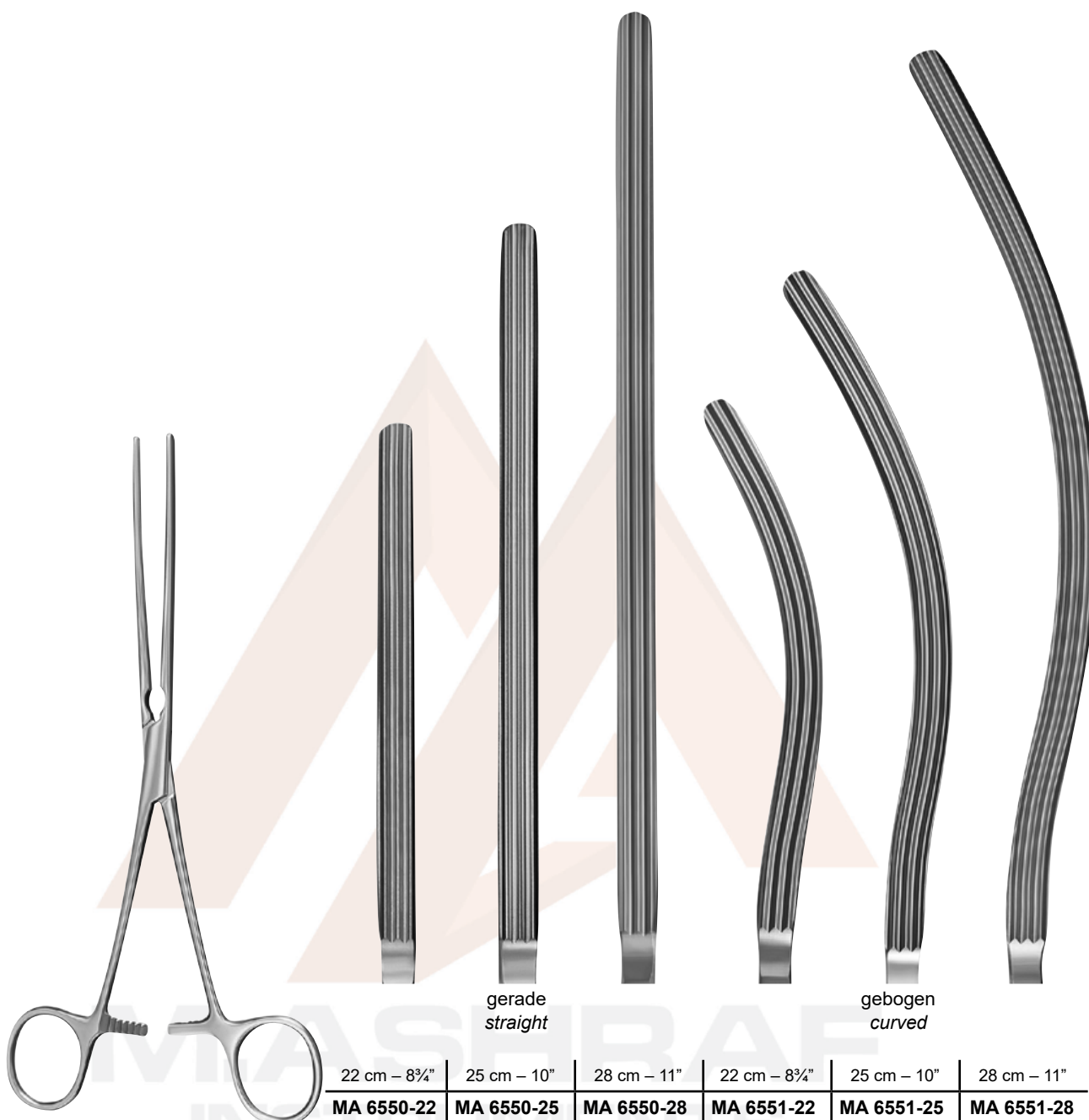

KOCHER

Darmklemmen Intestinal Clamps



DE BAKEY Zahnung
DE BAKEY Serration



KOCHER-ATRAUMA



gerade
straight

gebogen
curved

22 cm – 8¾"	25 cm – 10"	28 cm – 11"	22 cm – 8¾"	25 cm – 10"	28 cm – 11"
MA 6552-22	MA 6552-25	MA 6552-28	MA 6553-22	MA 6553-25	MA 6553-28

M.ASHRAF
INSTRUMENTS

Magenklemmen Stomach Clamps

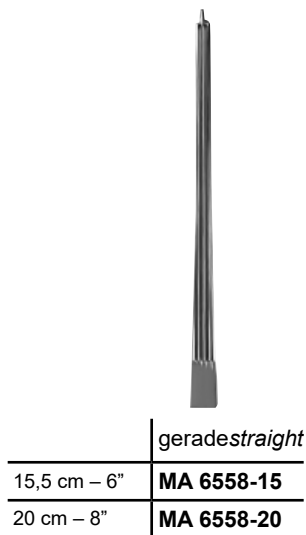
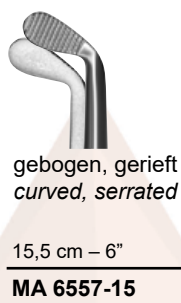
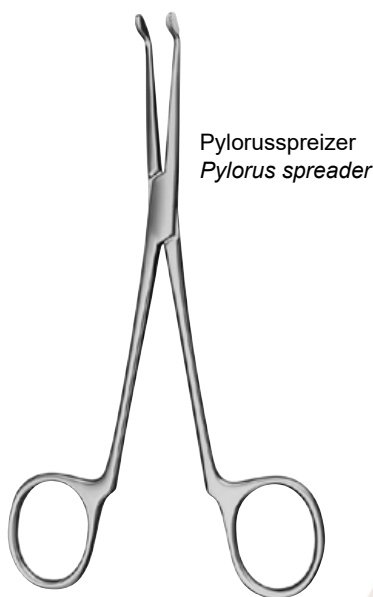

M.ASHRAF
INSTRUMENTS

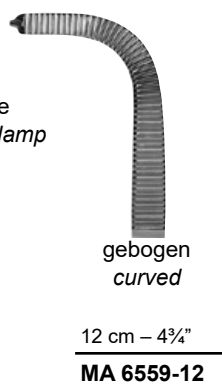
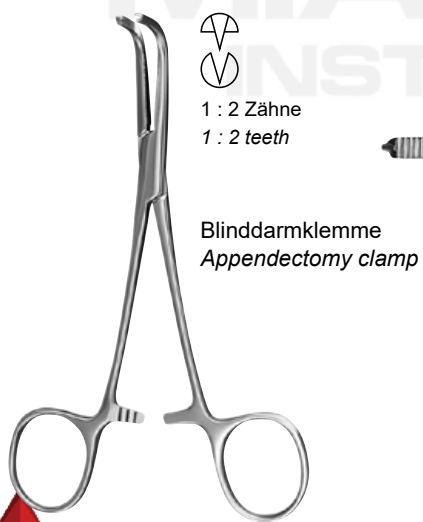

Magen- und Darmquetschklemmen Intestinal and Pylorus Clamps



PAYR

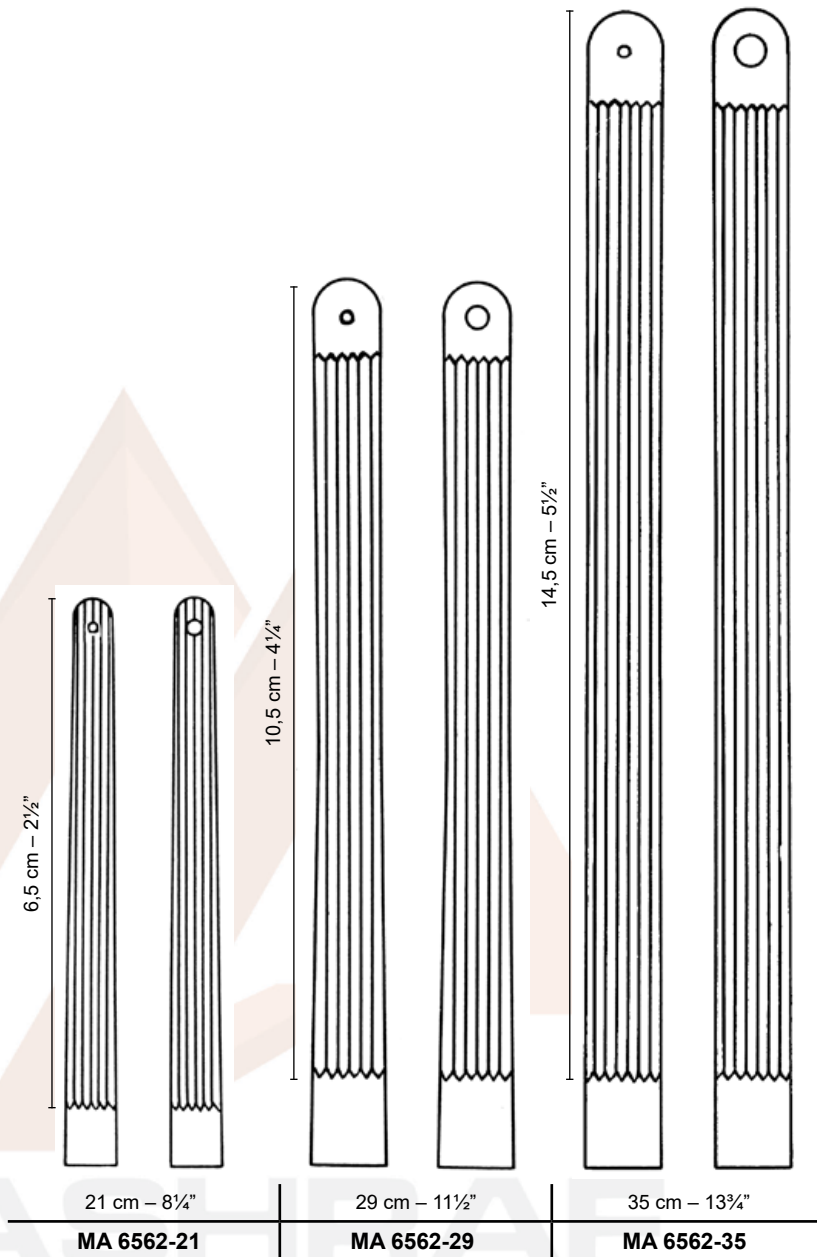

M.ASHRAF
INSTRUMENTS

Magen- und Darm-Zwillingsklemmen Stomach and Intestinal Twin Clamps

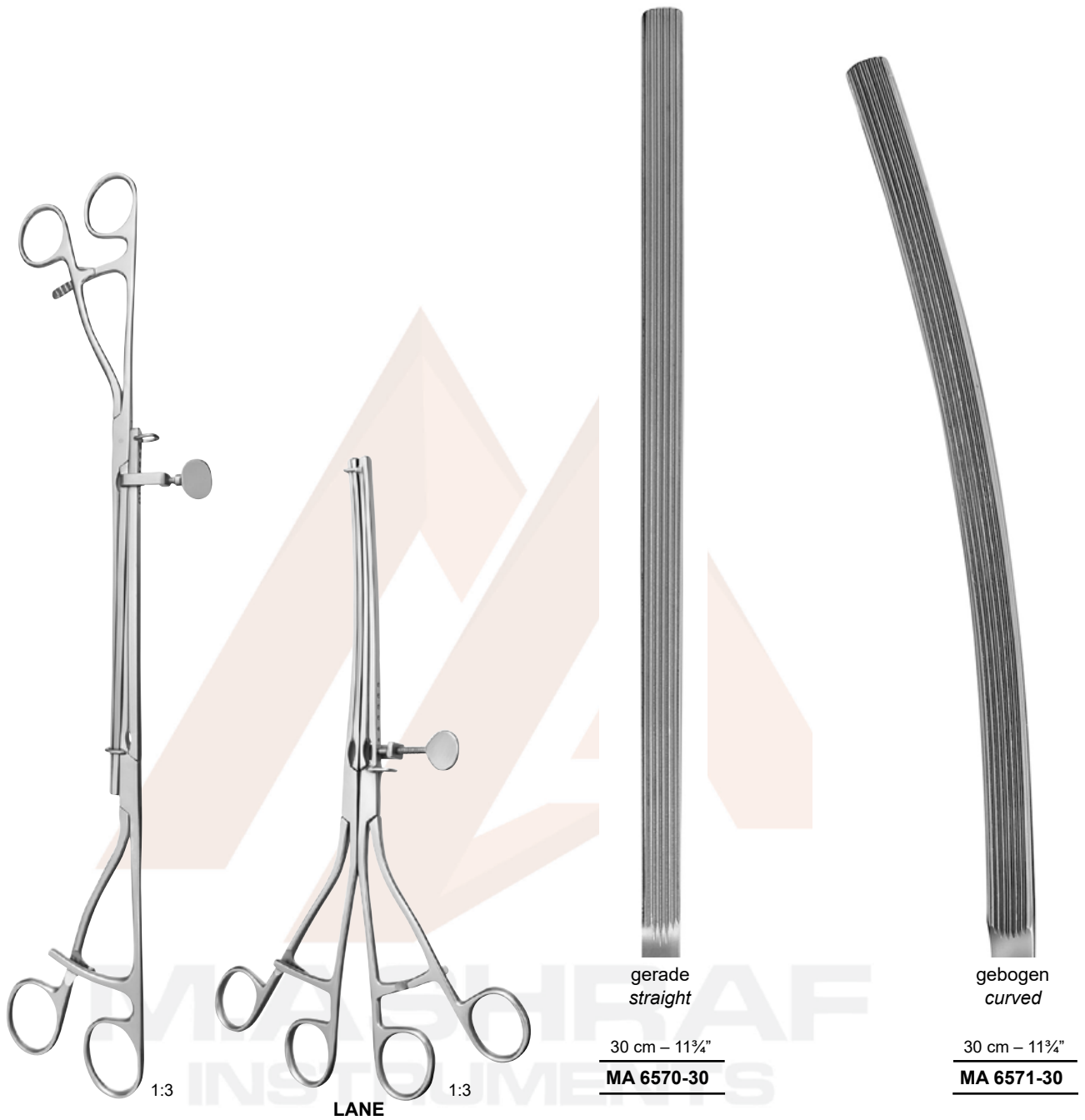

Anastomosenklemmen Anastomosis Clamps



Schließzange
Closing forceps

26 cm – 10¼"
MA 6580-00

DE MARTEL-WOLFSON

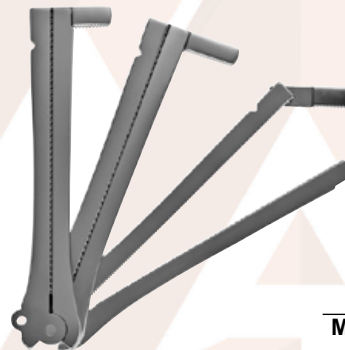

DE MARTEL-WOLFSON

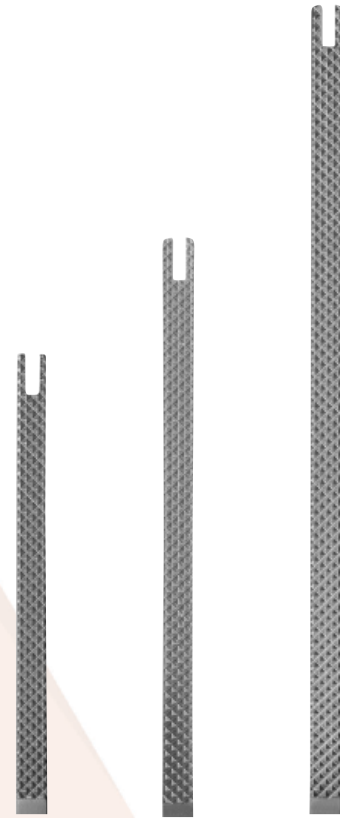

Satz von 3 Klemmen
Set of 3 clamps

5 cm – 2"	7 cm – 2¾"	10 cm – 4"
MA 6580-05	MA 6580-07	MA 6580-10



Klemmenhalter
für MA 6580-05, -07, -10
Clamp holder
for MA 6580-05, -07, -10



8,5 cm – 3¼"	MA 6580-20
23 cm – 9"	MA 6580-23

DE MARTEL-WOLFSON

MASHRAF
INSTRUMENTS

Rektum-Anastomosenklemmen Sigmoid Anastomosis Clamps



RESANO

1:3

30 cm – 11¾"

MA 6544-30



LLOYD-DAVIS

1:3

31,5 cm – 12½"

MA 6545-31



HAYES

1:3



DE BAKEY Zahnung
DE BAKEY Serration



26 cm – 10¼"

MA 6546-26



DE BAKEY Zahnung
DE BAKEY Serration



28 cm – 11"

MA 6546-28

Rektum-Anastomosenklemmen Sigmoid Anastomosis Clamps



DE BAKEY Zahnung
DE BAKEY Serration

FEHLAND

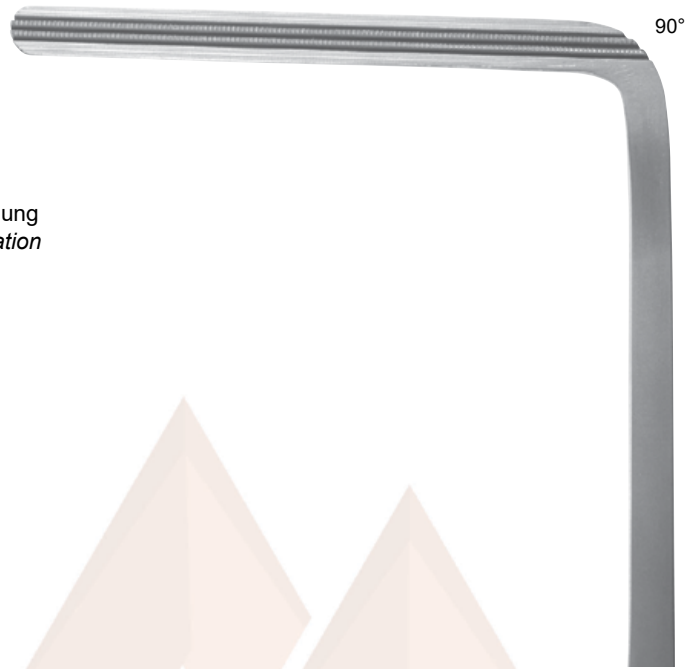

24 cm – 9½"

MA 6547-24



BRUNNER



24 cm – 9½"

MA 6548-24

MA 6549-24

DE BAKEY Zahnung
DE BAKEY Serration

M.ASHRAF
INSTRUMENTS



Rektum-Spekula Rectal Specula

Blattlänge
Length of blade

106 x 23 mm



22 cm – 8³/₄"

MA 6590-22

CZERNY

Blattlänge
Length of blade

80 x 25 mm



20,5 cm – 8"

MA 6591-20

PRATT

Blattlänge
Length of blade

89 x 17 mm



SIMS

15 cm – 6"

MA 6592-15



fenestriert
fenestrated

15 cm – 6"

MA 6593-15

Rektum-Spekula Rectal Specula



SIMS

Gesamtlänge Total length	Blattlänge Length of blade	
22 cm – 8¾"	80 x 20 mm	MA 6595-08
	125 x 20 mm	MA 6595-12



MATHIEU

Blattlänge
Length of blade
90 x 15 mm

19,5 cm – 7¾"
MA 6596-19



BARR

Blattlänge
Length of blade
70 x 22 mm

17 cm – 6¾"
MA 6597-17

Rektoskope
Rectoscopes

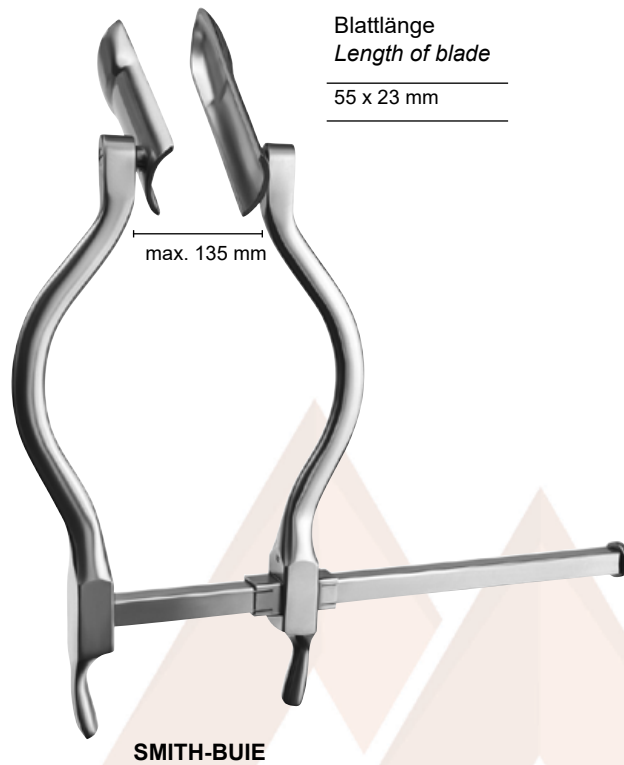

Blattlänge
Length of blade
55 x 23 mm

max. 135 mm

Analspreizer
Anal retractor

15 cm – 6"

MA 6598-15

SMITH-BUIE

M.ASHRAF
INSTRUMENTS

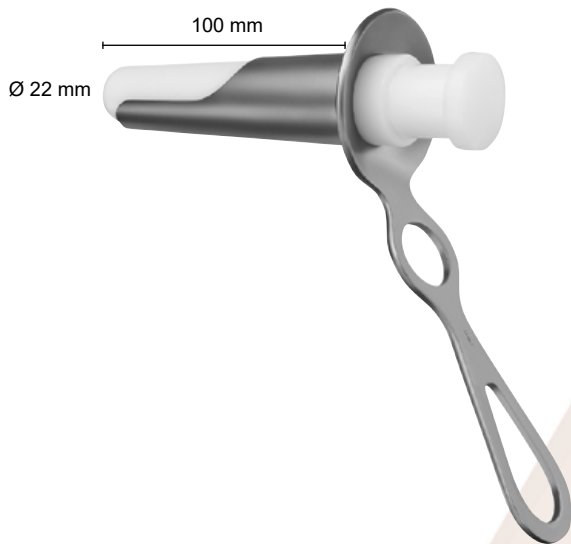

Anoskop
Anoscope

13,5 cm – 5¼"

MA 6604-00

IVES-FANSLER

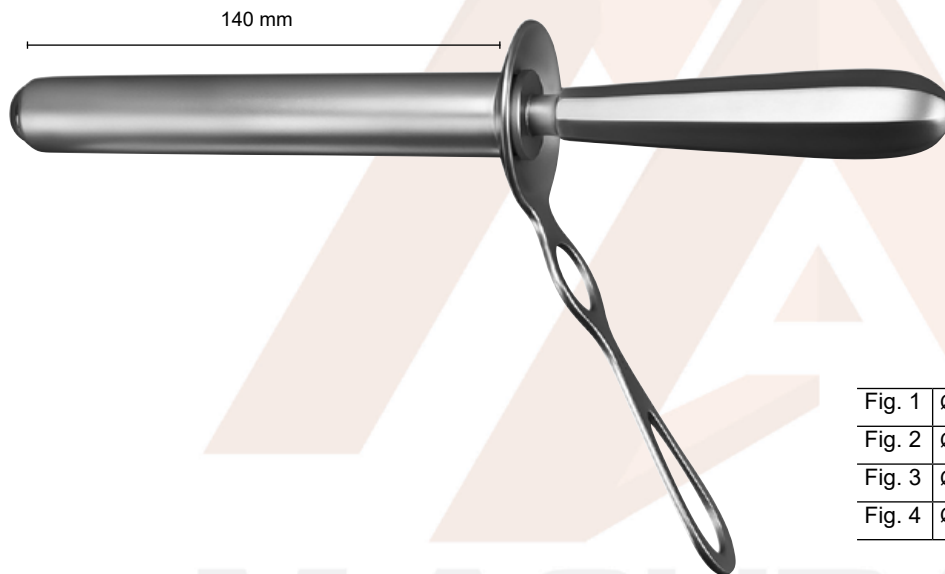

Proktoskope
Proctoscopes

Fig. 1	Ø 22 mm x 50 mm	MA 6605-01
Fig. 2	Ø 22 mm x 100 mm	MA 6605-02
Fig. 3	Ø 22 mm x 140 mm	MA 6605-03
Fig. 4	Ø 22 mm x 200 mm	MA 6605-04

KELLY



Sphinkteroskope
Sphincteroscopes

16 cm – 6¼"

Fig. 1	Ø 21 mm x 50 mm	MA 6606-01
Fig. 2	Ø 25 mm x 50 mm	MA 6606-02

KELLY

Analspreizer Rectal Spreader

Maßangaben für Mittelblätter
und Blätter

1. Zahl = Länge
2. Zahl = Breite

*Dimensions for central blades
and blades*

1st number = length

2nd number = width

Mittelblatt

Beispiel: 95 x 22 mm

Central blade

Example: 95 x 22 mm

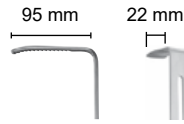

Blätter

Beispiel: 60 x 25 mm

Blades

Example: 60 x 25 mm

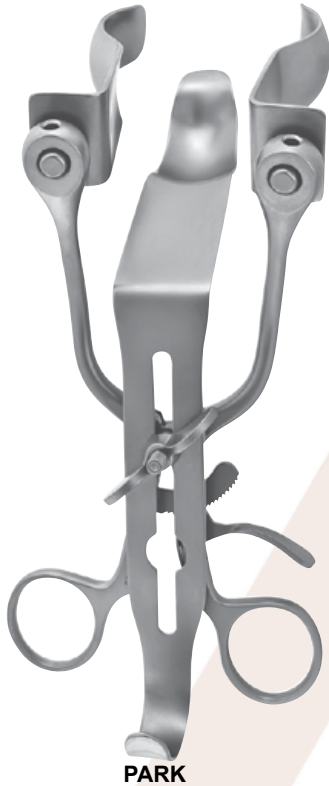
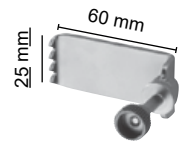

Sperrer allein <i>Retractor only</i>	MA 6608-01
---	-------------------

Satz komplett, bestehend aus: <i>Set complete, consisting of:</i>	MA 6608-00
--	-------------------

Sperrer allein, 14,5 cm – 5 $\frac{3}{4}$ " (MA 6608-01)
Retractor only, 14,5 cm – 5 $\frac{3}{4}$ " (MA 6608-01)

1 Mittelblatt 95 x 22 mm (MA 6608-20)

1 Central blade 95 x 22 mm (MA 6608-20)

1 Paar Blätter seitlich, 70 x 20 mm (MA 6608-27)

1 pair of blades lateral, 70 x 20 mm (6608-27)

1 Paar Blätter seitlich, 90 x 20 mm (MA 6608-29)

1 pair of blades lateral, 90 x 20 mm (6608-29)

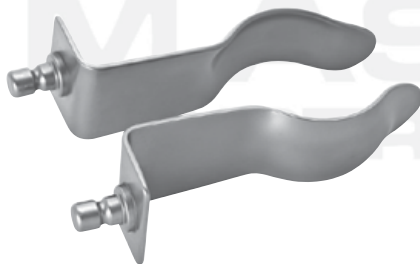

Rektum-Biopsiefasszangen Rectal Biopsy Forceps

Schaftlänge
Shaft length

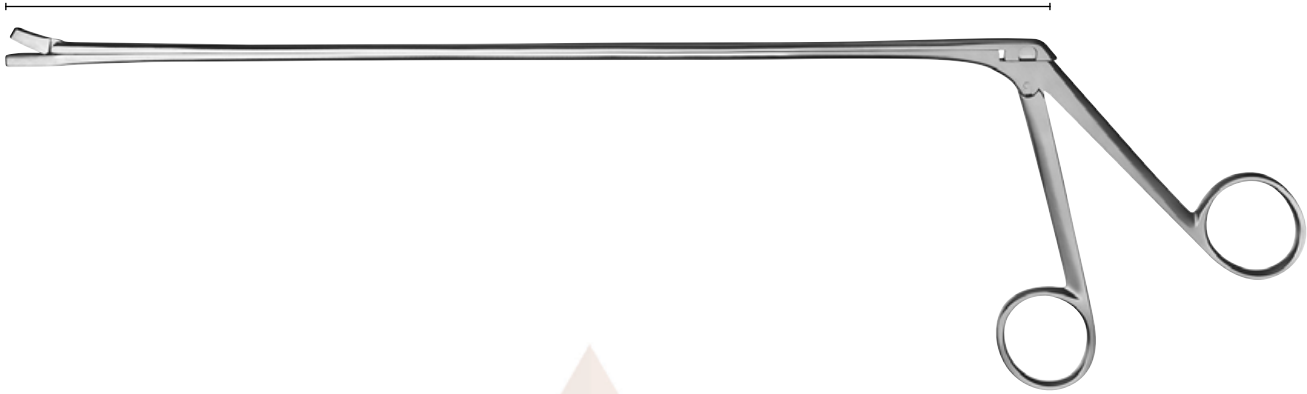

YEOMAN

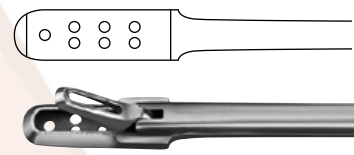
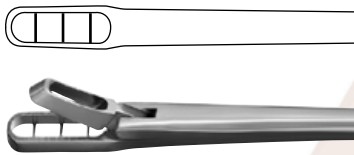

	Bissbreite Bite width	Schaftlänge Shaft length	Fig. 1
	3 mm	28 cm – 11"	MA 6610-28
		35 cm – 13¾"	MA 6610-35
		42 cm – 16½"	MA 6610-42

	Bissbreite Bite width	Schaftlänge Shaft length	Fig. 2
	4 mm	28 cm – 11"	MA 6611-28
		35 cm – 13¾"	MA 6611-35
		42 cm – 16½"	MA 6611-42

M.ASHRAF
INSTRUMENTS

Hämorrhoidalzangen Haemorrhoidal Forceps



PRATT



15 cm – 6"

MA 3150-15



FERGUSSON



gerade
straight

16 cm – 6¼"

MA 3390-16



gebogen
curved

MA 3391-16



HEYWOOD-SMITH



gerade
straight

21 cm – 8¼"

MA 6616-20



HEYWOOD-SMITH



gerade
straight

21 cm – 8¼"

MA 6617-21

Hämorrhoidalzangen Haemorrhoidal Forceps



MC GIVNEY

19 cm – 7½"

MA 6622-19

M.ASHRAF
INSTRUMENTS

Hämorrhoidal-Ligatoren Haemorrhoidal Ligators



Hämorrhoidal-Ligator komplett, bestehend aus:
Haemorrhoidal ligator complete, consisting of:

MA 6620-00

- 1 Hämorrhoidal-Ligator (MA 6620-01)
- 1 *Haemorrhoidal ligator* (MA 6620-01)
- 1 Ladekonus Ø 10 mm (MA 6620-10)
- 1 *Charging cone* Ø 10 mm (MA 6620-10)
- 1 Saugkopf 11 mm x Ø 10 mm (MA 6620-11)
- 1 *Aspiration tip* 11 mm x Ø 10 mm (MA 6620-11)
- 1 Saugkopf 16 mm x Ø 10 mm (MA 6620-16)
- 1 *Aspiration tip* 16 mm x Ø 10 mm (MA 6620-16)
- 1 Ligatur-Gummiringe (100 Stück) (MA 6620-51)
- 1 *Ligature rubber rings* (100 pieces) (MA 6620-51)



Ø 10 mm

Ladekonus
Charging cone

MA 6620-10

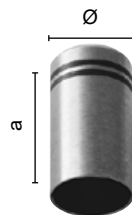

a	Ø	Saugkopf <i>Aspiration tip</i>
11 mm	10 mm	MA 6620-11
16 mm	10 mm	MA 6620-16



Ligatur-Gummiringe, **latexfrei**,
Verpackungseinheit 100 Stück

Ligature rubber rings, latex free,
packing unit 100 pieces

MA 6620-51

Hämorrhoidal-Ligatoren Haemorrhoidal Ligators

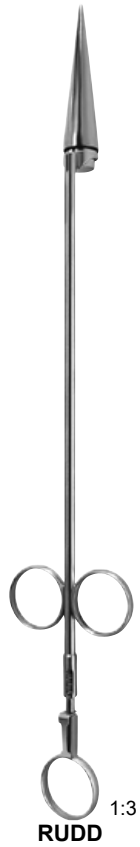

Ladekonus
Charging cone

MA 6621-12



Ligatur-Gummiringe, **latexfrei**,
Verpackungseinheit 100 Stück

Ligature rubber rings, **latex free**,
packing unit 100 pieces

MA 6620-51

Hämorrhoidal-Ligator komplett, bestehend aus:
Haemorrhoidal ligator complete, consisting of:

MA 6621-00

1 Hämorrhoidal-Ligator, 31,5 cm – 12½" (MA 6621-01)
1 Haemorrhoidal ligator, 31,5 cm – 12½" (MA 6621-01)

1 x Ladekonus Ø 12 mm (MA 6621-12)
1 x Charging cone Ø 12 mm (MA 6621-12)

1 x Ligatur-Gummiringe (100 Stück) (MA 6620-51)
1 x Ligature rubber rings (100 pieces) (MA 6620-51)

Hämorrhoidal-Ligator komplett, bestehend aus:
Haemorrhoidal ligator complete, consisting of:

MA 6622-00

1 x Hämorrhoidal-Ligator
1 x Haemorrhoidal ligator

1 x Ladekonus Ø 13 mm (MA 6622-21)
1 x Charging cone Ø 13 mm (MA 6622-21)

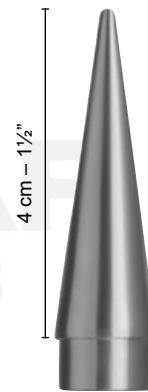

Ladekonus, Ø 13 mm
Charging cone, Ø 13 mm

MA 6622-21

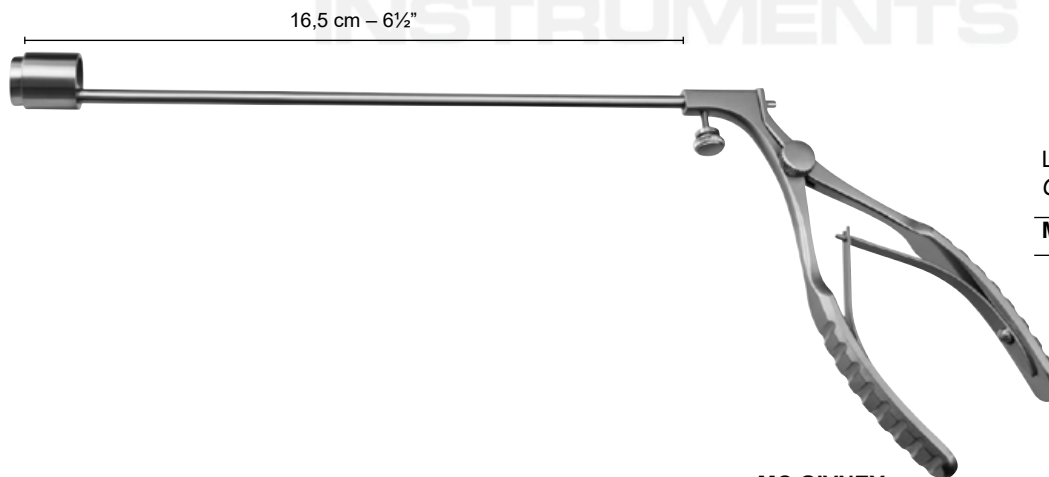

Hämorrhoidal-Ligatoren Haemorrhoidal Ligators

Hämorrhoidal-Ligatur komplett, bestehend aus: <i>Haemorrhoidal ligator complete, consisting of:</i>	MA 6622-05
1 x Hämorrhoidal-Ligatur <i>1 x Haemorrhoidal ligator</i>	
1 x Ladekegel Ø 13 mm (MA 6622-21) <i>1 x Charging cone Ø 13 mm (MA 6622-21)</i>	

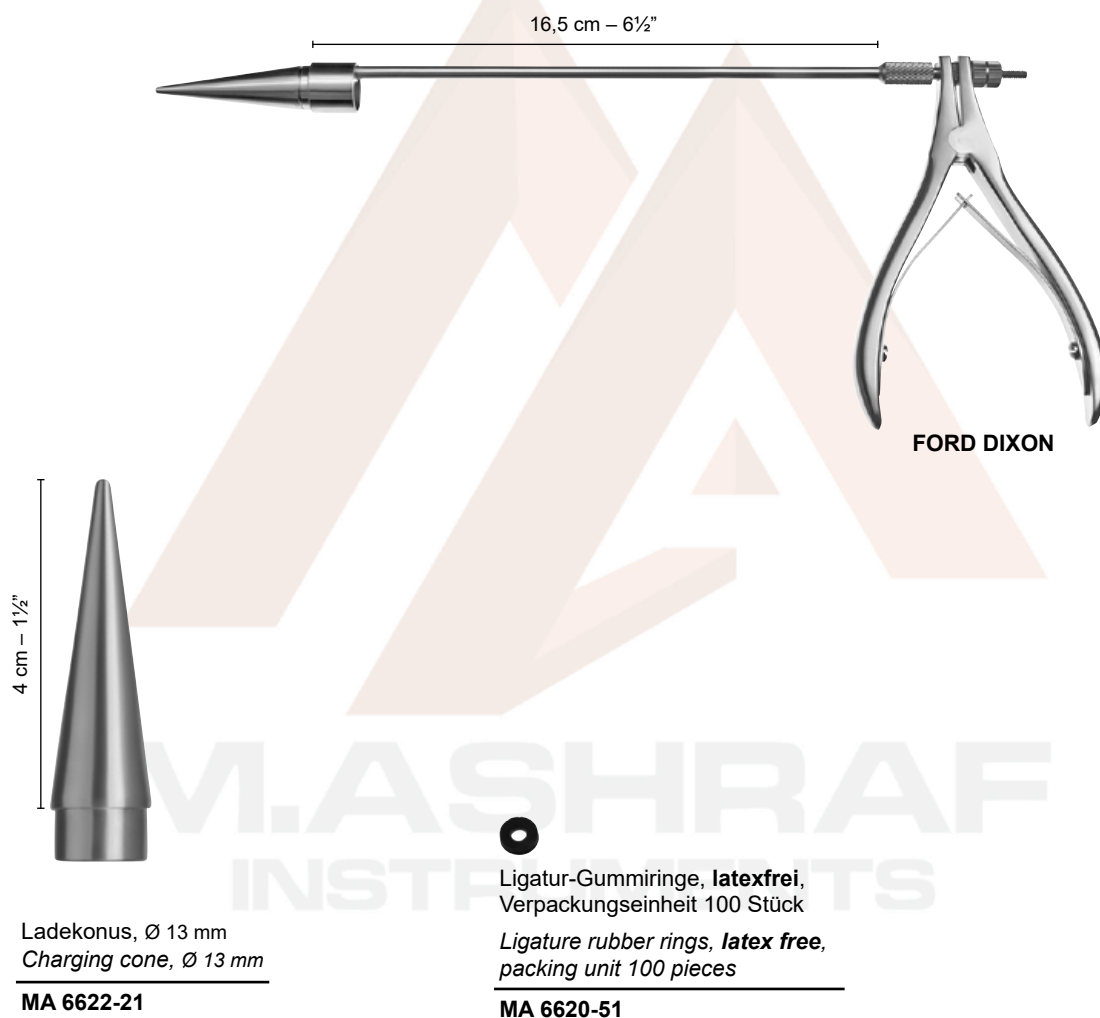

Gallenkanal-Klemmzangen
Gall Duct Forceps

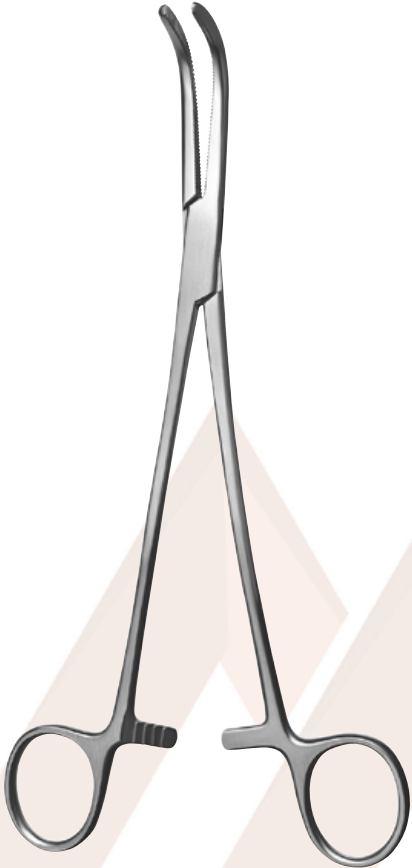

GRAY

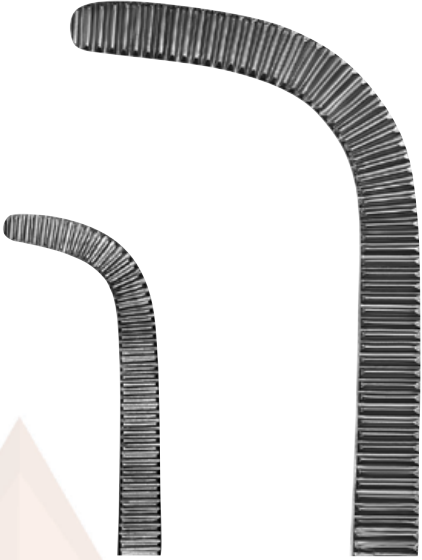
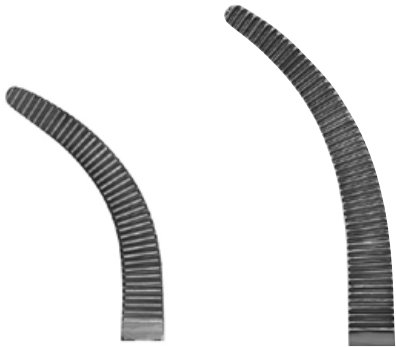

Fig. 1	Fig. 2
22 cm – 8¾"	23 cm – 9"
MA 6642-01	MA 6642-02
Satz à Fig. 1 und Fig. 2 Set of fig. 1 and fig. 2	
MA 6642-00	



23 cm – 9"	24 cm – 9½"
MA 3401-23	MA 3401-24

M.ASHRAF
INSTRUMENTS



Gallenkanal-Klemmzangen Gall Duct Forceps

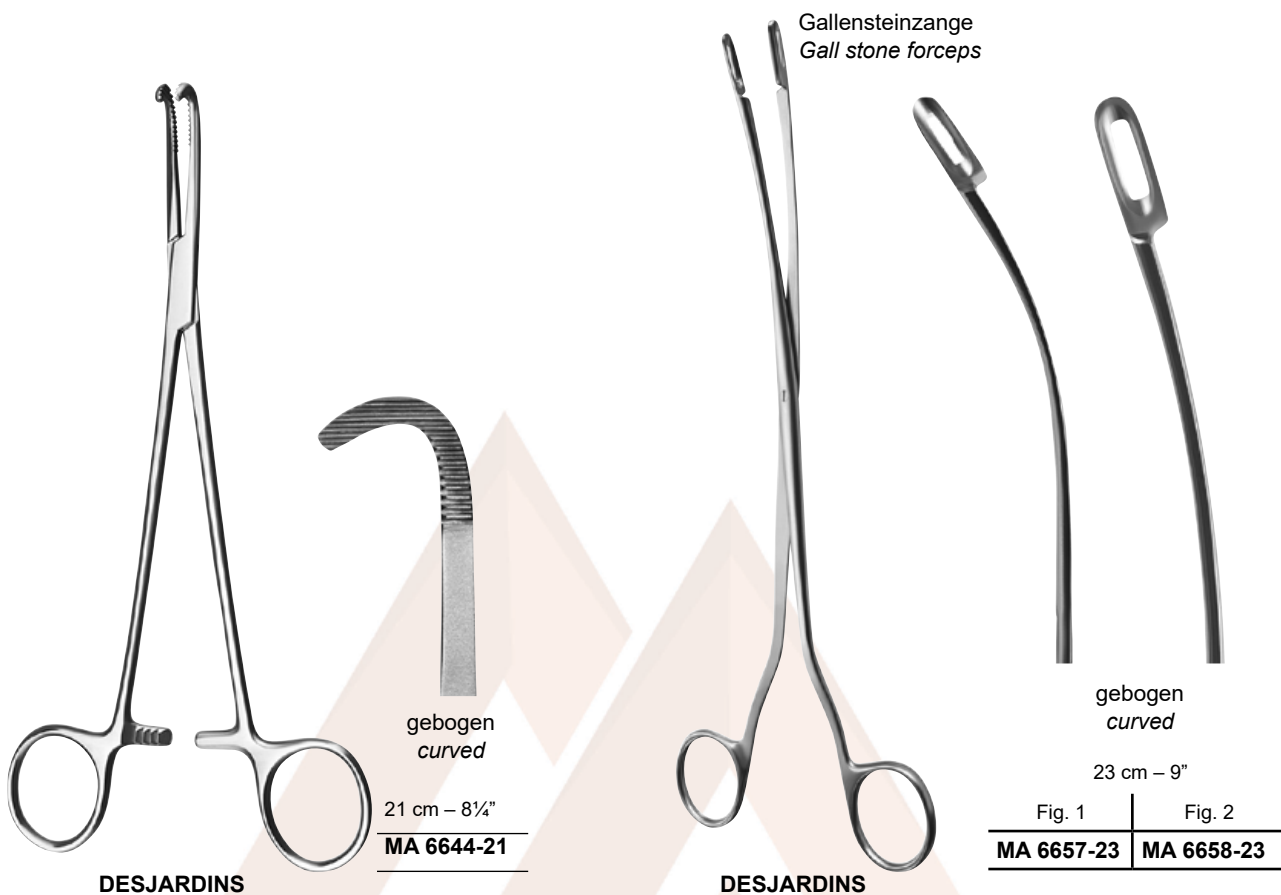

M.ASHRAF
INSTRUMENTS



Gallengangdilatoren,
biegsam

*Gall duct dilators,
malleable*

mm	30 cm – 11¾"
1	MA 6665-01
2	MA 6665-02
3	MA 6665-03
4	MA 6665-04
5	MA 6665-05
6	MA 6665-06
7	MA 6665-07
8	MA 6665-08
9	MA 6665-09
10	MA 6665-10
11	MA 6665-11
12	MA 6665-12
13	MA 6665-13

Satz à 9 Stück
MA 6665-03 – MA 6665-11

*Set of 9 pieces
MA 6665-03 – MA 6665-11*

MA 6665-00

Satz à 9 Stück
MA 6665-03 – MA 6665-11
in Leinentuchtasche

*Set of 9 pieces
MA 6665-03 – MA 6665-11
in canvas pocket*

MA 6665-50

Leinentuchtasche, allein
Canvas pocket, only

MA 6665-71



*federnd
elastic*

DESJARDINS

30 cm – 12"



Fig. 1

MA 6670-01



Fig. 2

MA 6670-02



Fig. 3

MA 6670-03



Fig. 4

MA 6670-04

Gallenkanal Instrumente Gall Duct Instruments

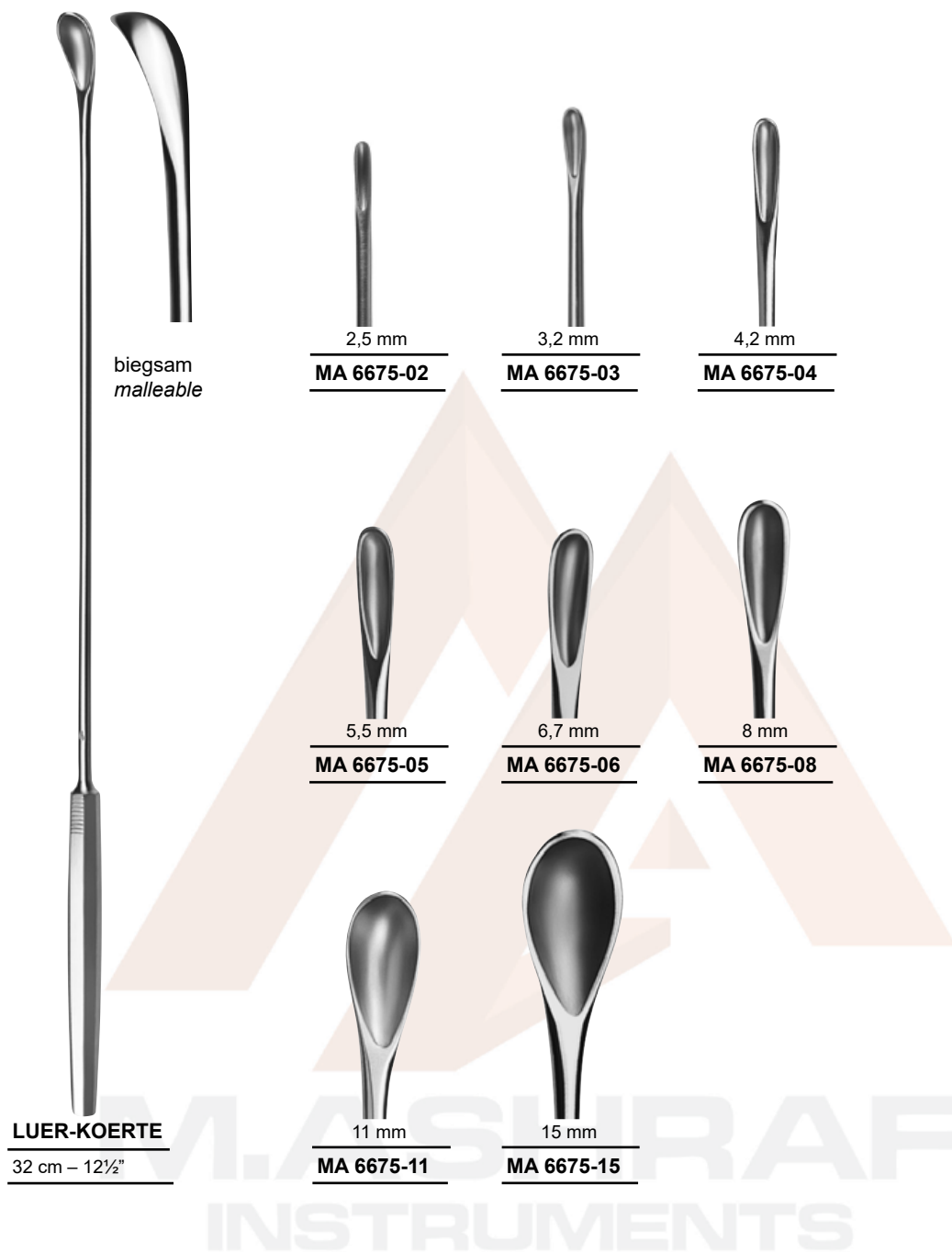

Nierenklemmen Kidney Clamps

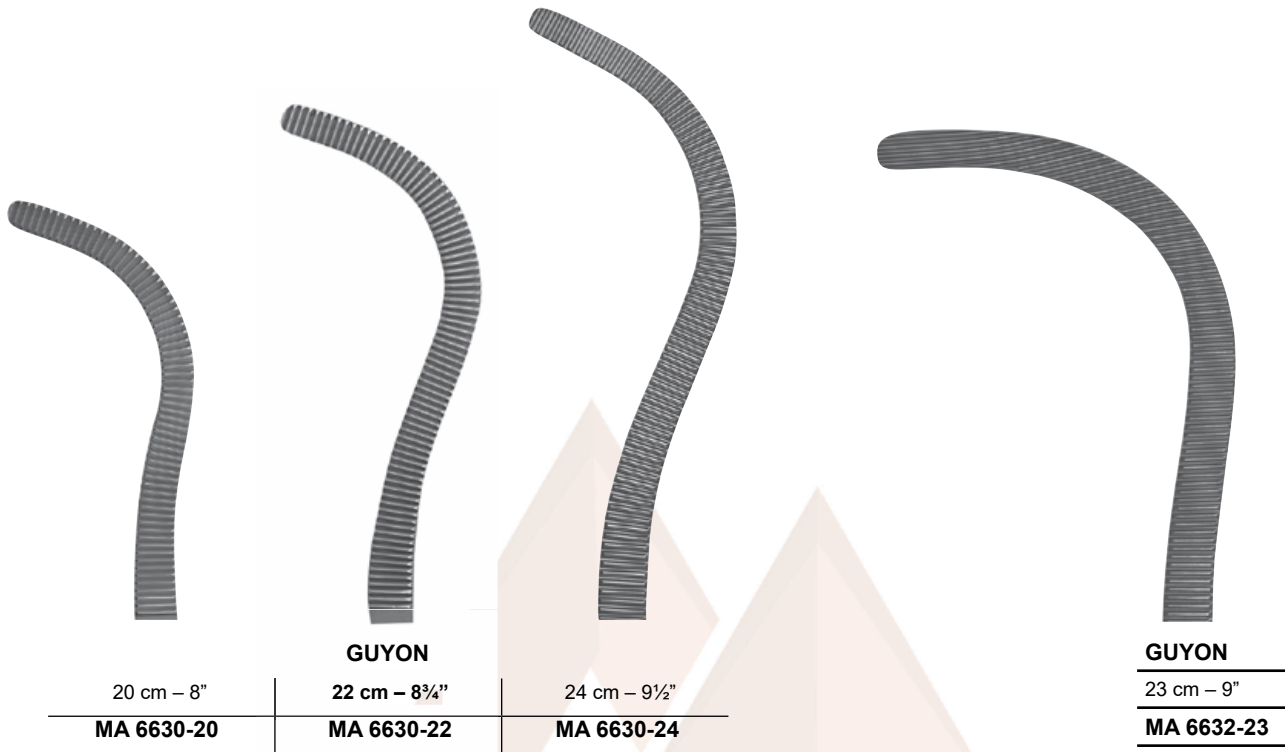

DE BAKEY Zahnung
DE BAKEY Serration

GUYON / GUYON-ATRAUMA

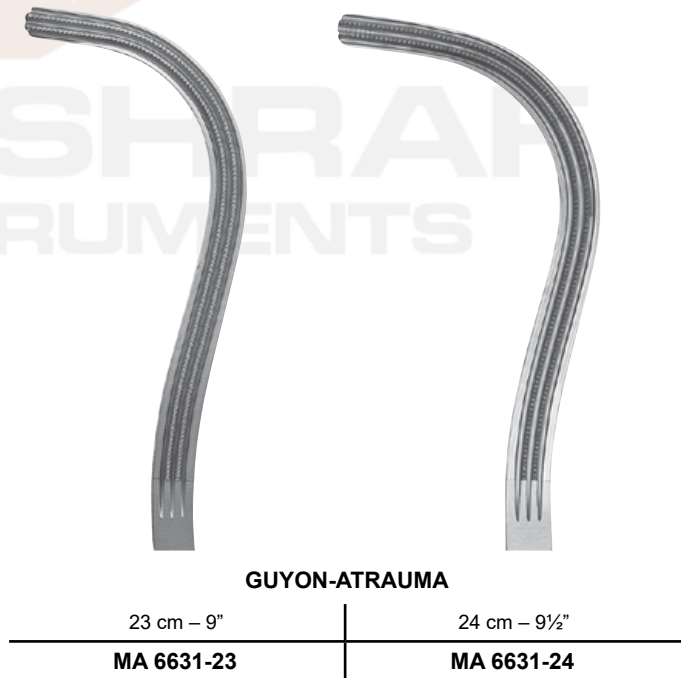

Nierensteinzangen Kidney Stone Forceps

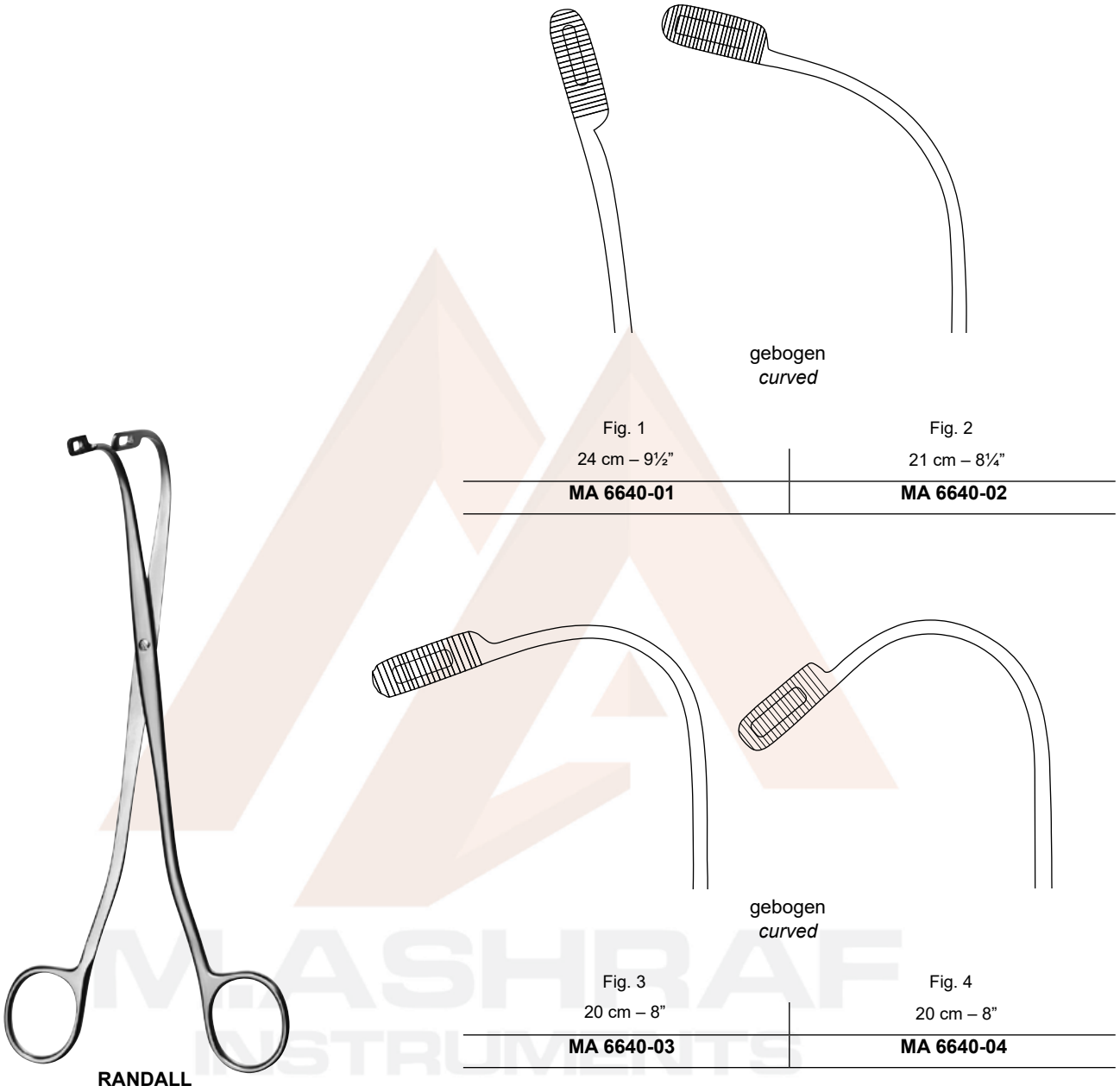

Blasenwundspreizer Bladder Retractors

Maßangaben für Mittelblätter
und Blätter

1. Zahl = Länge
2. Zahl = Breite

*Dimensions for central blades
and blades*

1st number = length

2nd number = width

Mittelblatt

Beispiel: 95 x 22 mm

Central blade

Example: 95 x 22 mm

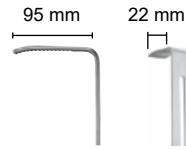

Blätter

Beispiel: 60 x 25 mm

Blades

Example: 60 x 25 mm

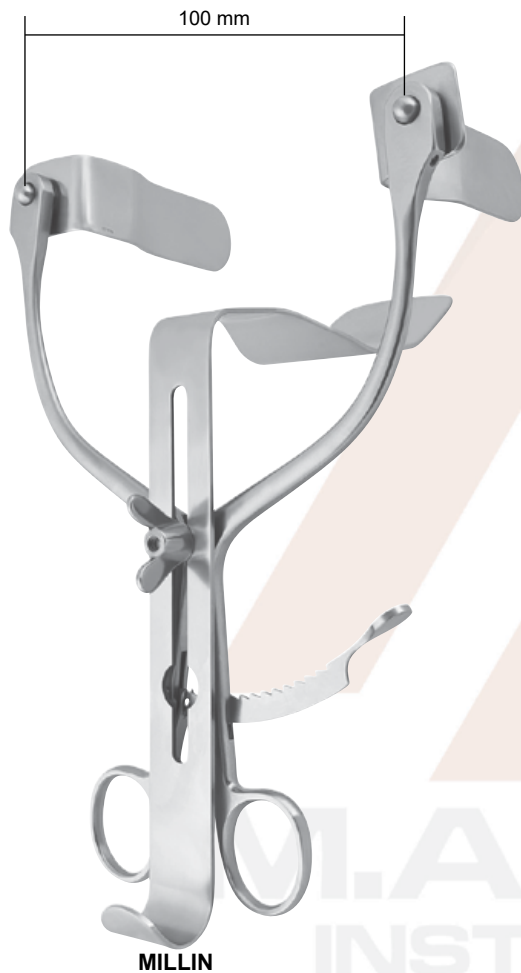
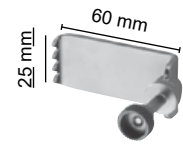

Blasenwundspreizer komplett, bestehend aus:
Bladder retractor complete, consisting of:

MA 6702-00

Sperrer allein
Retractor only

1 Paar Blätter 57 x 25 mm
1 pair of blades 57 x 25 mm

1 Paar Blätter 80 x 25 mm (max. Spreizweite 120 mm)
1 pair of blades, 80 x 25 mm (max. spread 120 mm)

1 Mittelblatt, 110 x 45 mm
1 Central blade, 110 x 45 mm

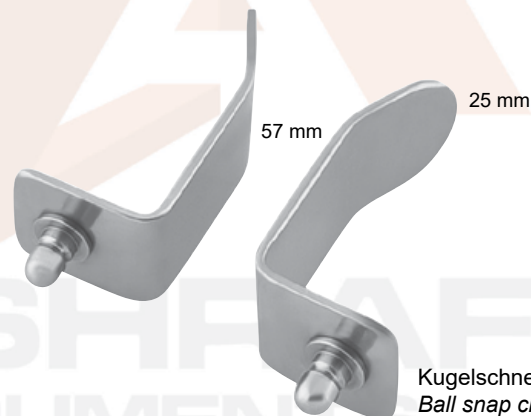

Kugelschnellverschluss
Ball snap closure

Blasenwundspreizer Bladder Retractors

Maßangaben für Mittelblätter
und Blätter

1. Zahl = Länge
2. Zahl = Breite

*Dimensions for central blades
and blades*

1st number = length

2nd number = width

Mittelblatt

Beispiel: 95 x 22 mm

Central blade

Example: 95 x 22 mm

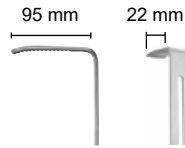

Blätter

Beispiel: 60 x 25 mm

Blades

Example: 60 x 25 mm

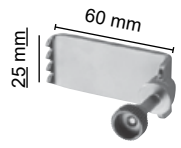

LEGUEU

Blasenwundspreizer komplett, bestehend aus:
Bladder retractor complete, consisting of:

MA 6703-00

Sperrer allein
Retractor only

1 Paar Blätter 62 x 30 mm (max. Spreizweite 70 mm)

1 pair of blades 62 x 30 mm (max. spread 70 mm)

1 Mittelblatt, 85 x 31 mm

1 Central blade, 85 x 31 mm

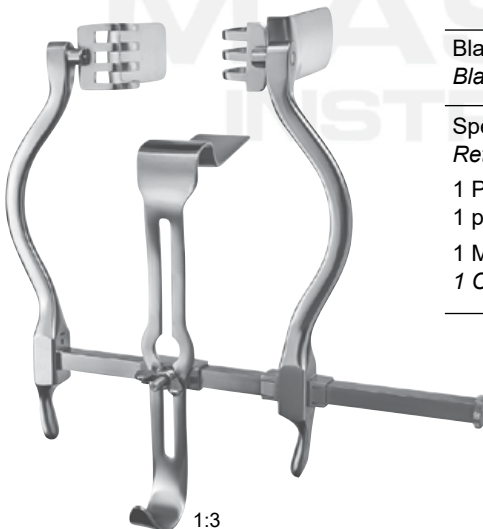

1:3

JUDD-MASSON

Blasenwundspreizer komplett, bestehend aus:
Bladder retractor complete, consisting of:

MA 6706-00

Sperrer allein
Retractor only

1 Paar Blätter 67 x 25 mm (max. Spreizweite 120 mm)

1 pair of blades 67 x 25 mm (max. spread 120 mm)

1 Mittelblatt, 75 x 25 mm

1 Central blade, 75 x 25 mm

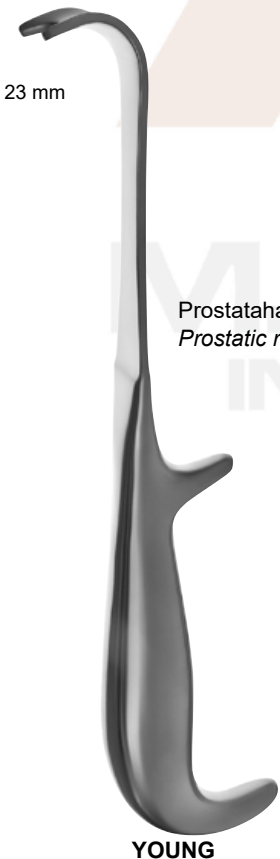
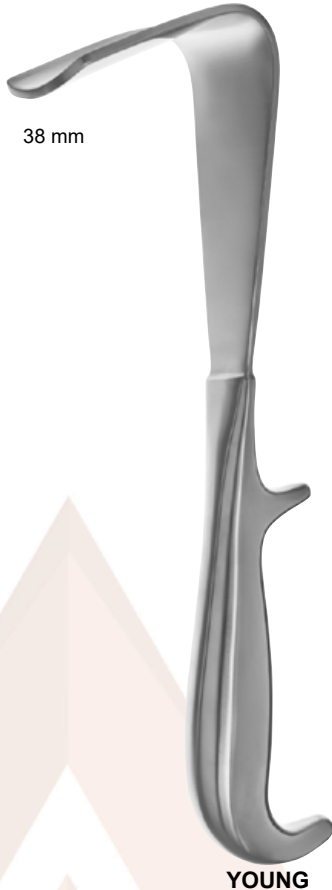

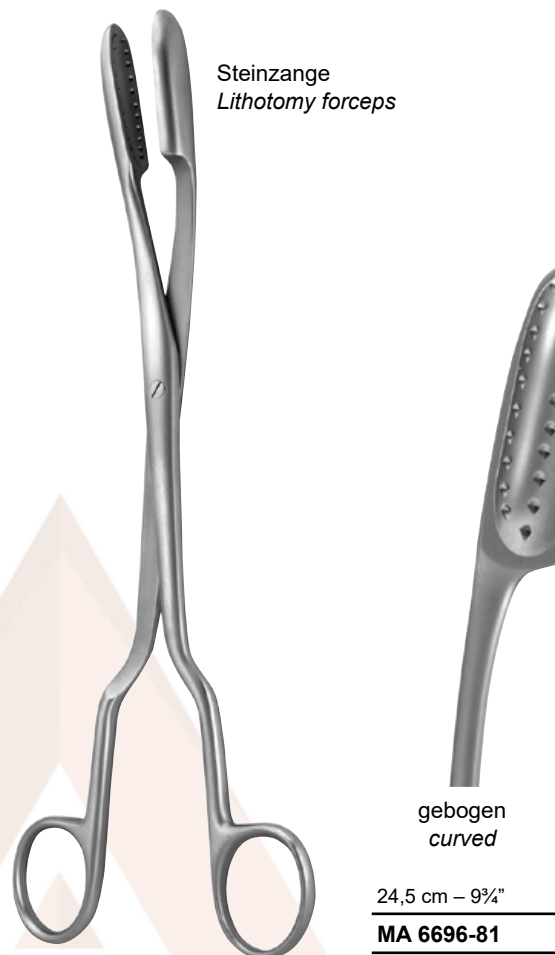



1:3

VAN BURREN

Urethrale Bougies, gebogen
Urethral bougies, curved

Fr. / Charr.	Ø mm	Bèniqùè	27 cm – 10½"
8	2¾	–	MA 6710-08
10	3¾	20	MA 6710-10
12	4	24	MA 6710-12
14	4¾	28	MA 6710-14
16	5¾	32	MA 6710-16
18	6	36	MA 6710-18
20	6¾	40	MA 6710-20
22	7¾	44	MA 6710-22
24	8	48	MA 6710-24
26	8¾	52	MA 6710-26
28	9¾	56	MA 6710-28
30	10	60	MA 6710-30
32	10¾	–	MA 6710-32
34	10¾	–	MA 6710-34
36	12	–	MA 6710-36

Satz à 6 Stück Fr. / Charr. 14-24
in Segeltuchtasche

Set of 6 pieces Fr. / Charr. 14-24
in canvas pocket

MA 6710-51

Satz à 12 Stück Fr. / Charr. 8-24
in Segeltuchtasche

Set of 12 pieces Fr. / Charr. 8-24
in canvas pocket

MA 6710-61



1:3

Metallkatheter für Männer,
gebogen
*Metal catheters for men,
curved*

Fr. / Charr.	Ø mm	29 cm – 11½"
8	2¾	MA 6715-08
10	3¾	MA 6715-10
12	4	MA 6715-12
14	4¾	MA 6715-14



Metallkatheter für Frauen,
gebogen
*Metal catheters for women,
curved*

Fr. / Charr.	Ø mm	16 cm – 6¼"
8	3¾	MA 6716-08
10	3¾	MA 6716-10
12	4	MA 6716-12
14	4¾	MA 6716-14
16	5¾	MA 6716-16
18	6	MA 6716-18

M.ASHRAF
INSTRUMENTS

Katheter-Einführungsinstrument
Catheter guide



39 cm – 15½"
MA 6718-39

1:3
GUYON

Katheter-Einführungsinstrument
Catheter guide



35 cm – 13¾"
MA 6719-35

1:3
GUYON

M.ASHRAF
INSTRUMENTS

Beschneidungsinstrument
Circumcision instrument



7,5 cm – 3"
MA 6723-01

MOGEN

Beschneidungsinstrument
Circumcision instrument



GOMCO

8 mm	MA 6725-08
10 mm	MA 6725-11
13 mm	MA 6725-13
16 mm	MA 6725-16
21 mm	MA 6725-21
26 mm	MA 6725-26
32 mm	MA 6725-32

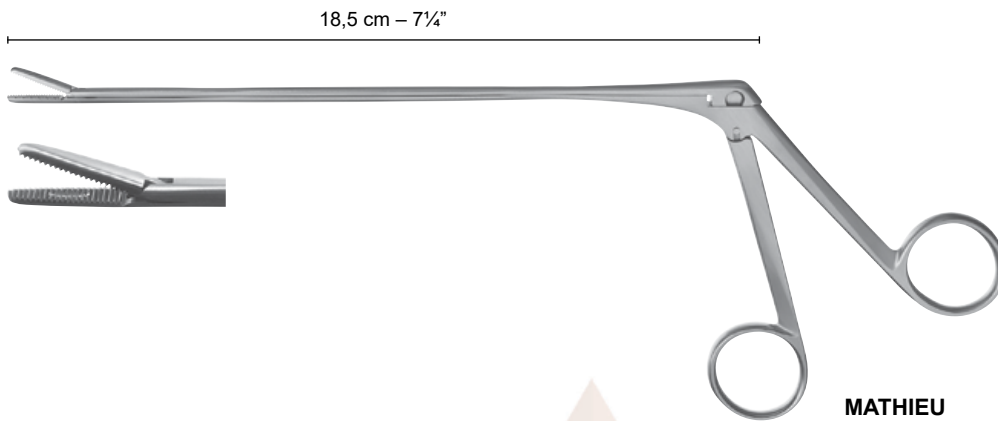

Fremdkörperzange *Foreign body forceps*

MA 6727-20

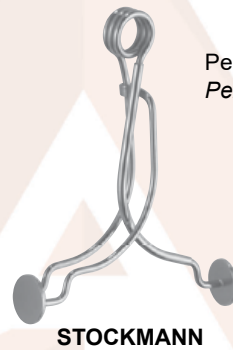

Sekretlöffel, biegsam
Secretion spoon, malleable

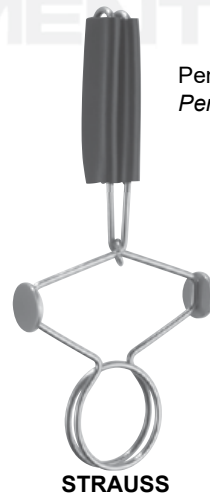

M.ASHRAF
INSTRUMENTS

NINE



Gynäkologie und Geburtshilfe

Gynecology and Obstetrics

Scheidenspekula	<i>Vaginal Specula</i>	GO 1 - 18, 20 - 21
Scheidenhalter	<i>Vaginal Retractors</i>	GO 19
Uterusdilatoren	<i>Uterine Dilators</i>	GO 22
Endospekula für Cervix	<i>Endospecula for Cervix</i>	GO 23
Uterussonden	<i>Uterine Probes</i>	GO 24
Fasszangen	<i>Grasping Forceps</i>	GO 25
Hakenzangen	<i>Uterine Tenaculum Forceps</i>	GO 26 - 32
Polypen- und Ovarienzangen	<i>Polypus- and Ovary Forceps</i>	GO 33 - 34
Uterusfasszangen	<i>Uterine Elevating Forceps</i>	GO 36 - 37
Biopsieinstrumente	<i>Biopsy Instruments</i>	GO 37, 44
Parametriumklemmen	<i>Parametrium Forceps</i>	GO 38 - 40
Hysterektomieklemmen	<i>Hysterectomy Forceps</i>	GO 41 - 42
Vaginalklemmen	<i>Vaginal Forceps</i>	GO 43
Biopsie Küretten	<i>Biopsy Curettes</i>	GO 45
Biopsie Zangen	<i>Biopsy Forceps</i>	GO 46 - 51
Uterus Biopsie Zangen	<i>Uterine Biopsy Forceps</i>	GO 52 - 56
Uteruslöffel	<i>Uterine Scoops</i>	GO 54
Uterusküretten	<i>Uterine Curettes</i>	GO 55 - 57
Biopsie- und Absaugküretten	<i>Biopsy and Aspirating Curettes</i>	GO 58
Salpingograph	<i>Salpingograph</i>	GO 59 - 60
Geburtshilfe	<i>Obstetrics</i>	GO 61 - 62
Geburtszangen	<i>Obstetrical Forceps</i>	GO 63 - 65
Abortuszangen	<i>Ovum Forceps</i>	GO 66
Abortus- und Plazentazangen	<i>Ovum and Placenta Forceps</i>	GO 67
Uterusklemmzangen	<i>Uterine Forceps</i>	GO 68

Scheidenspekula Vaginal Specula

Maßschema für Spekulum
Scheme of dimensions for specula

a	Blattlänge Length of blade
b	Blattbreite Width of blade

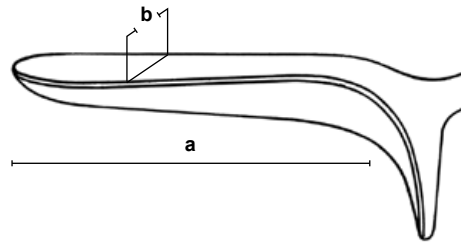

a mm	b mm	für Kinderfor children
65	10	MA 7020-10

M.ASHRAF
INSTRUMENTS

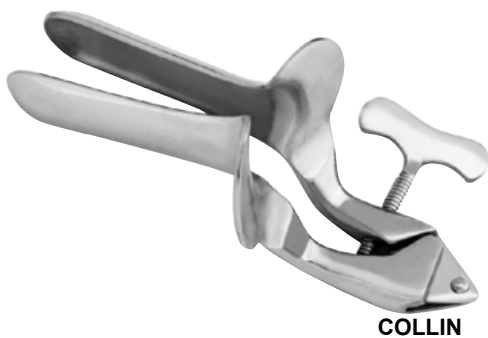

a mm	b mm	für Jungfrauenfor virgins
65	20	MA 7020-11
85	30	MA 7020-01
100	35	MA 7020-02
110	40	MA 7020-03

Scheidenspekula Vaginal Specula

Maßschema für Spekulum
Scheme of dimensions for specula

a	Blattlänge Length of blade
b	Blattbreite Width of blade

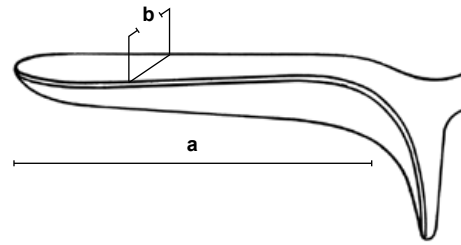

a mm	b mm	für Jungfrauen for virgins
75	17	MA 7002-00

CUSCO

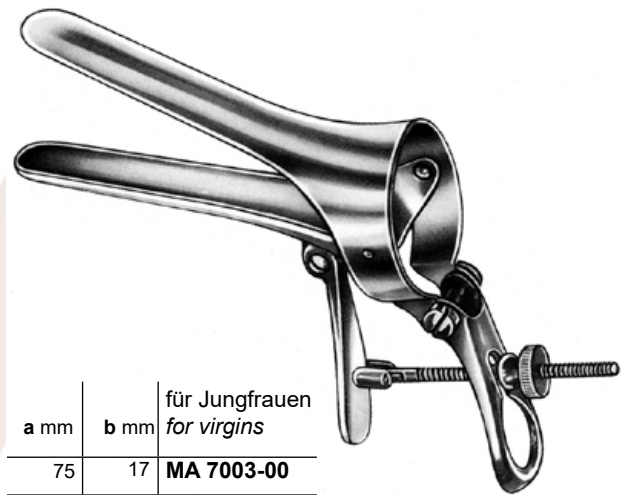

a mm	b mm	für Jungfrauen for virgins
75	17	MA 7003-00

CUSCO



lang und schmal
long and narrow

a mm	b mm	Schweizer Modell Swiss pattern
90	23-25	MA 7004-01
100	25-27	MA 7004-02
110	27-30	MA 7004-03

CUSCO

Scheidenspekula Vaginal Specula

Maßschema für Spekulum
Scheme of dimensions for specula

a	Blattlänge Length of blade
b	Blattbreite Width of blade

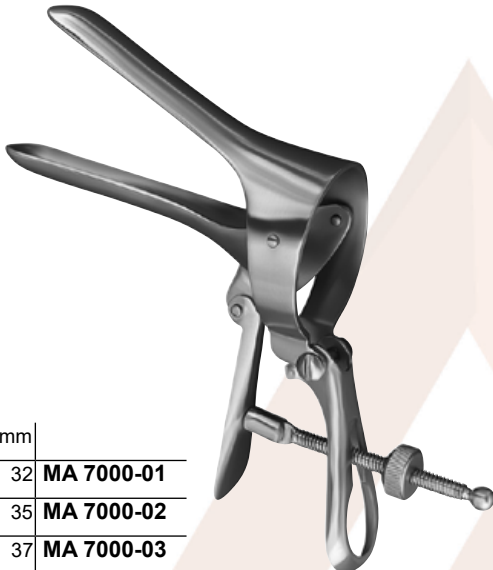
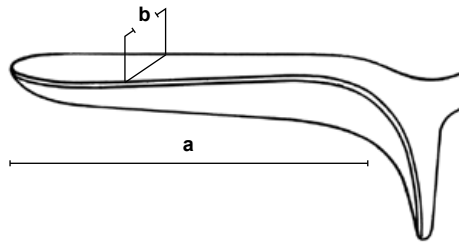

CUSCO

a mm	b mm	
75	32	MA 7000-01
85	35	MA 7000-02
100	37	MA 7000-03

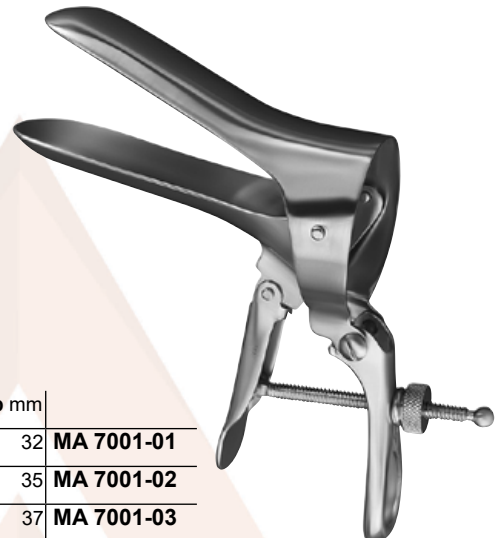

CUSCO

a mm	b mm	
75	32	MA 7001-01
85	35	MA 7001-02
100	37	MA 7001-03

M.ASHRAF
INSTRUMENTS

Scheidenspekula Vaginal Specula

Maßschema für Spekulum
Scheme of dimensions for specula

a	Blattlänge Length of blade
b	Blattbreite Width of blade

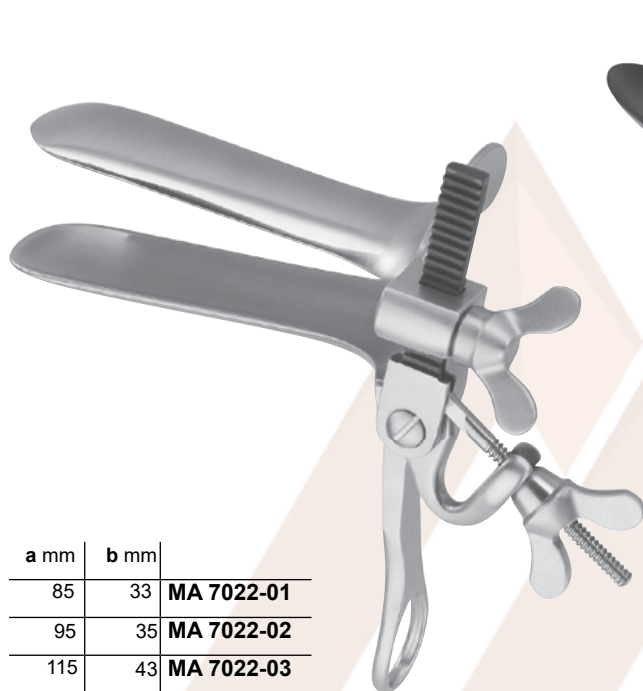
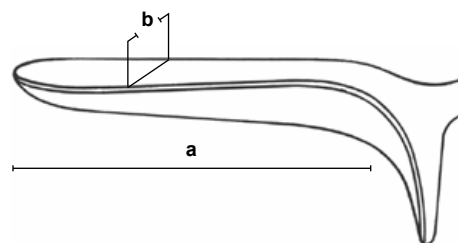

a mm	b mm	
85	33	MA 7022-01
95	35	MA 7022-02
115	43	MA 7022-03

TRELAT



a mm	b mm	abgewinkelt 135° angled 135°
101	35	MA 7023-01

GRAVE

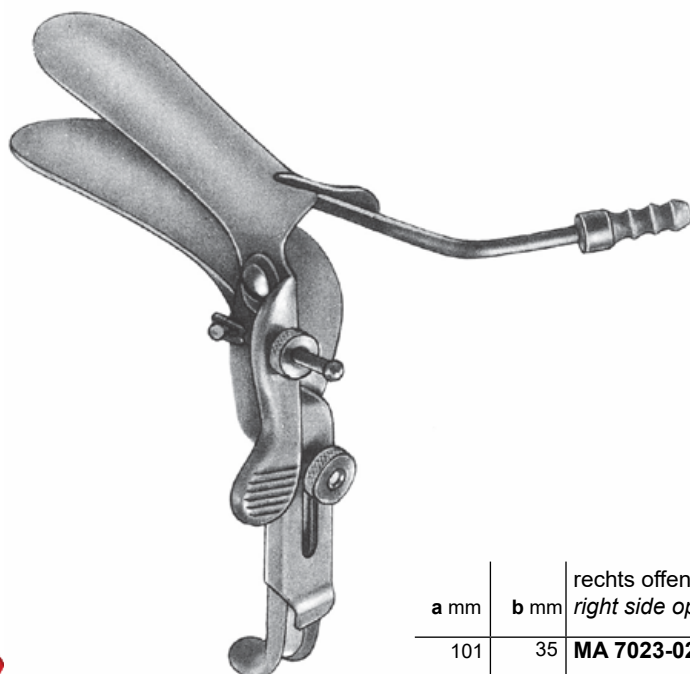

GRAVE

a mm	b mm	rechts offen, abgewinkelt 90° right side open, angled 90°	rechts offen, abgewinkelt 135° right side open, angled 135°
101	35	MA 7023-02	MA 7023-03

Scheidenspekula Vaginal Specula

Maßschema für Spekulum
Scheme of dimensions for specula

a	Blattlänge Length of blade
b	Blattbreite Width of blade

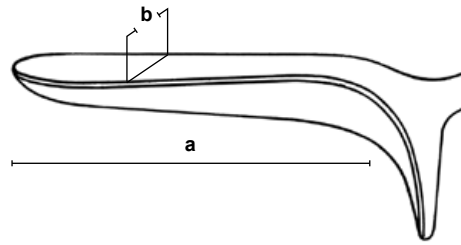

Laser-Spekula
Laser specula



a mm	b mm	
75	20	MA 7024-01
95	30	MA 7024-02
115	35	MA 7024-03

GRAVE

a mm	b mm	
75	20	MA 7025-01
95	30	MA 7025-02
115	35	MA 7025-03
125	35	MA 7025-05

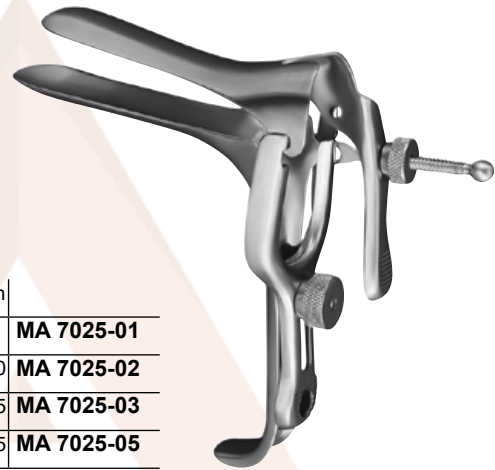

GRAVE



a mm	b mm	
75	13	MA 7026-01
100	22	MA 7026-02
120	25	MA 7026-03

PENDERSON

55 mm
56 x 21 mm



Lateral-Spekulum
Lateral specula

1:3

25,5 cm – 10"
MA 7040-00

Scheidenspekula, Sets Vaginal Specula, Sets

Maßschema für Spekulum
Scheme of dimensions for specula

a	Blattlänge Length of blade
b	Blattbreite Width of blade

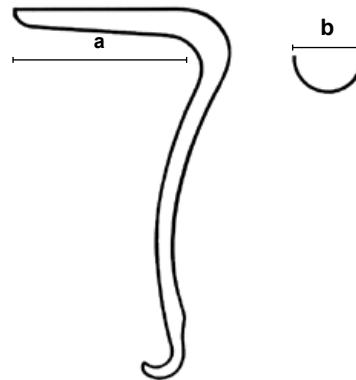

a mm	b mm	
53	32	MA 7049-01
58	32	MA 7049-02
70	38	MA 7049-03

SIMS

Fig.	a mm	b mm	
1	60	25 + 30	MA 7050-01
2	70	30 + 35	MA 7050-02
3	80	35 + 40	MA 7050-03

Satz
Set

MA 7050-00

SIMS

Scheidenspekula, Sets Vaginal Specula, Sets

Maßschema für Spekulum
Scheme of dimensions for specula

a	Blattlänge Length of blade
b	Blattbreite Width of blade

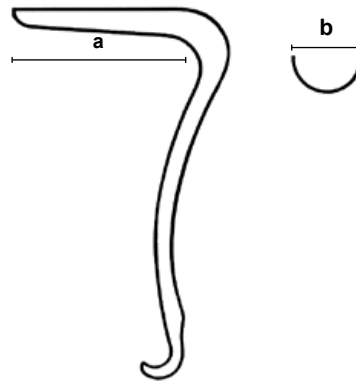

JACKSON

Fig.	a mm	b mm	
1	75	35	MA 7055-01
2	90	35	MA 7055-02
3	100	35	MA 7055-03

Fig.	a mm	b mm	
1	75	38	MA 7056-01
2	90	38	MA 7056-02
3	100	38	MA 7056-03



KALLMORGEN

Scheidenspekulum komplett, bestehend aus: <i>Vaginal specula complete, consisting of:</i>	MA 7078-01
--	-------------------

1 Spekulum Fig. 1, 70 x 40 mm (MA 7078-11)
1 Specula fig. 1, 70 x 40 mm (MA 7078-11)
1 Halter Fig. 1, 70 x 33 mm (MA 7078-21)
1 Retractor fig. 1, 70 x 33 mm (MA 7078-21)

Scheidenspekulum komplett, bestehend aus: <i>Vaginal specula complete, consisting of:</i>	MA 7078-02
--	-------------------

1 Spekulum Fig. 2, 90 x 40 mm (MA 7078-12)
1 Specula fig. 2, 90 x 40 mm (MA 7078-12)
1 Halter Fig. 2, 90 x 33 mm (MA 7078-22)
1 Retractor fig. 2, 90 x 33 mm (MA 7078-22)

Fig.	a mm	b mm	Spekulum Specula
1	70	40	MA 7078-11
2	90	40	MA 7078-12

Fig.	a mm	b mm	Halter Retractor
1	70	33	MA 7078-21
2	90	33	MA 7078-22

Scheidenspekula, Sets Vaginal Specula, Sets

Maßschema für Spekulum
Scheme of dimensions for specula

a	Blattlänge Length of blade
b	Blattbreite Width of blade

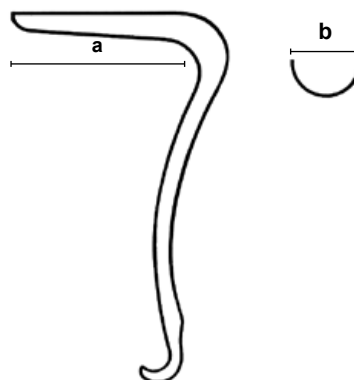

KRISTELLER

Scheidenspekulum für Kinder komplett, bestehend aus: Vaginal specula for children complete, consisting of:	MA 7060-00
1 Spekulum, 70 x 15 mm (MA 7060-30)	
1 Specula, 70 x 15 mm (MA 7060-30)	
1 Halter, 75 x 10 mm (MA 7060-40)	
1 Retractor, 75 x 10 mm (MA 7060-40)	

a mm	b mm	Spekulum Specula
70	15	MA 7060-30

a mm	b mm	Halter Retractor
75	10	MA 7060-40

Scheidenspekula, Sets Vaginal Specula, Sets

Maßschema für Spekulum
Scheme of dimensions for specula

a	Blattlänge Length of blade
b	Blattbreite Width of blade

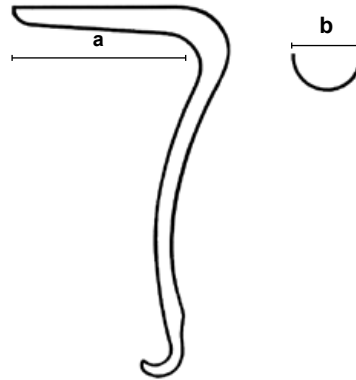

Scheidenspekulum komplett, bestehend aus: <i>Vaginal specula complete, consisting of:</i>	MA 7060-01
--	-------------------

1 Spekulum Fig. 1, 70 x 27 mm (MA 7060-11) 1 Specula fig. 1, 70 x 27 mm (MA 7060-11) 1 Halter Fig. 1, 75 x 23 mm (MA 7060-21) 1 Retractor fig. 1, 75 x 23 mm (MA 7060-21)
--

Scheidenspekulum komplett, bestehend aus: <i>Vaginal specula complete, consisting of:</i>	MA 7060-02
--	-------------------

1 Spekulum Fig. 2, 75 x 30 mm (MA 7060-12) 1 Specula fig. 2, 75 x 30 mm (MA 7060-12) 1 Halter Fig. 2, 80 x 26 mm (MA 7060-22) 1 Retractor fig. 2, 80 x 26 mm (MA 7060-22)
--

Scheidenspekulum komplett, bestehend aus: <i>Vaginal specula complete, consisting of:</i>	MA 7060-03
--	-------------------

1 Spekulum Fig. 3, 90 x 36 mm (MA 7060-13) 1 Specula fig. 3, 90 x 36 mm (MA 7060-13) 1 Halter Fig. 3, 95 x 32 mm (MA 7060-23) 1 Retractor fig. 3, 95 x 32 mm (MA 7060-23)
--

Fig.	a mm	b mm	Spekulum Specula	Fig.	a mm	b mm	Halter Retractor
1	70	27	MA 7060-11	1	75	23	MA 7060-21
2	75	30	MA 7060-12	2	80	26	MA 7060-22
3	90	36	MA 7060-13	3	95	32	MA 7060-23

Scheidenspekula, Sets Vaginal Specula, Sets

Maßschema für Spekulum
Scheme of dimensions for specula

a	Blattlänge Length of blade
b	Blattbreite Width of blade

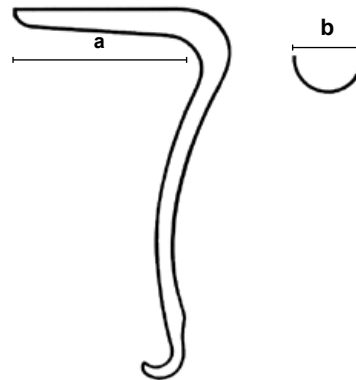

mit konisch verlaufenden
Blättern, für Jungfrauen
with conically shaped
blades, for virgins

Scheidenspekulum komplett, bestehend aus: Vaginal specula complete, consisting of:	MA 7065-01
---	-------------------

1 Spekulum Fig. 00, 110 x 18 mm (MA 7065-11)
1 Specula fig. 00, 110 x 18 mm (MA 7065-11)
1 Halter Fig. 00, 115 x 14 mm (MA 7065-21)
1 Retractor fig. 00, 115 x 14 mm (MA 7065-21)

Scheidenspekulum komplett, bestehend aus: Vaginal specula complete, consisting of:	MA 7065-02
---	-------------------

1 Spekulum Fig. 0, 110 x 21 mm (MA 7065-12)
1 Specula fig. 0, 110 x 21 mm (MA 7065-12)
1 Halter Fig. 0, 115 x 17 mm (MA 7065-22)
1 Retractor fig. 0, 115 x 17 mm (MA 7065-22)

Fig.	a mm	b mm	Spekulum Specula	Fig.	a mm	b mm	Halter Retractor
00	110	18	MA 7065-11	00	115	14	MA 7065-21
0	110	21	MA 7065-12	0	115	17	MA 7065-22

KRISTELLER

Scheidenspekula, Sets Vaginal Specula, Sets

Maßschema für Spekulum
Scheme of dimensions for specula

a	Blattlänge Length of blade
b	Blattbreite Width of blade

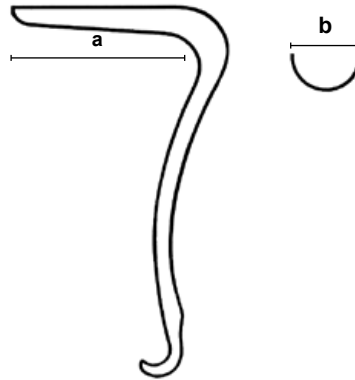

mit besonders
langen Löffeln
with extra
long blades

KRISTELLER

Scheidenspekulum komplett, bestehend aus: <i>Vaginal specula complete, consisting of:</i>	MA 7070-01
1 Spekulum Fig. 1, 110 x 27 mm (MA 7070-11) 1 Specula fig. 1, 110 x 27 mm (MA 7070-11) 1 Halter Fig. 1, 115 x 23 mm (MA 7070-21) 1 Retractor fig. 1, 115 x 23 mm (MA 7070-21)	
Scheidenspekulum komplett, bestehend aus: <i>Vaginal specula complete, consisting of:</i>	MA 7070-02
1 Spekulum Fig. 2, 110 x 30 mm (MA 7070-12) 1 Specula fig. 2, 110 x 30 mm (MA 7070-12) 1 Halter Fig. 2, 115 x 26 mm (MA 7070-22) 1 Retractor fig. 2, 115 x 26 mm (MA 7070-22)	
Scheidenspekulum komplett, bestehend aus: <i>Vaginal specula complete, consisting of:</i>	MA 7070-03
1 Spekulum Fig. 3, 110 x 36 mm (MA 7070-13) 1 Specula fig. 3, 110 x 36 mm (MA 7070-13) 1 Halter Fig. 3, 115 x 32 mm (MA 7070-23) 1 Retractor fig. 3, 115 x 32 mm (MA 7070-23)	

Fig.	a mm	b mm	Spekulum Specula	Fig.	a mm	b mm	Halter Retractor
1	110	27	MA 7070-11	1	115	23	MA 7070-21
2	110	30	MA 7070-12	2	115	26	MA 7070-22
3	110	36	MA 7070-13	3	115	32	MA 7070-23

Scheidenspekula, Sets Vaginal Specula, Sets

Maßschema für Spekulum
Scheme of dimensions for specula

a	Blattlänge Length of blade
b	Blattbreite Width of blade

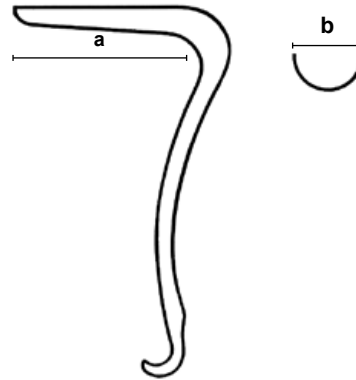

mit abgeflachtem Spekulum
with flattened specula

KRISTELLER

Scheidenspekulum komplett, bestehend aus:
Vaginal specula complete, consisting of: **MA 7072-01**

1 Spekulum Fig. 1, 110 x 27 mm (MA 7072-11)
1 Specula fig. 1, 110 x 27 mm (MA 7072-11)
1 Halter Fig. 1, 115 x 23 mm (MA 7072-21)
1 Retractor fig. 1, 115 x 23 mm (MA 7072-21)

Scheidenspekulum komplett, bestehend aus:
Vaginal specula complete, consisting of: **MA 7072-02**

1 Spekulum Fig. 2, 110 x 30 mm (MA 7072-12)
1 Specula fig. 2, 110 x 30 mm (MA 7072-12)
1 Halter Fig. 2, 115 x 26 mm (MA 7072-22)
1 Retractor fig. 2, 115 x 26 mm (MA 7072-22)

Scheidenspekulum komplett, bestehend aus:
Vaginal specula complete, consisting of: **MA 7072-03**

1 Spekulum Fig. 3, 110 x 36 mm (MA 7072-13)
1 Specula fig. 3, 110 x 36 mm (MA 7072-13)
1 Halter Fig. 3, 115 x 32 mm (MA 7072-23)
1 Retractor fig. 3, 115 x 32 mm (MA 7072-23)

Fig.	a mm	b mm	Spekulum Specula
1	110	27	MA 7072-11
2	110	30	MA 7072-12
3	110	36	MA 7072-13

Fig.	a mm	b mm	Halter Retractor
1	115	23	MA 7072-21
2	115	26	MA 7072-22
3	115	32	MA 7072-23

Scheidenspekula Vaginal Specula

Maßschema für Spekulum
Scheme of dimensions for specula

a	Blattlänge Length of blade
b	Blattbreite Width of blade

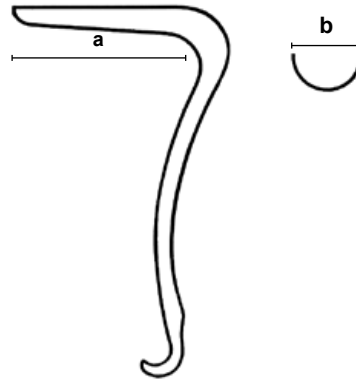

MATZENAUER

a mm	b mm	
100	20	MA 7073-01
100	25	MA 7073-02
100	30	MA 7073-03
100	35	MA 7073-04
100	40	MA 7073-05

a mm	b mm	
130	20	MA 7073-11
130	25	MA 7073-12
130	30	MA 7073-13
130	35	MA 7073-14
130	40	MA 7073-15



BRAUN

a mm	b mm	18 cm – 7"
56	13	MA 7074-00



BRAUN

a mm	b mm	18 cm – 7"
60	10	MA 7075-00

Scheidenspekula Vaginal Specula

Maßschema für Spekulum
Scheme of dimensions for specula

a	Blattlänge Length of blade
b	Blattbreite Width of blade

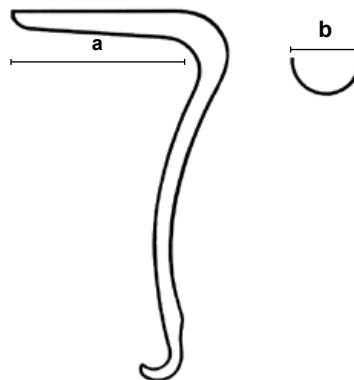

a mm	b mm	19 cm – 7½"
85	17	MA 7077-00

Scheidenspekula Vaginal Specula

Maßschema für Spekulum
Scheme of dimensions for specula

a	Blattlänge Length of blade
b	Blattbreite Width of blade

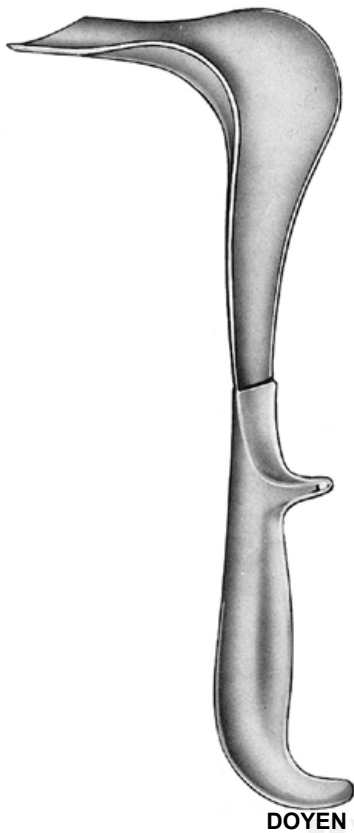
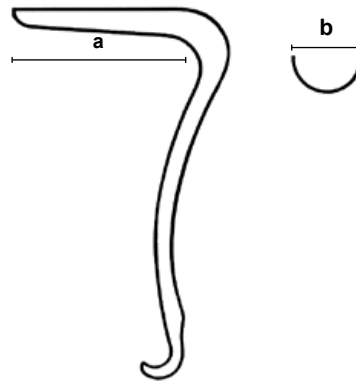
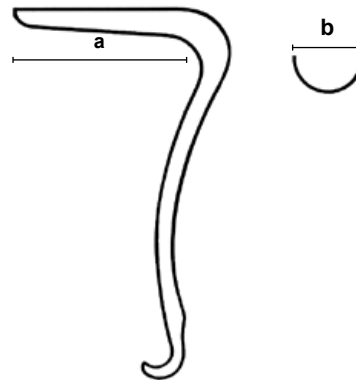

Fig.	a mm	b mm	
1	75	45	MA 7080-11
2	90	45	MA 7080-12
3	110	45	MA 7080-13

Scheidenspekula Vaginal Specula

Maßschema für Spekulum
Scheme of dimensions for specula

a	Blattlänge Length of blade
b	Blattbreite Width of blade



DOYEN

24 cm – 9½"

Fig.	a mm	b mm	leicht hohlslightly-concave
1	55	35	MA 7080-01
2	85	35	MA 7080-02
3	115	35	MA 7080-03

1	55	45	MA 7081-01
2	85	45	MA 7081-02
3	115	45	MA 7081-03
4	160	45	MA 7081-04

1	55	60	MA 7082-01
2	85	60	MA 7082-02
3	115	60	MA 7082-03
4	160	60	MA 7082-04

Scheidenspekula Vaginal Specula

Maßschema für Spekulum
Scheme of dimensions for specula

a	Blattlänge Length of blade
b	Blattbreite Width of blade

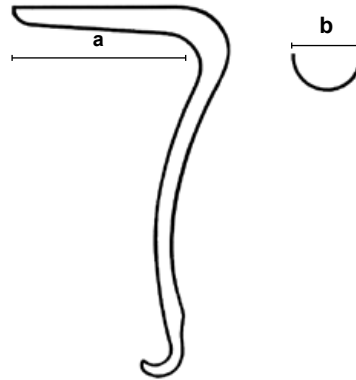

DOYEN

24 cm – 9½"

Fig.	a mm	b mm	halbhohlmedi- um-concave
1	55	35	MA 7083-01
2	85	35	MA 7083-02
3	115	35	MA 7083-03
1	55	45	MA 7084-01
2	85	45	MA 7084-02
3	115	45	MA 7084-03
1	55	60	MA 7085-01
2	85	60	MA 7085-02
3	115	60	MA 7085-03

Scheidenspekula Vaginal Specula

Maßschema für Spekulum
Scheme of dimensions for specula

a	Blattlänge Length of blade
b	Blattbreite Width of blade

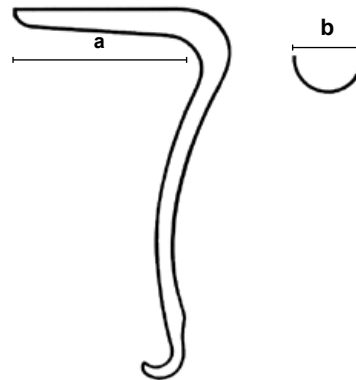

BREISKY

a mm	b mm	
100	20	MA 7090-20
100	25	MA 7090-25
100	30	MA 7090-30
100	35	MA 7090-35
100	40	MA 7090-40
130	20	MA 7091-20
130	25	MA 7091-25
130	30	MA 7091-30
130	35	MA 7091-35
130	40	MA 7091-40
160	20	MA 7092-20
160	25	MA 7092-25
160	30	MA 7092-30
160	35	MA 7092-35
160	40	MA 7092-40
180	20	MA 7093-20
180	25	MA 7093-25
180	30	MA 7093-30
180	35	MA 7093-35
180	40	MA 7093-40

Scheidenhalter Vaginal Retractors

Maßschema für Spekulum
Scheme of dimensions for specula

a	Blattlänge Length of blade
b	Blattbreite Width of blade

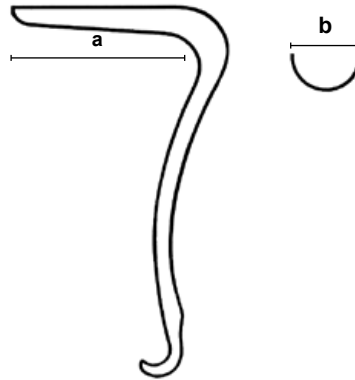

seitliches Spekulum
lateral speculum

DOYEN

a mm	b mm	25 cm – 10"
60	30	MA 7086-01
70	30	MA 7086-02
80	30	MA 7086-25



HÖSEL

	25 cm – 10"
60 x 20 mm	MA 4542-01
80 x 30 mm	MA 4542-02
100 x 30 mm	MA 4542-03
120 x 30 mm	MA 4542-04
140 x 30 mm	MA 4542-05
140 x 40 mm	MA 4542-06

Scheidenspekula Vaginal Specula

Maßschema für Spekulum
Scheme of dimensions for specula

a	Blattlänge Length of blade
b	Blattbreite Width of blade

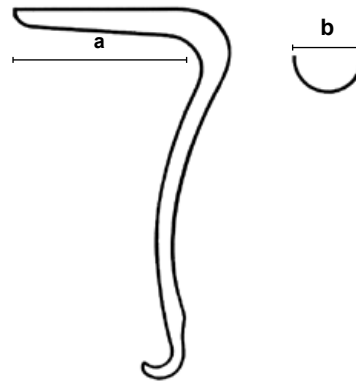

mit abnehmbarem Gewicht
with detachable weight

AUVARDA

1:3

a mm	b mm	
80	38	MA 7088-00
105	42	MA 7088-10



mit festem Gewicht
with fixed weight

AUVARD

1:3

a mm	b mm	
70	38	MA 7088-51
102	45	MA 7088-52

Scheidenspekula Vaginal Specula

Maßschema für Spekulum
Scheme of dimensions for specula

a	Blattlänge Length of blade
b	Blattbreite Width of blade

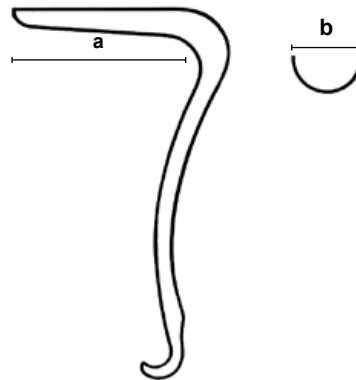

Scheidenspekulum komplett, bestehend aus: Vaginal specula complete, consisting of:	MA 7095-00
1 Griff (MA 7095-14) 1 Handle (MA 7095-14)	
1 Gewicht, leicht, 400 g (MA 7095-10) 1 Weight, light, 400 g (MA 7095-10)	
5 Blätter (1 Stück) (MA 7095-01, -02, -03, -04, -05) 5 Blades (1 piece) (MA 7095-01, -02, -03, -04, -05)	



SCHERBAK



80 x 30 mm

MA 7095-01



85 x 35 mm

MA 7095-02



90 x 40 mm

MA 7095-03

Griff
Handle

MA 7095-14

Gewicht, leicht, 400 g
Weight, light, 400 g

MA 7095-10

Gewicht, schwer, 800 g
Weight, heavy, 800 g

MA 7095-12



55 x 40 / 60 mm

MA 7095-04



70 x 45 / 70 mm

MA 7095-05

Uterusdilatoren Uterine Dilators



Ø mm	
1	MA 7100-01
2	MA 7100-02
3	MA 7100-03
4	MA 7100-04
5	MA 7100-05
6	MA 7100-06
7	MA 7100-07
8	MA 7100-08
9	MA 7100-09
10	MA 7100-10
11	MA 7100-11
12	MA 7100-12
13	MA 7100-13
14	MA 7100-14
15	MA 7100-15

Ø mm	
16	MA 7100-16
17	MA 7100-17
18	MA 7100-18
19	MA 7100-19
20	MA 7100-20
21	MA 7100-21
22	MA 7100-22
23	MA 7100-23
24	MA 7100-24
25	MA 7100-25
26	MA 7100-26
27	MA 7100-27
28	MA 7100-28
29	MA 7100-29
30	MA 7100-30

Ø mm	
1,5	MA 7101-01
2,5	MA 7101-02
3,5	MA 7101-03
4,5	MA 7101-04
5,5	MA 7101-05
6,5	MA 7101-06
7,5	MA 7101-07
8,5	MA 7101-08
9,5	MA 7101-09
10,5	MA 7101-10
11,5	MA 7101-11
12,5	MA 7101-12
13,5	MA 7101-13
14,5	MA 7101-14
15,5	MA 7101-15
16,5	MA 7101-16
17,5	MA 7101-17
18,5	MA 7101-18
19,5	MA 7101-19



Ø mm	
1 / 2	MA 7102-02
3 / 4	MA 7102-04
5 / 6	MA 7102-06
7 / 8	MA 7102-08
9 / 10	MA 7102-10
11 / 12	MA 7102-12
13 / 14	MA 7102-14
15 / 16	MA 7102-16
17 / 18	MA 7102-18
19 / 20	MA 7102-20
21 / 22	MA 7102-22
23 / 24	MA 7102-24
25 / 26	MA 7102-26

Stück per Satz Pieces per set	Satz Set
8 St. / pcs. (3 / 4 – 17 / 18 mm)	MA 7102-30
13 St. / pcs. (1 / 2 – 25 / 26 mm)	MA 7102-40



8 Stück (3 / 4 – 17 / 18 mm) in auskochbarer Rolltasche	MA 7102-50
8 pieces (3 / 4 – 17 / 18 mm) in boilable canvas roll	
Rolltasche, allein Canvas roll, only	MA 7102-51

Endospekula für Cervix
Endospecula for Cervix



GODELL

1:3

34 cm – 13½"

MA 7120-34

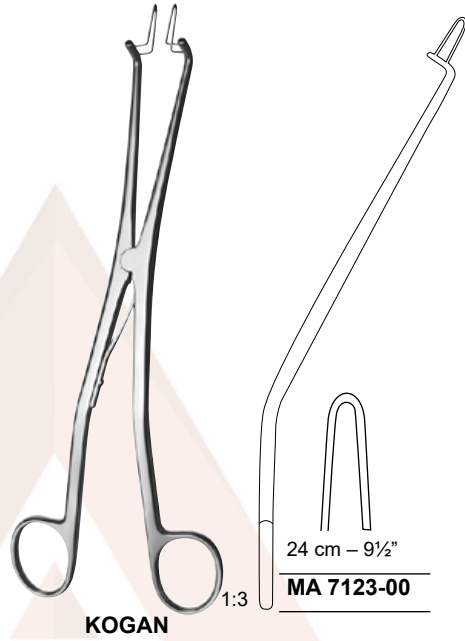

KOGAN

1:3

24 cm – 9½"

MA 7123-00

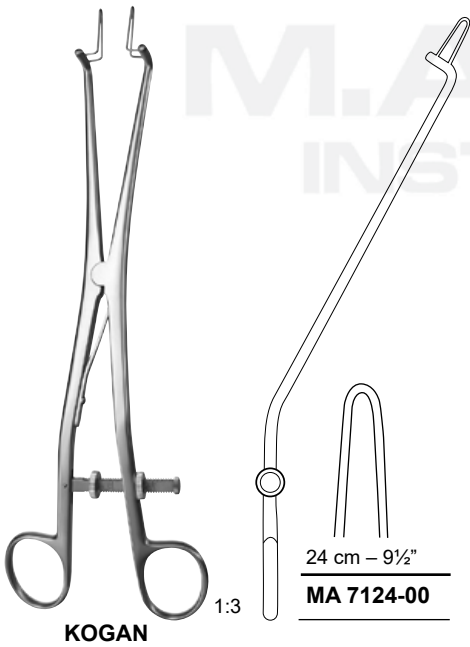

KOGAN

1:3

24 cm – 9½"

MA 7124-00

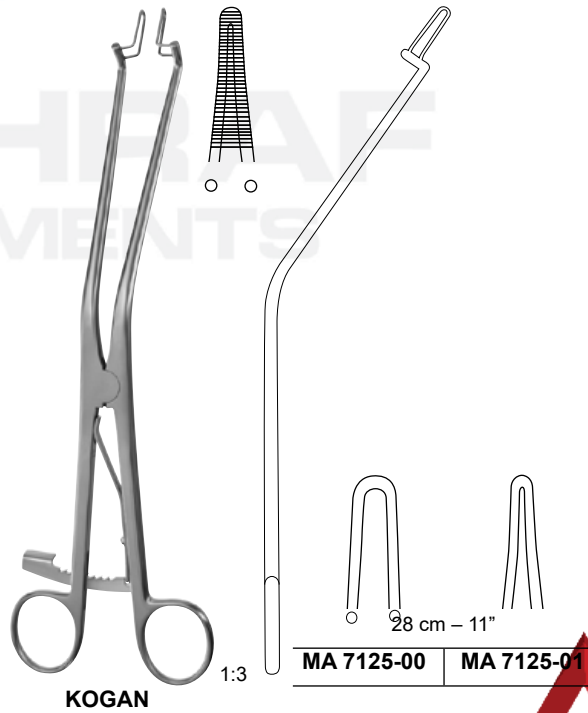

KOGAN

1:3

28 cm – 11"

MA 7125-00

MA 7125-01

Uterussonden Uterine Probes

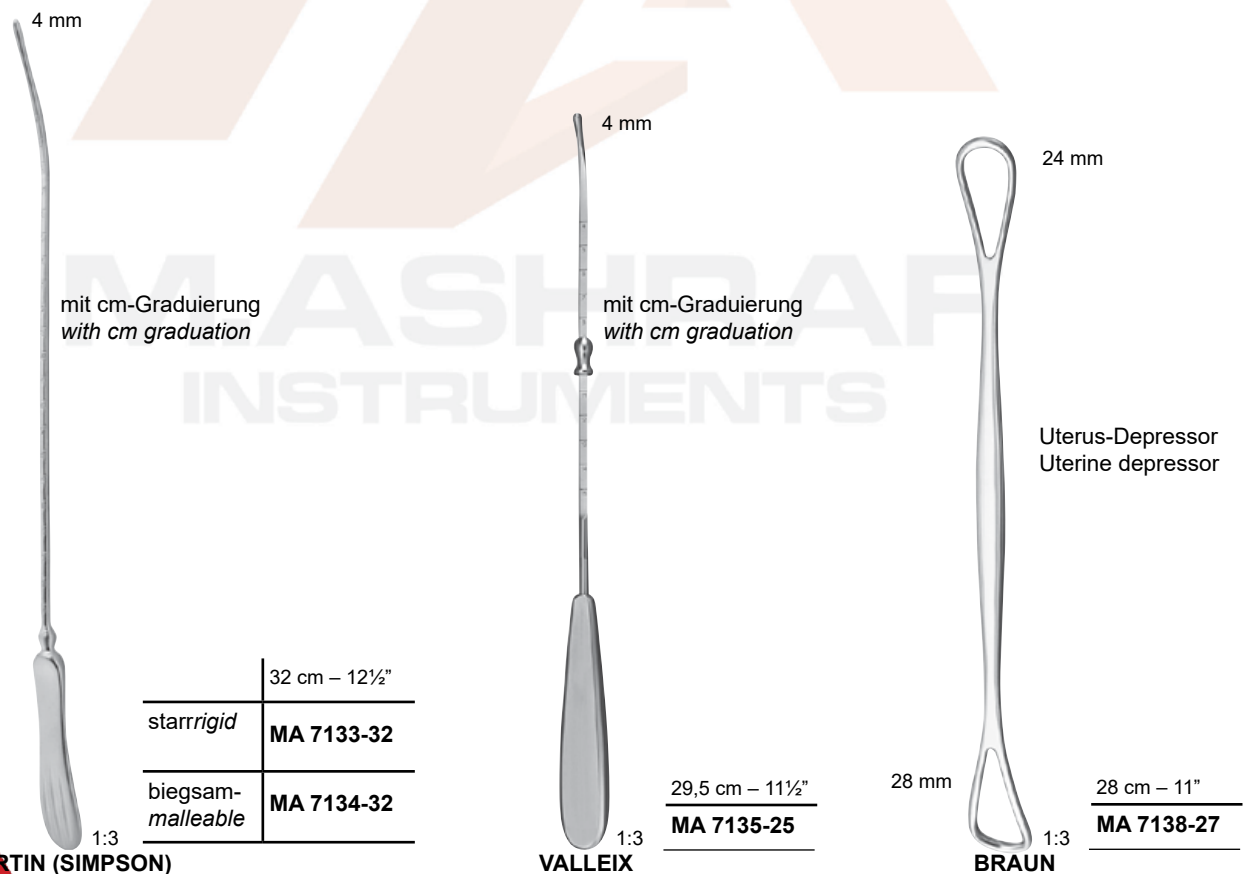
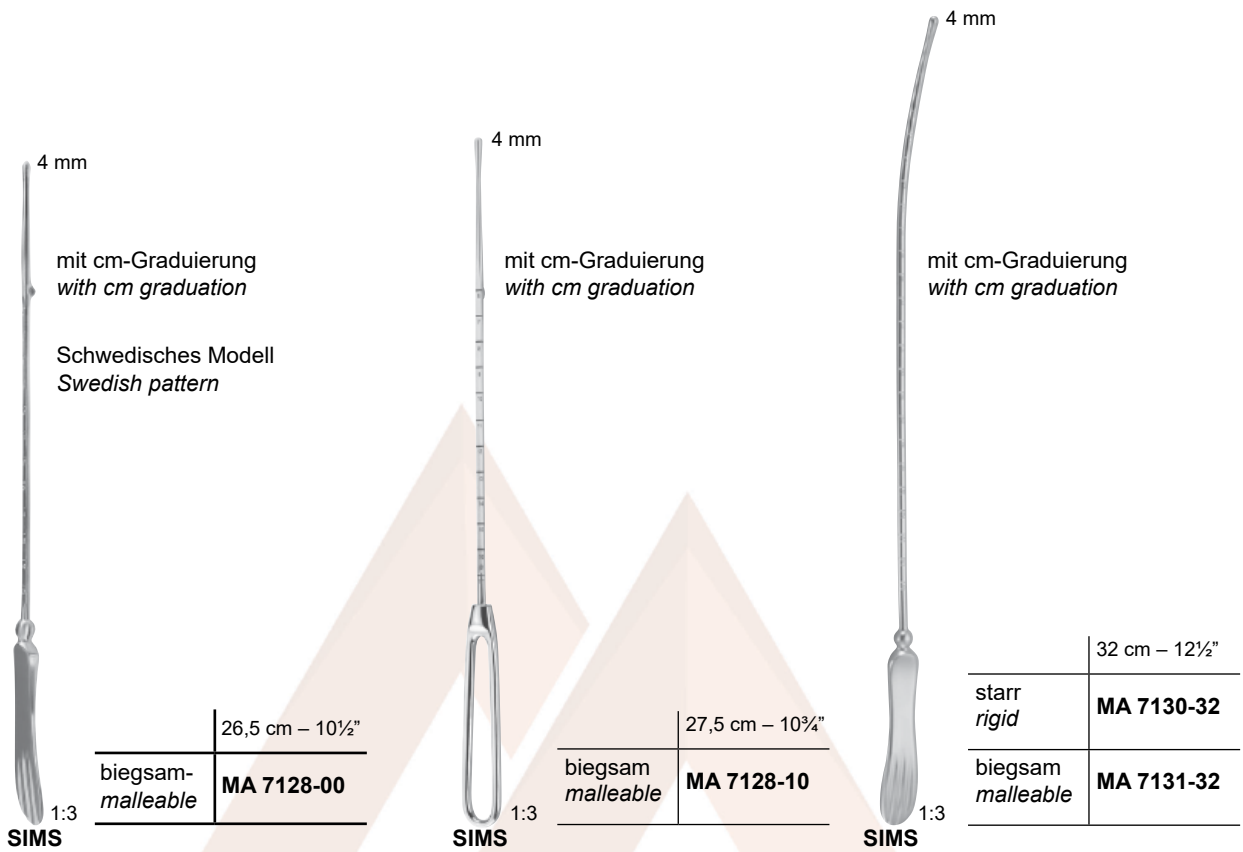

Fasszangen Grasping Forceps



SCHACKE

23 cm – 9"
MA 7150-00



1:3

27 cm – 10½"
MA 7284-00

M.ASHRAF
INSTRUMENTS

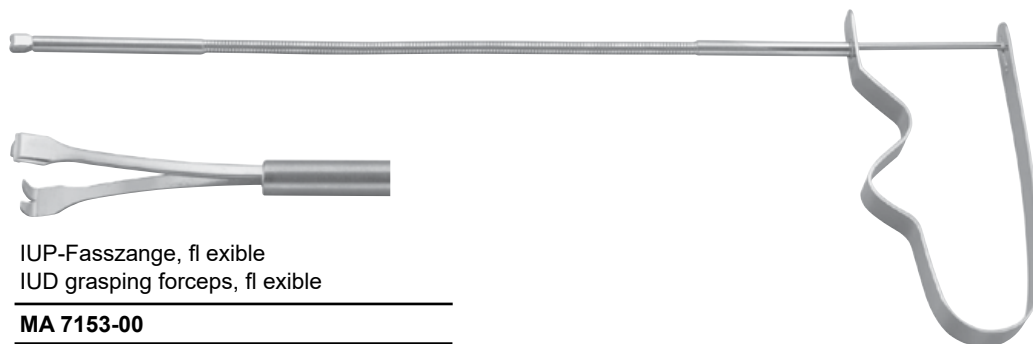

IUP-Fasszange, fl exible
IUD grasping forceps, fl exible

MA 7153-00

Hakenzangen Uterine Tenaculum Forceps



KAHN

24,5 cm – 9¾"
MA 7157-24



MARTIN

27 cm – 10½"
MA 7158-27



BARRETT

18 cm – 7"
MA 7159-03



SCHRÖDER

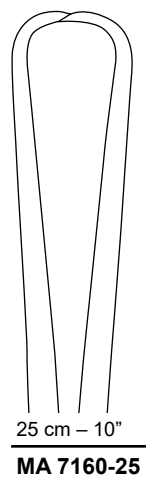

25 cm – 10"
MA 7160-25

Hakenzangen Uterine Tenaculum Forceps

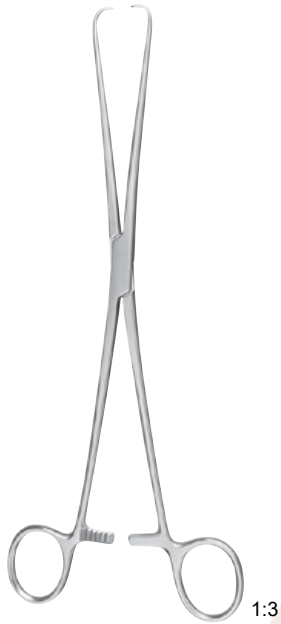

BRAUN

25 cm – 10"
MA 7162-25

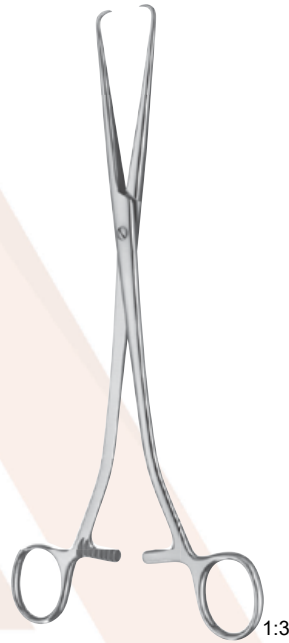

COLLIN-POZZI

25 cm – 10"
MA 7164-25



POZZI

kräftiges Modell
heavy pattern

25,5 cm – 10"
MA 7165-26



DUPLAY

S-gebogen
S-curved

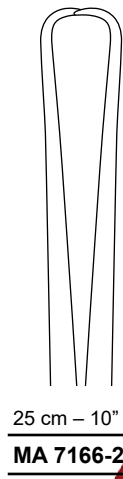

25 cm – 10"
MA 7166-28

Hakenzangen Uterine Tenaculum Forceps



JARCHO



S-gebogen
S-curved

20 cm – 8"

MA 7167-20



SKENE

1:3

24 cm – 9½"

MA 7168-24



BEACHAM

1:3

26 cm – 10¼"

MA 7170-26

Amniotom für das
Amnionmembran
*Amniotome for the
amniotic membrane*



CZERNY

11 mm

20,5 cm – 8"

MA 7175-20

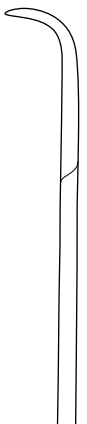

Hakenzangen Uterine Tenaculum Forceps

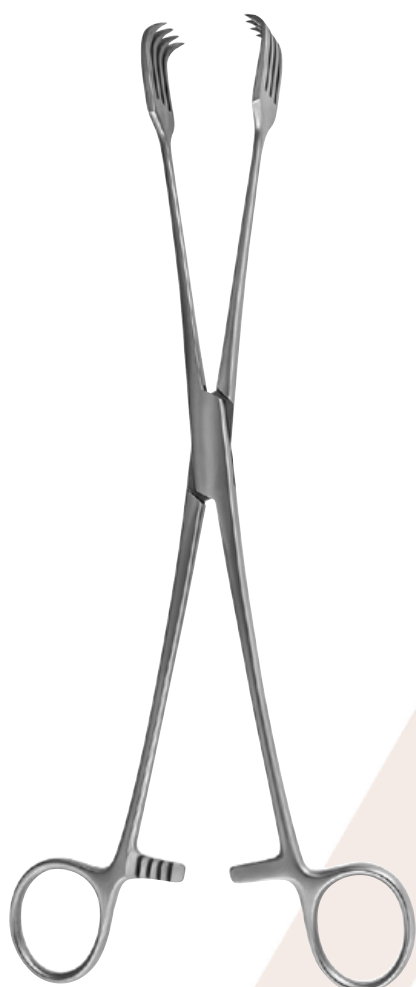

PRATT



26 cm – 10¼"

MA 7178-26



BRAUN

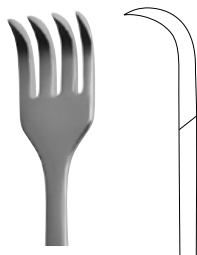

15,5 cm – 6"

MA 7197-16

M.ASHRAF
INSTRUMENTS

Hakenzangen Uterine Tenaculum Forceps



2 : 2 Zähne
2 : 2 teeth

SCHRÖDER



gerade
straight

20 cm – 8"	MA 7180-20
24 cm – 9½"	MA 7180-24



2 : 2 Zähne
2 : 2 teeth

SCHRÖDER



aufgebogen
curved on flat



seitlich gebogen
curved sideways

20 cm – 8"	MA 7181-20	MA 7182-20
24 cm – 9½"	MA 7181-24	MA 7182-24

Hakenzangen Uterine Tenaculum Forceps



MUSEUX



gerade
straight

21 cm – 8¼"

MA 7189-20

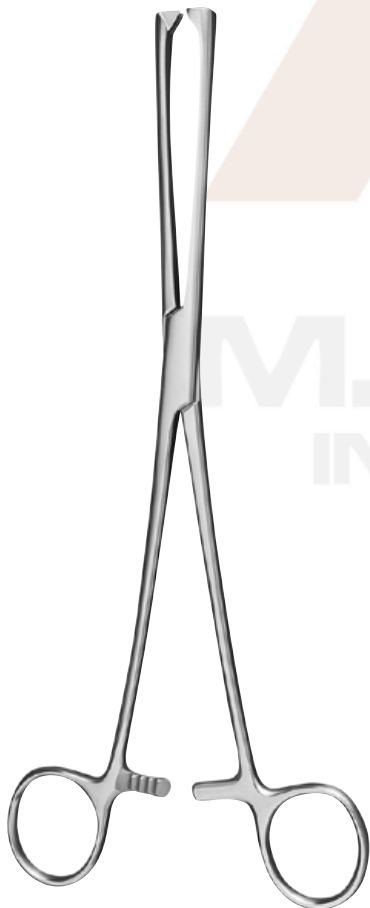

MUSEUX

1:3



gerade
straight

24 cm – 9½"

6 mm

8 mm

10 mm

MA 7190-06

MA 7190-08

MA 7190-10

M.ASHRAF
INSTRUMENTS

Hakenzangen

Uterine Tenaculum Forceps

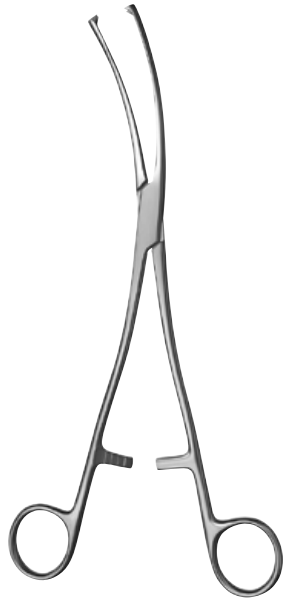

MUSEUX

1:3



seitlich gebogen
curved sideways

24 cm – 9½"

6 mm

8 mm

10 mm

MA 7191-06

MA 7191-08

MA 7191-10



TEALE



3 : 4 Zähne
3 : 4 teeth

seitlich gebogen
curved sideways

23 cm – 9"

MA 7200-23

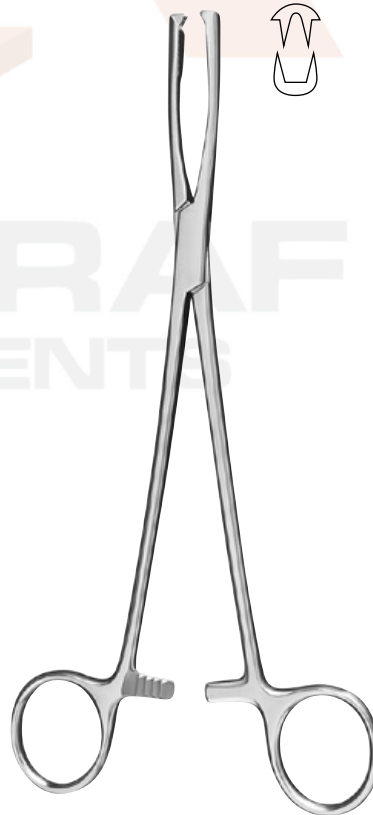

JACOBS



gerade
straight

21 cm – 8¼"

MA 7210-21

Polypen- und Ovarienzangen Polypus and Ovary Forceps



DE LEE

1:3



gerade
straight

24 cm – 9½"

MA 7212-24



VAUT

1:3



aufgebogen
curved on flat

26 cm – 10¼"

MA 7214-26

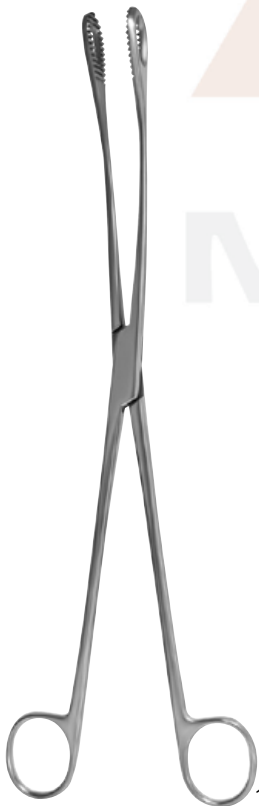

KELLY

1:3



aufgebogen
curved on flat

32 cm – 12½"

MA 7215-32



BONNEY

1:3



gerade
straight

24 cm – 9½"

MA 7216-24

Polypen- und Ovarienzangen Polypus and Ovary Forceps

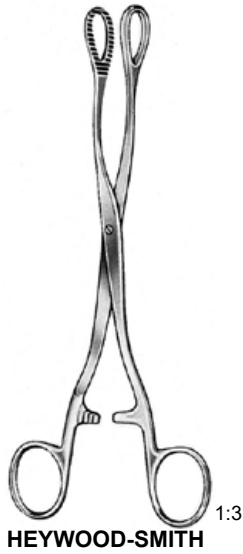

gerade
straight
20 cm – 8"
MA 6616-20



gerade
straight
25 cm – 10"
MA 7218-25



gerade
straight
27 cm – 10½"
MA 7219-27

Uterusfazzangen Uterine Elevating Forceps



DRATIGUES

1:3

27 cm – 10½"

MA 7222-27



SOMER

1:3

23 cm – 9"

MA 7223-23



COLLIN

1:3

mit beweglichen Maulteilen
with moveable jaws

25 cm – 10"

MA 7224-25



COLLIN

1:3

28,5 cm – 11¼"

MA 7225-28

Uterusfasszangen Uterine Elevating Forceps

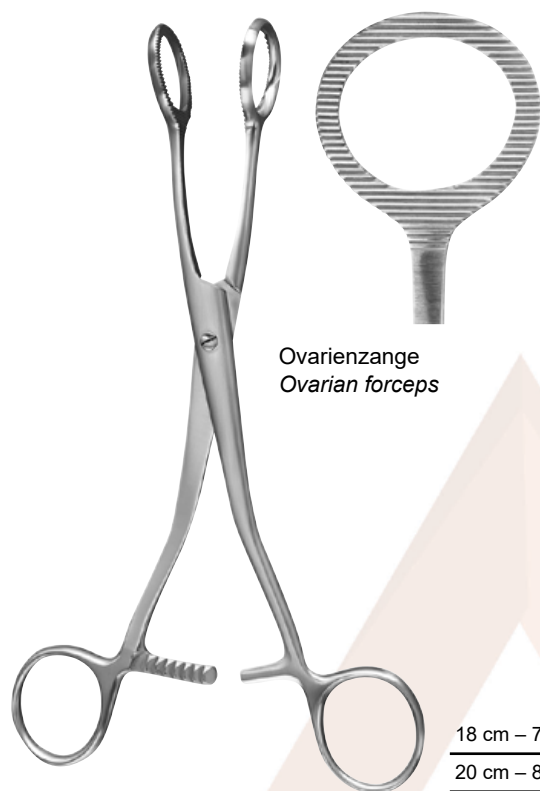

Ovarienszange
Ovarian forceps

DOYEN

18 cm – 7"	MA 7226-18
20 cm – 8"	MA 7226-20

M.ASHRAF
INSTRUMENTS

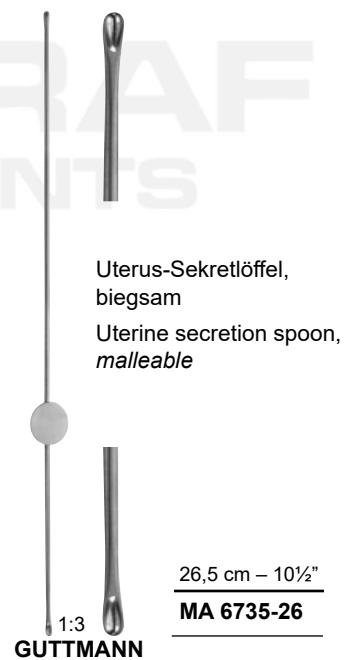
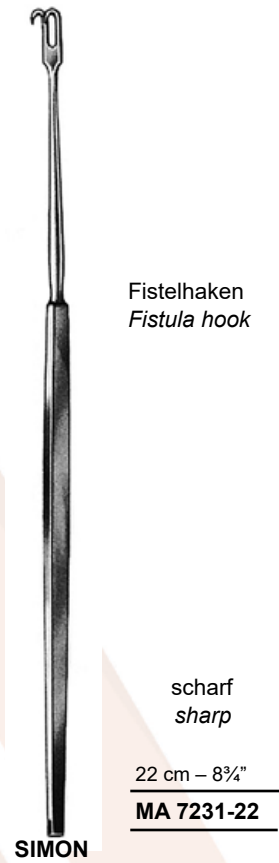
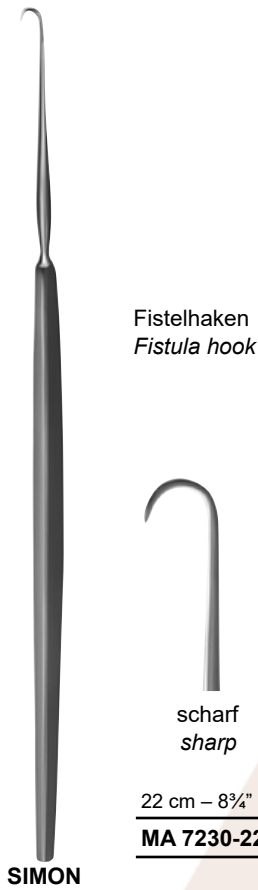

Parametriumklemmen Parametrium Forceps



gerade
straight

22,5 cm – 8¾"

MA 3383-01



leicht gebogen
slightly curved

22 cm – 8¾"

MA 3383-02



stark gebogen
strongly curved

21,5 cm – 8½"

MA 3383-03



gebogen
curved

20,5 cm – 8"

MA 3383-04



DE BAKEY Zahnung
DE BAKEY Serration



gerade
straight

25 cm – 10"

MA 3383-51



leicht gebogen
slightly curved

24,5 cm – 9¾"

MA 3383-52



stark gebogen
strongly curved

24 cm – 9½"

MA 3383-53



ROGERS



gebogen
curved

23 cm – 9"

MA 3383-54

Parametriumklemmen Parametrium Forceps

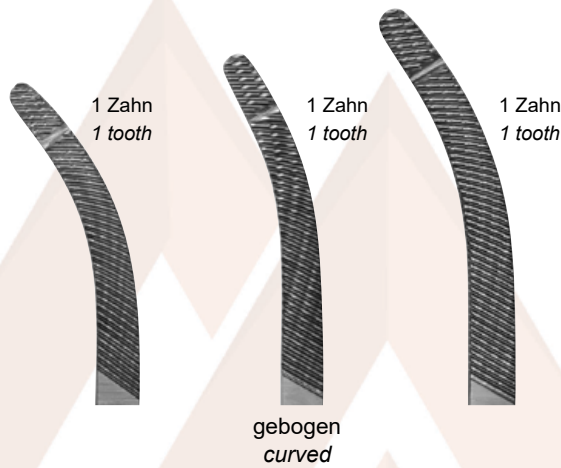

20 cm – 8"	21 cm – 8¼"	23 cm – 9"
MA 3384-19	MA 3384-21	MA 3384-23



20 cm – 8"	21 cm – 8¼"	23 cm – 9"
MA 3385-19	MA 3385-21	MA 3385-23

Parametriumklemmen Parametrium Forceps



HEANEY-SLIM

1 Zahn
1 tooth

gebogen
curved

21 cm – 8¼"

MA 3384-41

M.ASHRAF
INSTRUMENTS

Hysterektomieklemmen Hysterectomy Forceps

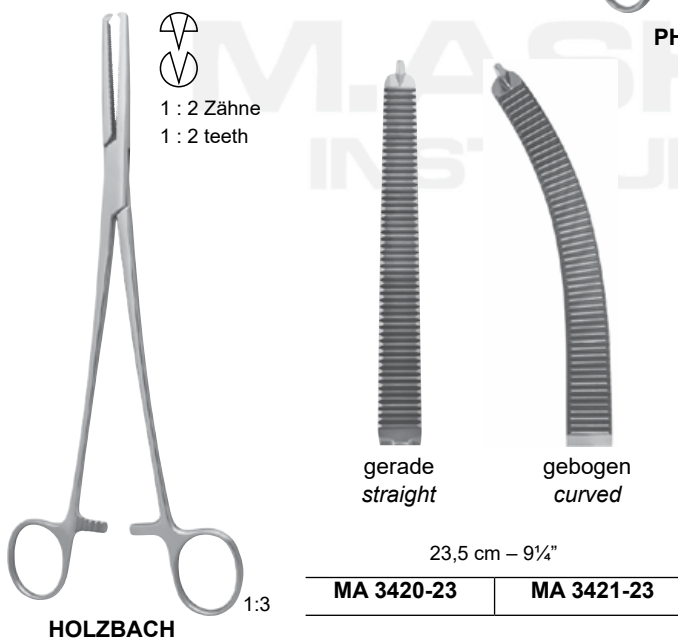
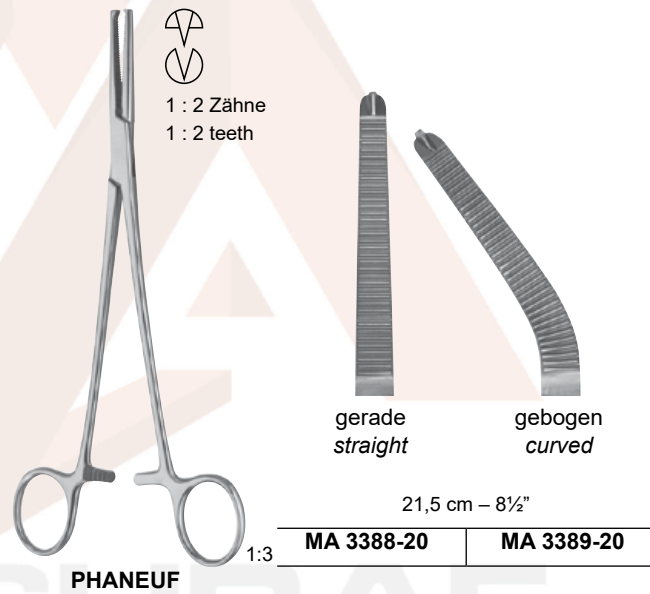
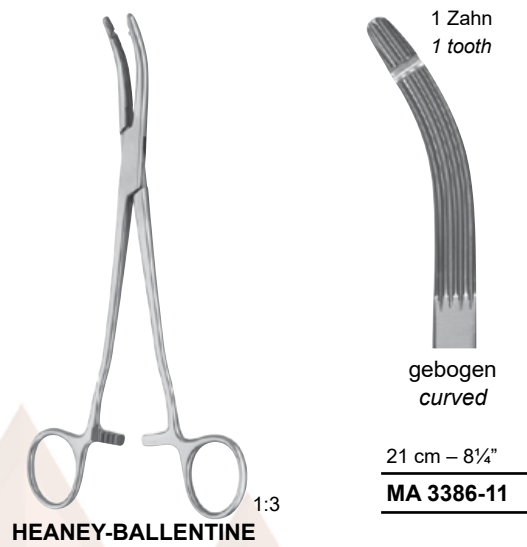
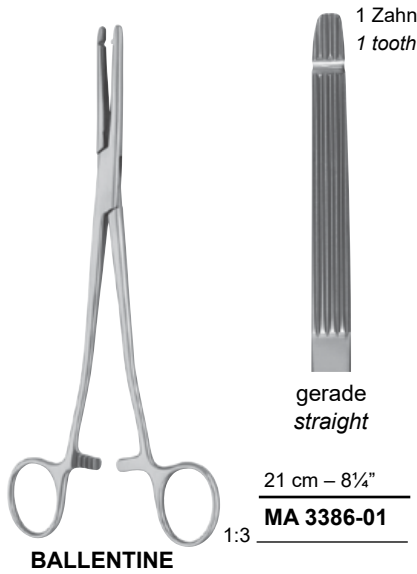

Hysterektomieklemmen Hysterectomy Forceps



WERTHEIM

1:3



gebogen
curved

25 cm – 10"

MA 3430-25



WERTHEIM-CULLEN



90°

gebogen
curved

21,5 cm – 8½"

MA 3432-21



WERTHEIM

1:3



gebogen
curved

24 cm – 9½"

MA 3433-24



1 : 2 Zähne
1 : 2 teeth

extra stark
extra strong



WERTHEIM

1:3



1 : 2 Zähne
1 : 2 teeth



leicht gebogen
slightly curved



gebogen
curved

22 cm – 8¾"

MA 3435-22

MA 3436-22

Vaginalklemmen Vaginal Forceps

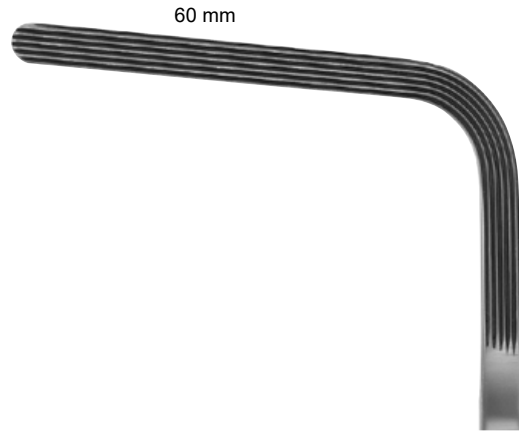

60 mm

23 cm – 9"

MA 3434-01

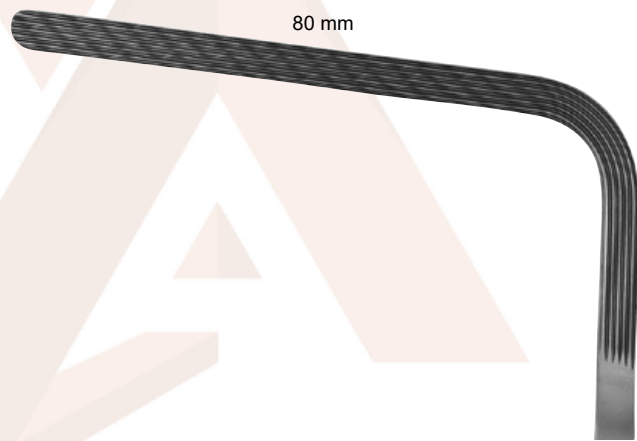

80 mm

23 cm – 9"

MA 3434-02

M.ASHRAF
INSTRUMENTS

Biopsieinstrumente Biopsy Instruments

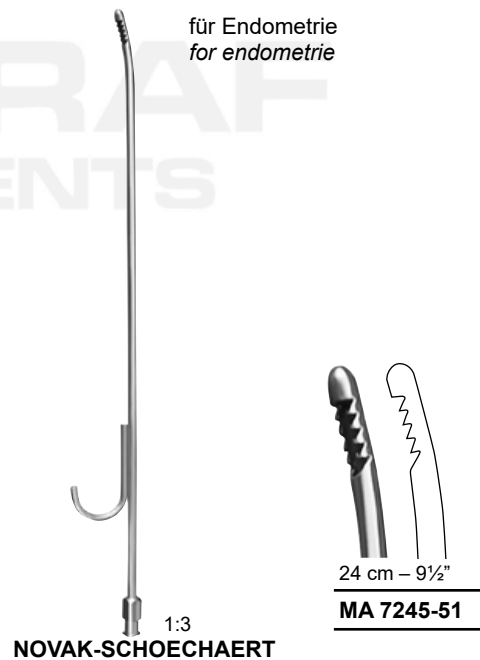
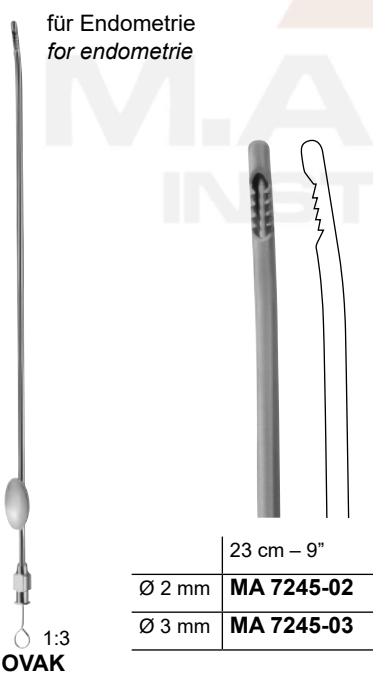
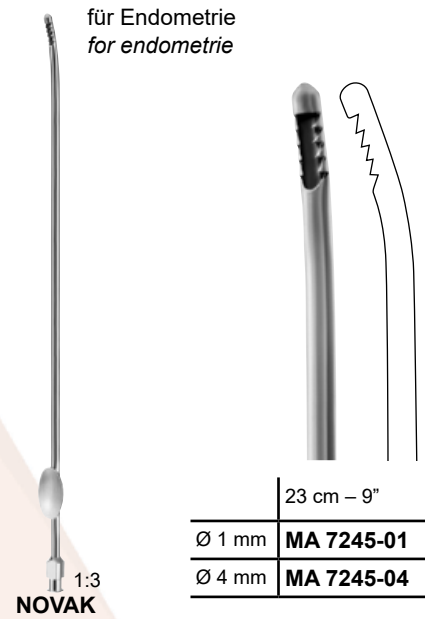

Biopsieküretten Biopsy Currettes

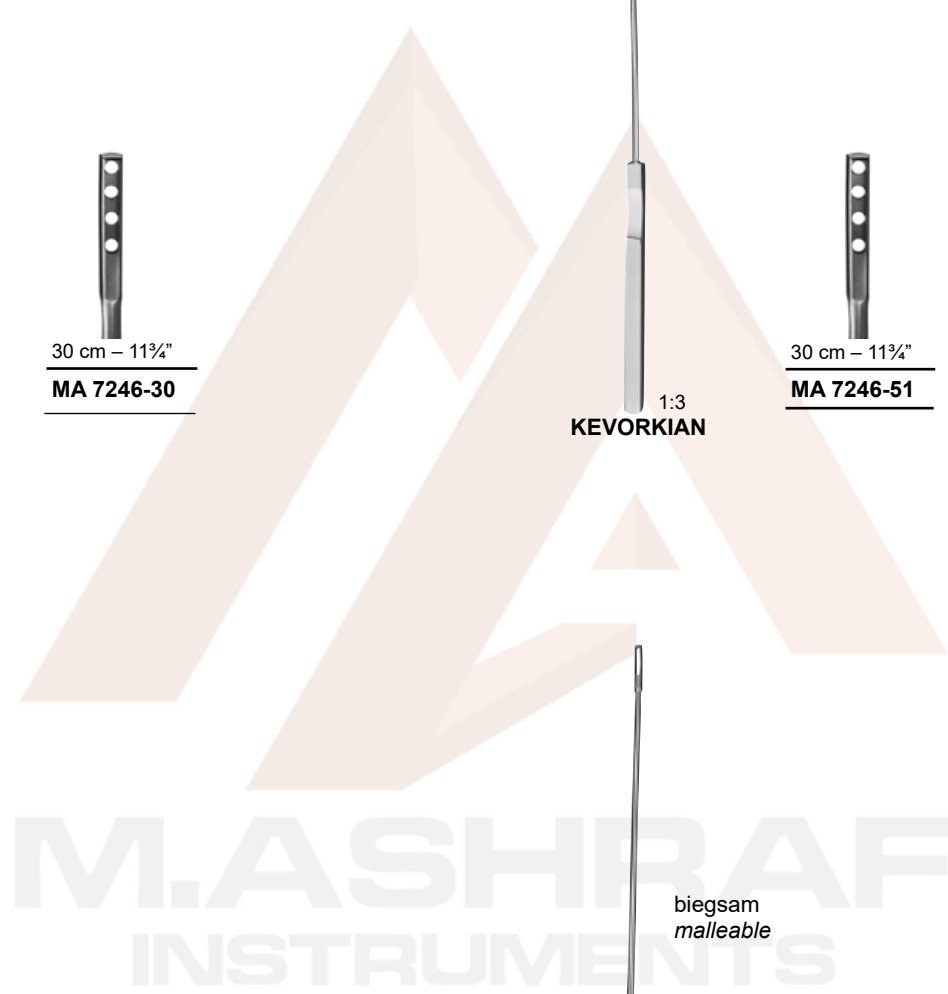
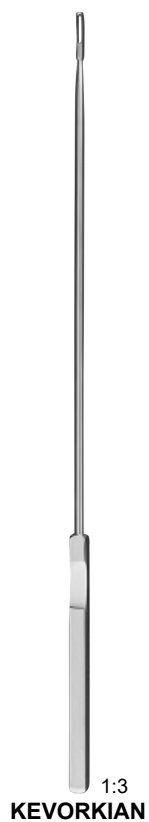
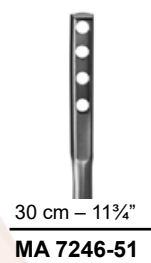
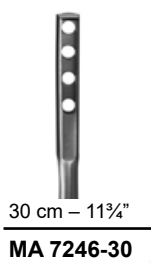

biegsam
malleable

M.ASHRAF
INSTRUMENTS

Biopsiezangen Biopsy Forceps

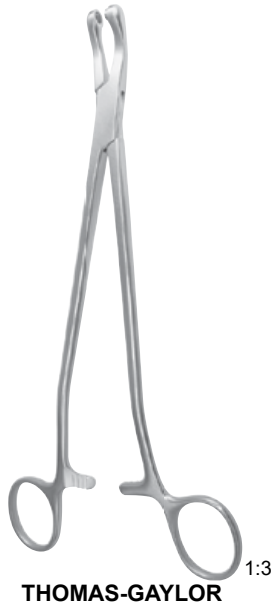

24 cm – 9½"

MA 7252-24

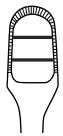

21 cm – 8¼" **MA 7255-21**

29 cm – 11½" **MA 7255-29**

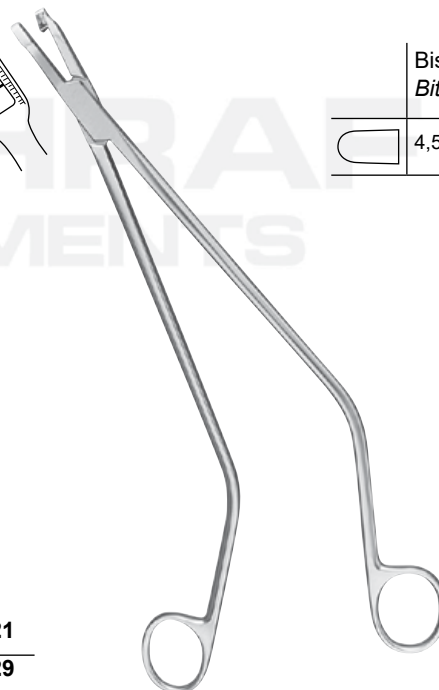

Bissbreite
Bite width

4,5 x 8 mm



1:3 26 cm – 10¼"

MA 7256-26

Biopsiezangen Biopsy Forceps



TISCHLER

1:3

27 cm – 10½"

MA 7257-27

Bissbreite Bite width	
	4 x 7 mm



VAN DOREN

1:3

25 cm – 10"

MA 7258-01

Bissbreite Bite width	
	3,5 / 4 x 7 mm

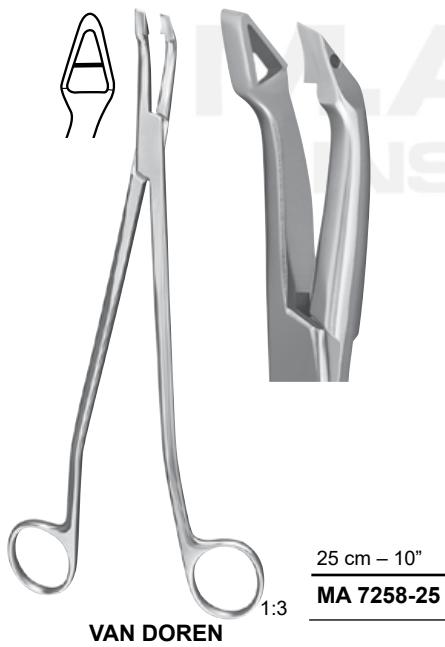

VAN DOREN

1:3

25 cm – 10"

MA 7258-25



SCHUMACHER

1:3



24 cm – 9½"

Fig. 1

Fig. 2

MA 7261-24

MA 7262-24

Biopsiezangen
Biopsy Forceps



FAURE

21 cm – 8¼"

MA 7263-21

M.ASHRAF
INSTRUMENTS

Biopsiezangen Biopsy Forceps

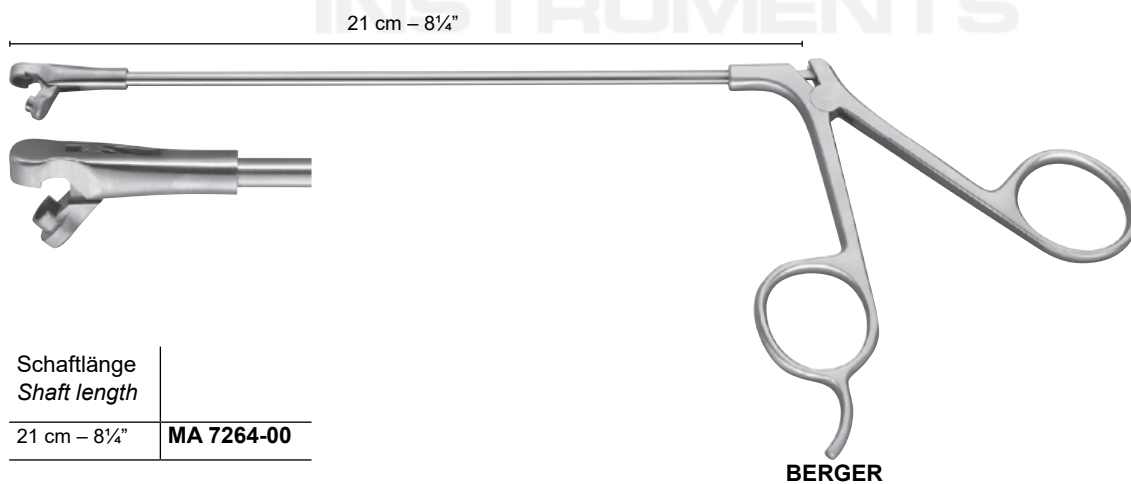
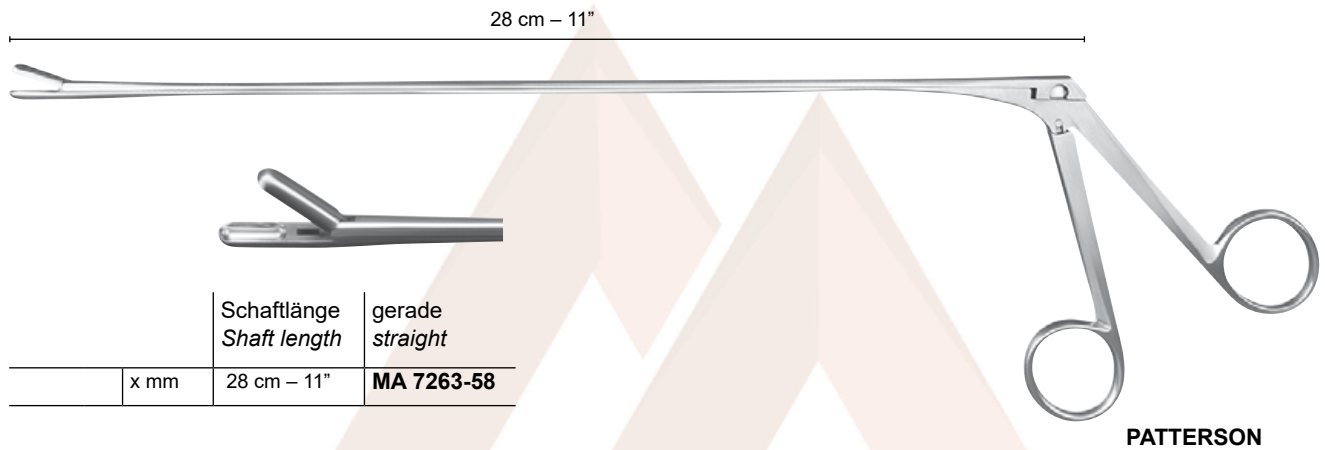

M.ASHRAF
INSTRUMENTS



Biopsiezangen Biopsy Forceps

Schaftlänge
Shaft length



	Bissbreite Bite width	Schaftlänge Shaft length	DOUAY
	4 x 10 mm	20 cm – 8"	MA 7264-20
		25 cm – 10"	MA 7264-25
		30 cm – 11¼"	MA 7264-30

	Bissbreite Bite width	Schaftlänge Shaft length	EPPENDORF
	4 x 8 mm	20 cm – 8"	MA 7267-00
			MA 7267-00P

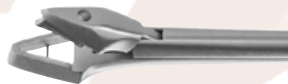

	Schaftlänge Shaft length	Bissbreite Bite width	SCHUMACHER
	24 cm – 9½"	4 mm	MA 7265-00
	24 cm – 9½"	4 mm	MA 7265-00P
	24 cm – 9½"	6 mm	MA 7265-06
	24 cm – 9½"	6 mm	MA 7265-06P

	Bissbreite Bite width	Schaftlänge Shaft length	KEVORKIAN
	3 x 8 mm	24 cm – 9½"	MA 7266-00
			MA 7266-00P

ProClean = verbesserte Reinigung dank zerlegbarem Schiebeschaf
Erkennungsmerkmal: zusätzlich endet die Artikelnummer mit dem Buchstaben „P“

ProClean = improved cleaning by dismountable sliding sheath
Identifying feature: additionally the article number ends with the letter "P"

Biopsiezangen Biopsy Forceps

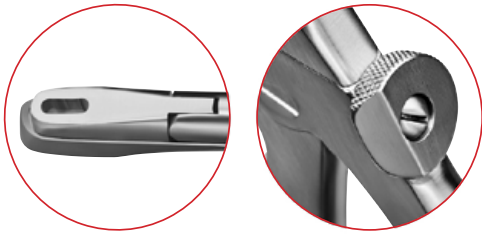

Verriegelung, geschlossen
Lock, locked

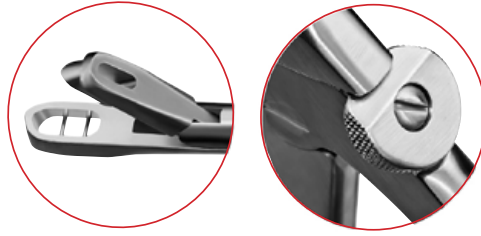

Verriegelung, offen
Lock, unlocked

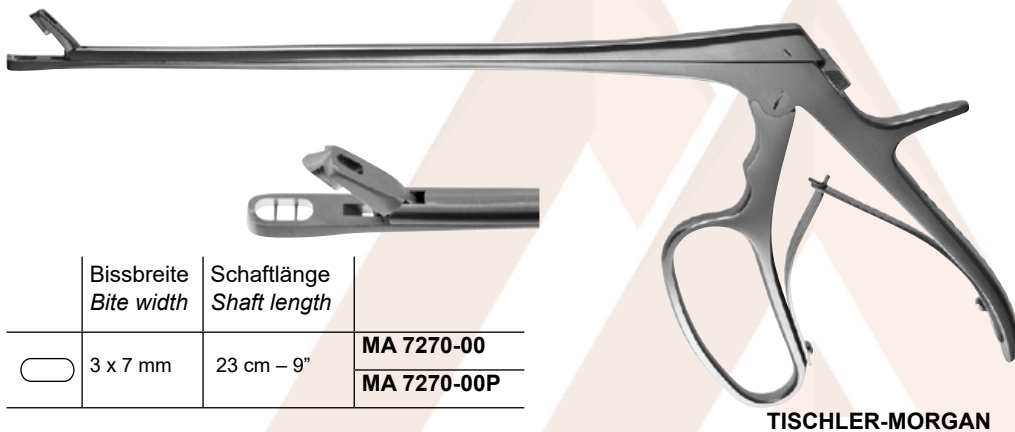

TISCHLER-MORGAN

	Bissbreite Bite width	Schaftlänge Shaft length	
	3 x 7 mm	23 cm – 9"	MA 7270-00 MA 7270-00P



BABY-TISCHLER

	Bissbreite Bite width	Schaftlänge Shaft length	
	2,3 x 6,5 mm	21 cm – 8¼"	MA 7270-50 MA 7270-50P

Uterus-Biopsiezangen Uterine Biopsy Forceps

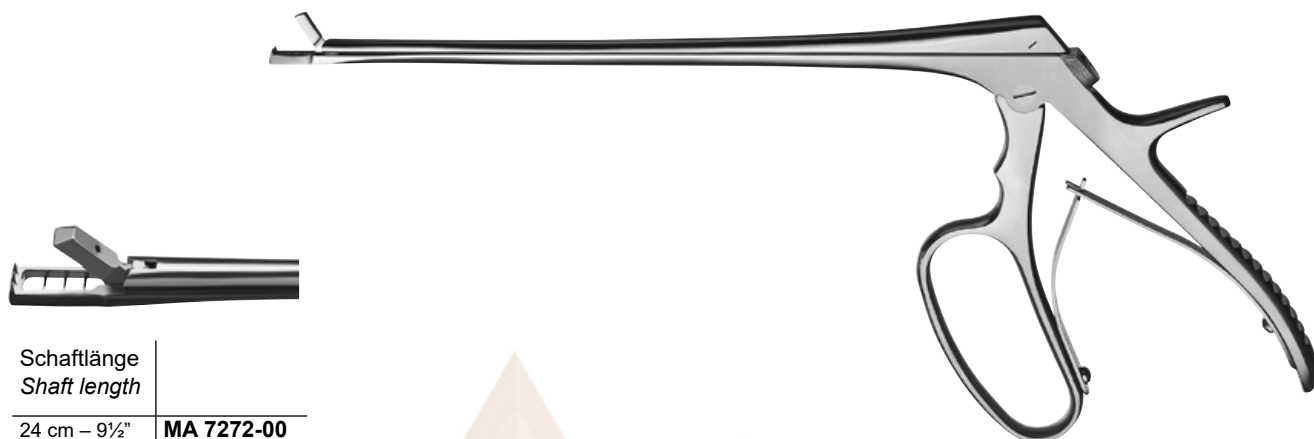

Schaftlänge Shaft length	
24 cm – 9½"	MA 7272-00

PACIFIC-KEVORKIAN

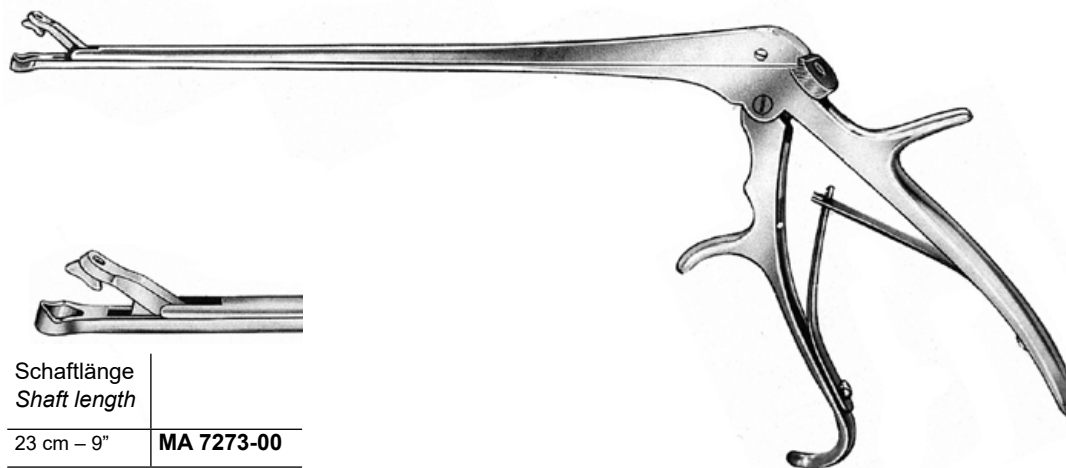

Schaftlänge Shaft length	
23 cm – 9"	MA 7273-00

BURKE

M.ASHRAF
INSTRUMENTS

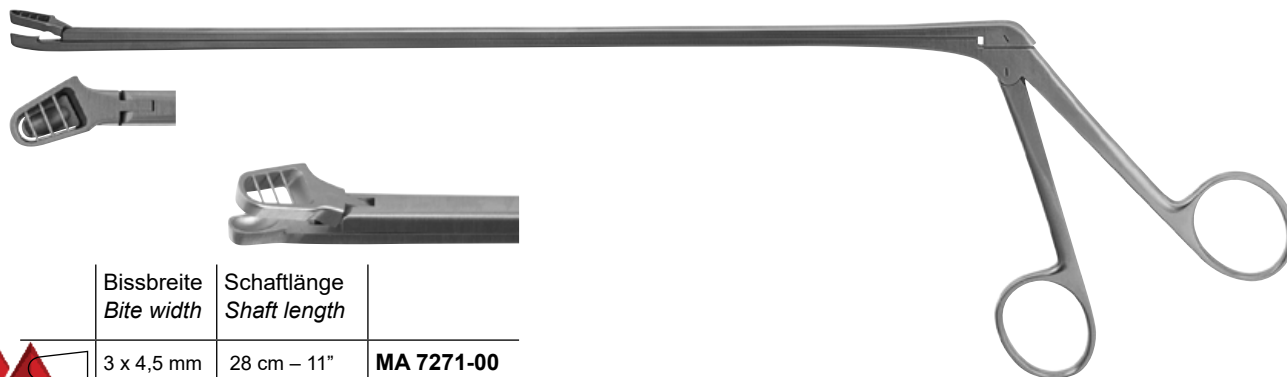

	Bissbreite Bite width	Schaftlänge Shaft length	
	3 x 4,5 mm	28 cm – 11"	MA 7271-00

ALEXANDER

Uterus-Biopsiezangen Uterine Biopsy Forceps

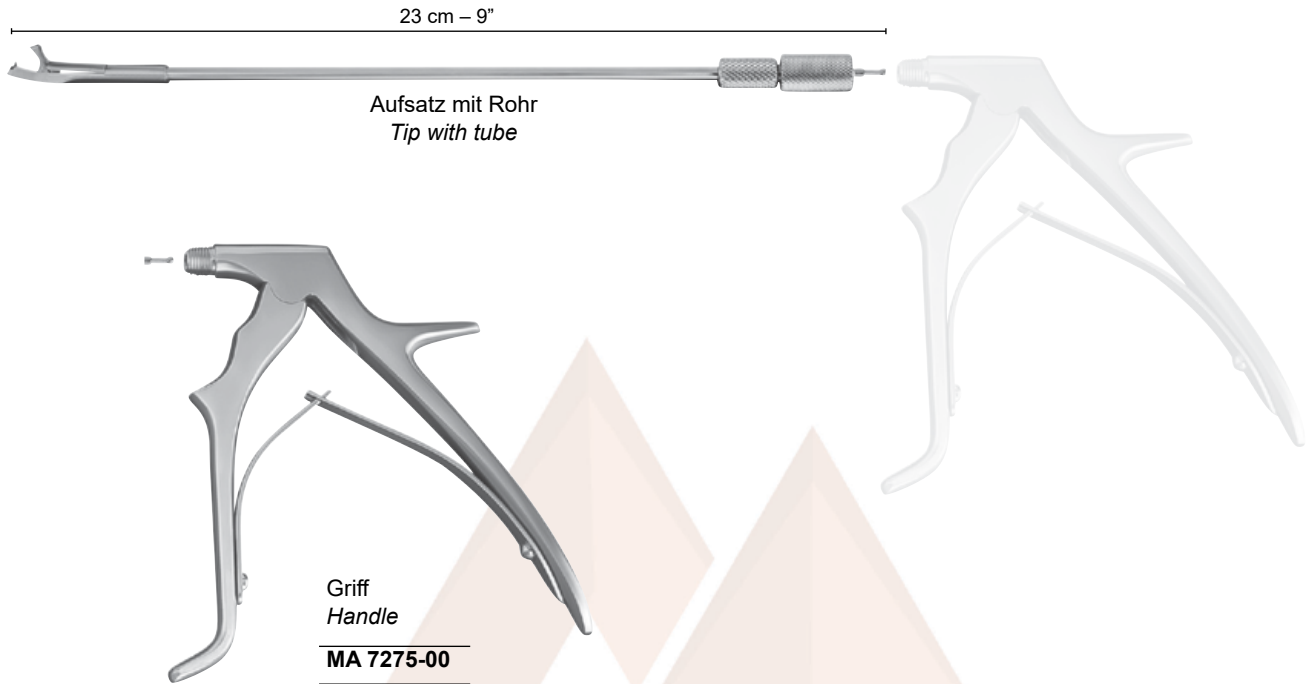

TISCHLER

Längelength	Bissbreite Bite width	Aufsatz, allein, gerade Tip, only, straight
23 cm - 9"	3 x 7 mm	MA 7275-10

Instrument
komplett
Instrument
complete

MA 7275-11



MINI-TOWNSEND-UP

Längelength	Bissbreite Bite width	Aufsatz, allein, auf- wärts gebogen, Tip, only, curved up
23 cm - 9"	2,3 x 5 mm	MA 7275-70

Instrument
komplett
Instrument
complete

MA 7275-71



MINI-TOWNSEND-DOWN

Längelength	Bissbreite Bite width	Aufsatz, al- lein, abwärts gebogen, Tip, only, curved down
23 cm - 9"	2,3 x 5 mm	MA 7275-80

Instrument
komplett
Instrument
complete

MA 7275-81

Uteruslöffel Uterine Scoops



Fig. 1	Fig. 2	Fig. 3	Fig. 4	Fig. 5	Fig. 6
MA 7280-01	MA 7280-02	MA 7280-03	MA 7280-04	MA 7280-05	MA 7280-06

30 cm – 11¾"

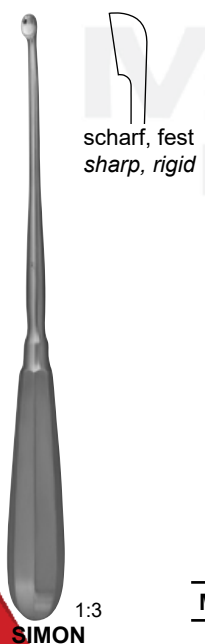
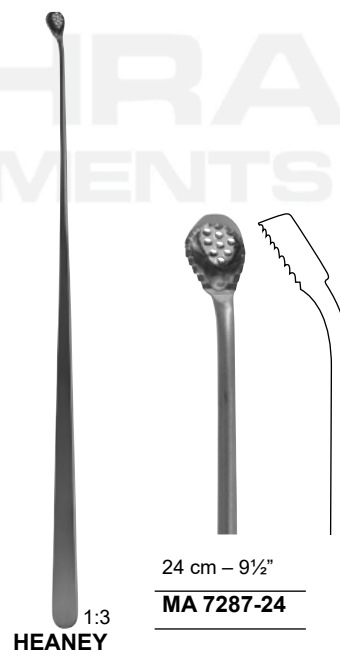
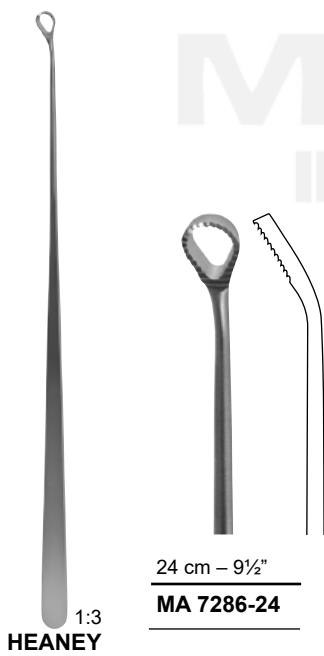
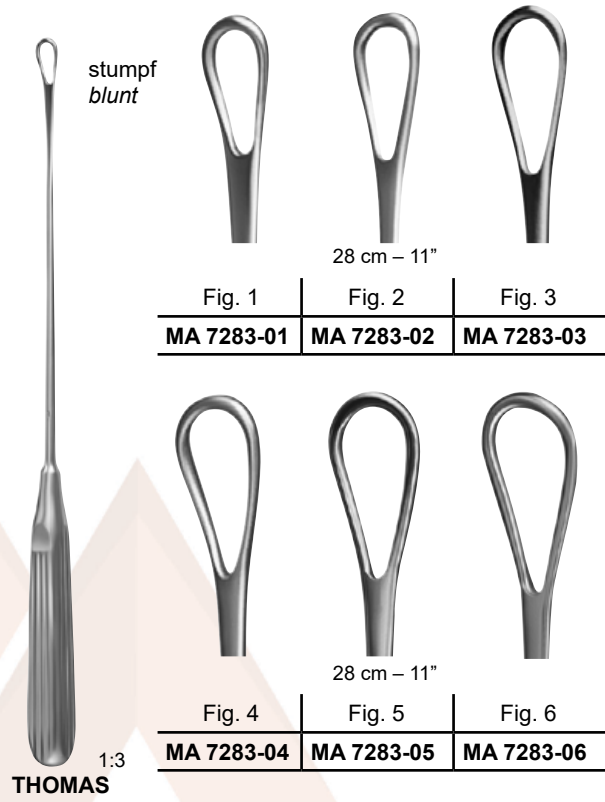
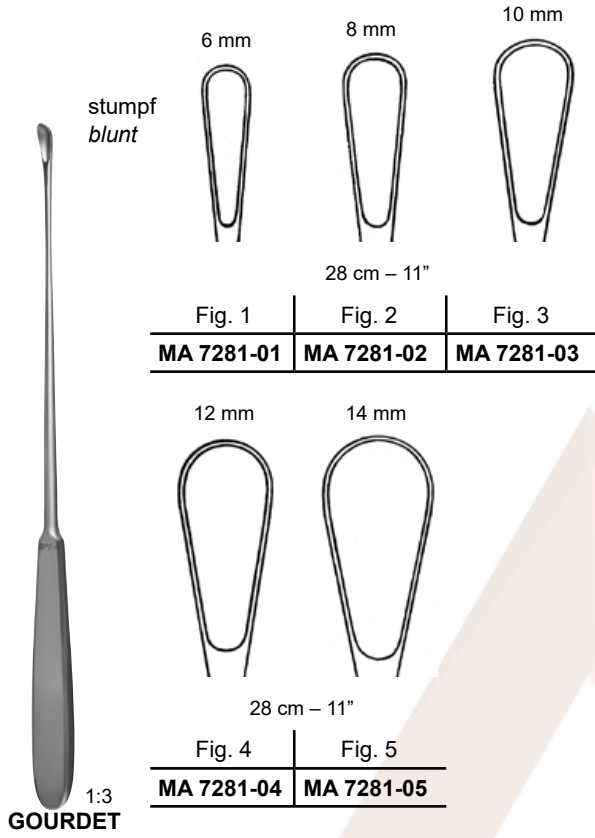

Fig. 1	Fig. 2	Fig. 3	Fig. 4
MA 7282-01	MA 7282-02	MA 7282-03	MA 7282-04

25 cm – 10"



Uterusküretten Uterine Curettes



M.ASHRAF
INSTRUMENTS



Uterusküretten Uterine Curettes

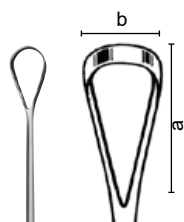

28 cm – 11"



	Fig. 1	Fig. 2	Fig. 3	Fig. 4	Fig. 5	Fig. 6
a x b	15 x 7,5 mm	17,5 x 8,5 mm	20 x 10,5 mm	22 x 12 mm	24 x 14 mm	28 x 15 mm
biegsam, scharf- malleable, sharp	MA 7300-01	MA 7300-02	MA 7300-03	MA 7300-04	MA 7300-05	MA 7300-06
biegsam, stumpf- malleable, blunt	MA 7302-01	MA 7302-02	MA 7302-03	MA 7302-04	MA 7302-05	MA 7302-06
fest, scharfrigid, sharp	MA 7304-01	MA 7304-02	MA 7304-03	MA 7304-04	MA 7304-05	MA 7304-06
fest, stumpfrigid, blunt	MA 7306-01	MA 7306-02	MA 7306-03	MA 7306-04	MA 7306-05	MA 7306-06

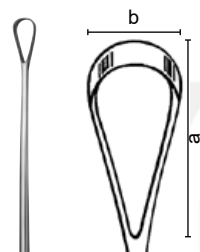

26 cm – 10 1/4"

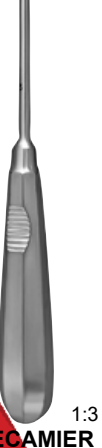
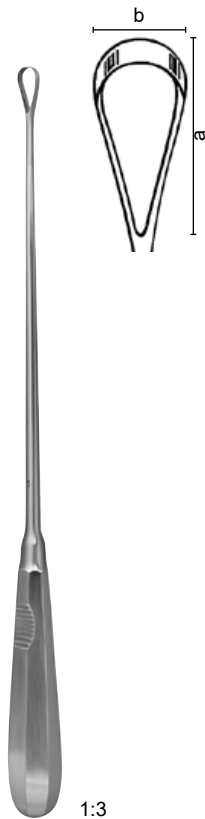

Fig.	a x b mm	biegsammallea- ble	festrigid	festrigid
		scharfsharp	scharfsharp	stumpfblunt
00	9 x 5	MA 7310-05	MA 7314-05	MA 7316-05
0	12 x 6	MA 7310-06	MA 7314-06	MA 7316-06
1	14 x 7	MA 7310-07	MA 7314-07	MA 7316-07
2	16 x 8	MA 7310-08	MA 7314-08	MA 7316-08
3	18 x 9	MA 7310-09	MA 7314-09	MA 7316-09
4	22 x 11	MA 7310-11	MA 7314-11	MA 7316-11
5	24 x 12	MA 7310-12	MA 7314-12	MA 7316-12
6	28 x 14	MA 7310-14	MA 7314-14	MA 7316-14
7	33 x 15	MA 7310-15	MA 7314-15	MA 7316-15
8	35 x 16	MA 7310-16	MA 7314-16	MA 7316-16

Uterusküretten Uterine Curettes



1:3
RECAMIER

Fig.	a x b mm	biegsammalleable	festrigid	festrigid
		scharfsharp	scharfsharp	stumpfblunt
31 cm – 12¼"				
00	9 x 5	MA 7318-05	MA 7322-05	MA 7324-05
0	12 x 6	MA 7318-06	MA 7322-06	MA 7324-06
1	14 x 7	MA 7318-07	MA 7322-07	MA 7324-07
2	16 x 8	MA 7318-08	MA 7322-08	MA 7324-08
3	18 x 9	MA 7318-09	MA 7322-09	MA 7324-09
4	22 x 11	MA 7318-11	MA 7322-11	MA 7324-11
5	24 x 12	MA 7318-12	MA 7322-12	MA 7324-12
6	28 x 14	MA 7318-14	MA 7322-14	MA 7324-14
7	33 x 15	MA 7318-15	MA 7322-15	MA 7324-15
8	35 x 16	MA 7318-16	MA 7322-16	MA 7324-16
9	38 x 19	MA 7318-19	MA 7322-19	MA 7324-19
10	40 x 20	MA 7318-20	MA 7322-20	MA 7324-20
11	45 x 21	MA 7318-21	MA 7322-21	MA 7324-21
12	48 x 23	MA 7318-23	MA 7322-23	MA 7324-23
34 cm – 13½"				
13	50 x 25	MA 7318-25	MA 7322-25	MA 7324-25
14	55 x 30	MA 7318-30	MA 7322-30	MA 7324-30
15	60 x 35	MA 7318-35	MA 7322-35	MA 7324-35
16	65 x 40	MA 7318-40	MA 7322-40	MA 7324-40

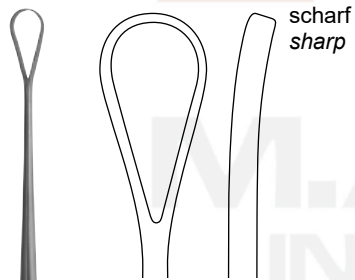

1:3
BLAKE

27 cm – 10½"

MA 7330-27

scharf
sharp

stumpf
blunt

Biopsie- und Absaugküretten Biopsy and Aspirating Curettes



graduiert
graduated

Ø mm	28 cm – 11"
4	MA 7289-04
6	MA 7289-06
8	MA 7289-08
10	MA 7289-10
12	MA 7289-12
14	MA 7289-14

1:3

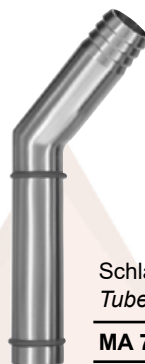

Schlauch-Verbindungsstück
Tube connecting piece

MA 7289-50



1:3

MILAN

M.ASHRAF
INSTRUMENTS



Ø 5 mm



28,5 cm – 11¼"

Ø 7 mm



Ø 9 mm

biegsam-
malleable

MA 7290-05

MA 7290-07

MA 7290-09



SCHULTZE

Salpingograph zur Hystereo-Salpingographie
komplett in Holzetui, bestehend aus:

Salpingograph for utero-salpingography
complete in wooden case, consisting of:

MA 7350-00

- 1 Manometer (MA 7350-01)
- 1 Manometer (MA 7350-01)
- 1 Zwischenstück, ohne Manometer (MA 7350-02)
- 1 Connection, without manometer (MA 7350-02)
- 1 Tubenkatheter mit Hahn, ohne Kugel (MA 7350-03)
- 1 Uterine cannula with tap, without cone (MA 7350-03)
- 1 Kegel, klein (MA 7350-04)
- 1 Cone, small (MA 7350-04)
- 1 Kegel, mittel (MA 7350-05)
- 1 Cone, medium (MA 7350-05)
- 1 Kegel, groß (MA 7350-06)
- 1 Cone, large (MA 7350-06)
- 1 Holzetui (MA 7350-20)
- 1 Wooden case (MA 7350-20)

Manometer
Manometer

MA 7350-01



Zwischenstück
Connection

MA 7350-02



Tubenkatheter
mit Hahn, ohne Kugel
Uterine cannula
with tap, without cone

MA 7350-03



klein
small

MA 7350-04



mittel
medium

MA 7350-05



groß
large

MA 7350-06

Salpingograph Salpingograph

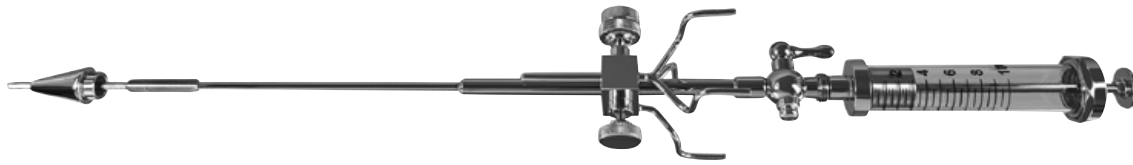

SCHULTZE

Salpingograph zur Hystereo-Salpingographie
komplett in Holzetui, bestehend aus:

MA 7360-00

Salpingograph for utero-salpingography
complete in wooden case, consisting of:

- 1 Zwischenstück, ohne Manometer (MA 7350-02)
- 1 Connection, without manometer (MA 7350-02)
- 1 Tubenkatheter mit Hahn, ohne Kugel (MA 7350-03)
- 1 Uterine cannula with tap, without cone (MA 7350-03)
- 1 Kegel, klein (MA 7350-04)
- 1 Cone, small (MA 7350-04)
- 1 Kegel, mittel (MA 7350-05)
- 1 Cone, medium (MA 7350-05)
- 1 Kegel, groß (MA 7350-06)
- 1 Cone, large (MA 7350-06)
- 1 Holzetui (MA 7350-20)
- 1 Wooden case (MA 7350-20)

Zwischenstück
Connection

MA 7350-02



Tubenkatheter
mit Hahn, ohne Kugel
Uterine cannula
with tap, without cone

MA 7350-03



klein
small

MA 7350-04



mittel
medium

MA 7350-05



groß
large

MA 7350-06



14 cm – 5½"
MA 3426-14

DE MARTEL (WILLET)



19 cm – 7½"
MA 7420-19

DE MARTEL (WILLET)

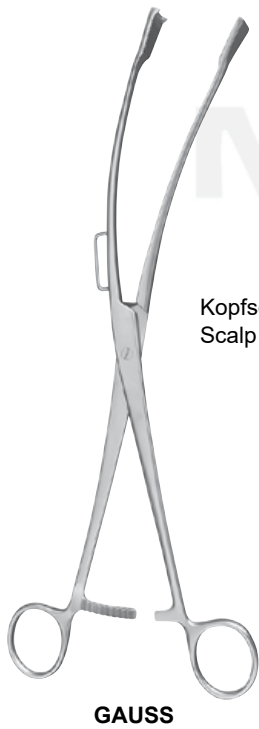

Kopfschwartzange
Scalp flap forceps

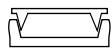
26 cm – 10¼"
MA 7419-26

GAUSS

1:3



Geburtslöffel Ele-
vating spoon

28 cm – 11"
MA 7425-28

SELLHEIM

1:3



Perforatorium
Perforator

25 cm – 10"

MA 7432-25

NÄGELE



Nabelschnurklemme
Umbilical cord clamp

9 cm – 3½"

MA 7436-29

COLLIN

M.ASHRAF
INSTRUMENTS

Geburtszangen Obstetrical Forceps



1:4
SIMPSON-LUIKART

36,5 cm – 14½"
MA 7447-36



1:3
SIMPSON

23 cm – 9"
MA 7445-23



1:4
SIMPSON

30 cm – 11¼"
MA 7445-30

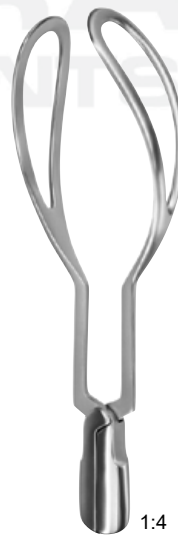

1:4
WRIGLEY

28 cm – 11"
MA 7442-28

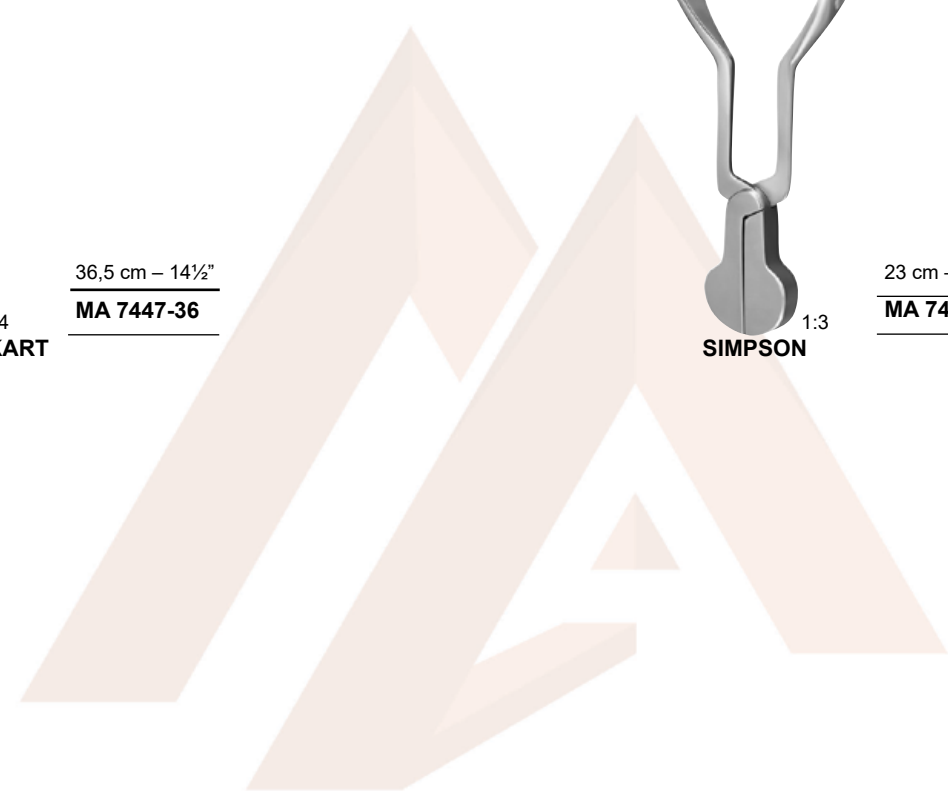

M.ASHRAF
INSTRUMENTS

Geburtszangen Obstetrical Forceps



MC LEAN

1:4

36 cm – 14¼"

MA 7463-36



SIMPSON-BRAUN

1:4

36 cm – 14¼"

MA 7446-36



NÄGELE

1:4

36 cm – 14¼" | MA 7440-36

40 cm – 15¾" | MA 7440-40



KIELLAND

1:4

41 cm – 16¼"

MA 7460-41

Geburtszangen Obstetrical Forceps

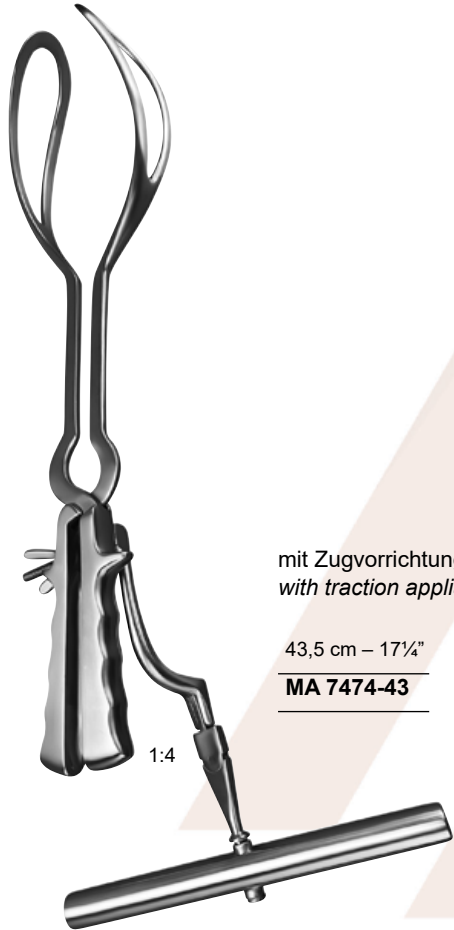

mit Zugvorrichtung
with traction appliance

43,5 cm – 17¼"

MA 7474-43

BARNES-NEVILLE

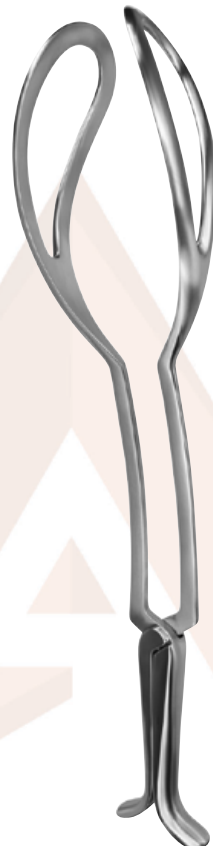

für nachkommenden
Kopf bei Steisslagen
*for delivery of the after
coming head in breech
presentation*

44 cm – 17¼"

MA 7472-44

PIPER

M.ASHRAF
INSTRUMENTS

Abortuszangen Ovum Forceps



WINTER



gerade
straight

28 cm – 11"

MA 7410-01	MA 7410-02	MA 7410-03
------------	------------	------------



WINTER



gebogen
curved

28 cm – 11"

MA 7411-01	MA 7411-02	MA 7411-03
------------	------------	------------

Abortus- und Plazentanzangen

Ovum and Placenta Forceps

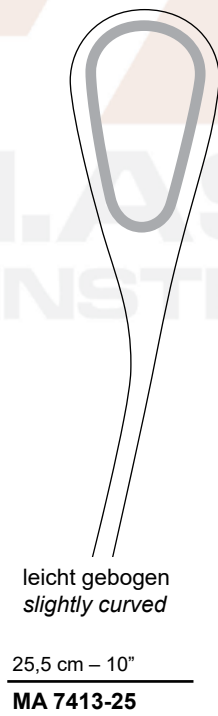
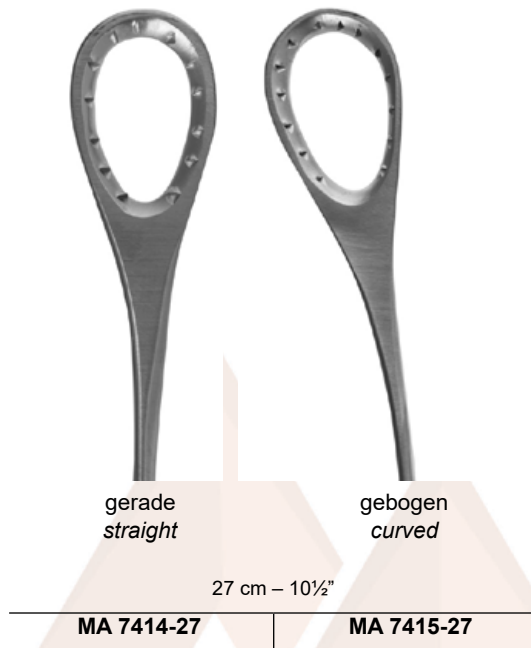
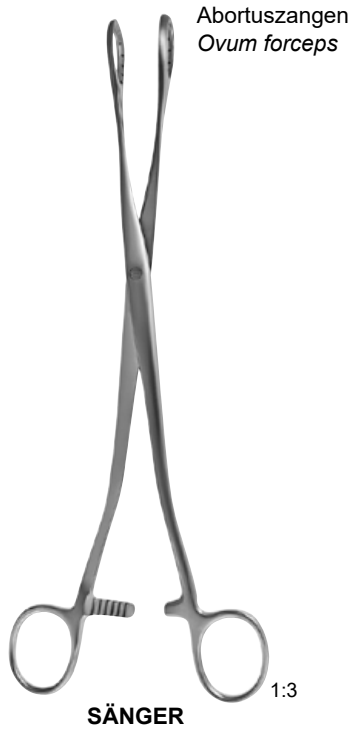

Uterusklemmzangen
Uterine Forceps

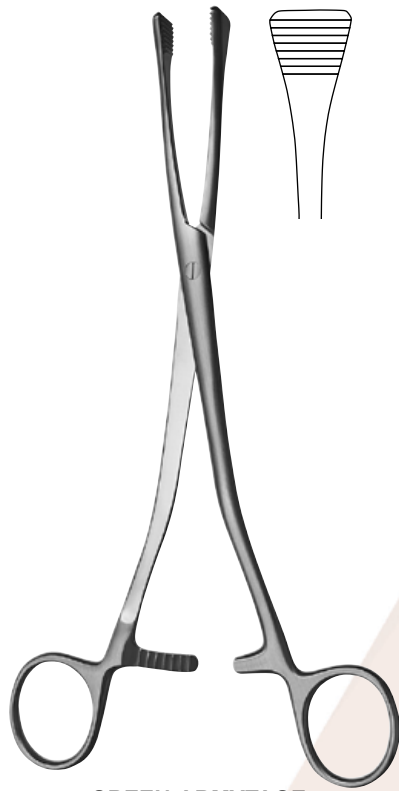

21 cm – 8¼"

MA 7418-21

GREEN-ARMYTAGE

M.ASHRAF
INSTRUMENTS

TEN



M.ASHRAF
INSTRUMENTS

Knochenchirurgie

Bone Surgery

Meißel und Osteotome	<i>Chisels and Osteotomes</i>	BS 1 - 8
Scharfe Löffel	<i>Bone Curettes</i>	BS 9 - 15
Knochenraspel	<i>Bone Rasps</i>	BS 16
Rasparatorien	<i>Raspatories</i>	BS 17 - 24
Rasparatorien und Elevatorien	<i>Raspatories and Elevators</i>	BS 25
Elevatorien	<i>Elevators</i>	BS 26 - 27
Knochenhebel	<i>Bone Levers</i>	BS 28 - 31
Knochenhaken	<i>Bone Retractors</i>	BS 32 - 34
Spinalhaken, Meniskusmesser	<i>Spinal Retractors, Meniscus Knives</i>	BS 35
Knochenhaltezangen	<i>Bone Holding Forceps</i>	BS 36 - 44
Hohlmeißelzangen	<i>Bone Rongeurs</i>	BS 45 - 56
Knochensplitterzangen	<i>Bone Cutting Forceps</i>	BS 57 - 59
Instrumente für Fingernägel	<i>Nail Instruments</i>	BS 60
Sägen und Sägeblätter	<i>Saws and Saw Blades</i>	BS 61 - 62
Bohrapparate	<i>Hand Drills</i>	BS 63 - 65
Reibahlen	<i>Reamers</i>	BS 66
Bohrdrähte, Steinmann-Nägel	<i>Drill Wires, Steinmann Pins</i>	BS 67 - 69
Drahtspannzangen	<i>Wire Twisting Forceps</i>	BS 70 - 71
Drahtfasszangen	<i>Wire Holding Forceps</i>	BS 72
Flachzangen	<i>Flat Nose Pliers</i>	BS 73
Drahtschneidezangen	<i>Wire Cutting Pliers</i>	BS 74 - 76
Extensionsbügel	<i>Extension Bows</i>	BS 77
Cerclage-Instrumente	<i>Cerclage Instruments</i>	BS 78
Hämmer	<i>Mallets</i>	BS 79 - 84
Sehneninstrumente, Bleihand	<i>Tendon Instruments, Lead hand</i>	BS 85 - 87

Meißel und Osteotome Chisels and Osteotomes



Griff
Handle

MA 5301-00



5 mm

MA 5301-05



10 mm

MA 5301-10



16 mm

MA 5301-16



25 mm

MA 5301-25

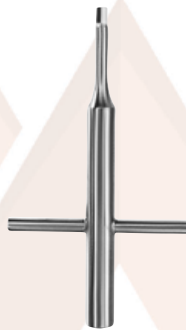

Schlüssel
Wrench

MA 5301-06

Satz Meißel komplett, bestehend aus:
Chisel set complete, consisting of:

MA 5301-50

- 1 Griff (MA 5301-00)
- 1 Handle (MA 5301-00)
- 1 Meißelklinge, 10 mm (MA 5301-10)
- 1 Chisel blade, 10 mm (MA 5301-10)
- 1 Meißelklinge, 16 mm (MA 5301-16)
- 1 Chisel blade, 16 mm (MA 5301-16)
- 1 Meißelklinge, 25 mm (MA 5301-25)
- 1 Chisel blade, 25 mm (MA 5301-25)
- 1 Schlüssel (MA 5301-06)
- 1 Wrench (MA 5301-06)

Meißelklinge, 5 mm (MA 5301-05) optional
Chisel blade, 5 mm (MA 5301-05) optional

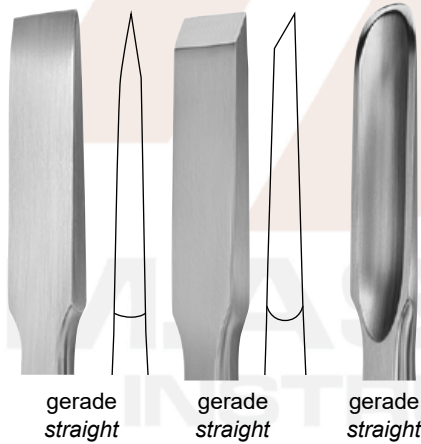

	Osteotome Osteotomes	Flachmeißel Chisels	Hohlmeißel Gouges
	13,5 cm – 5 1/4"		
4 mm	MA 5300-04	MA 5302-04	MA 5304-04
6 mm	MA 5300-06	MA 5302-06	MA 5304-06
8 mm	MA 5300-08	MA 5302-08	MA 5304-08
10 mm	MA 5300-10	MA 5302-10	MA 5304-10
12 mm	MA 5300-12	MA 5302-12	MA 5304-12
14 mm	MA 5300-14	MA 5302-14	MA 5304-14
16 mm	MA 5300-16	MA 5302-16	MA 5304-16



LUCAS

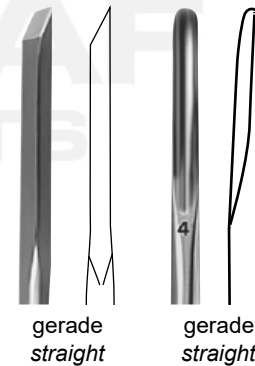

	Flachmeißel Chisels	Hohlmeißel Gouges
	16 cm – 6 1/4"	
4 mm	MA 5305-34	MA 5305-44
6 mm	MA 5305-36	MA 5305-46



Meißel und Osteotome Chisels and Osteotomes



MODELL USA
USA PATTERN

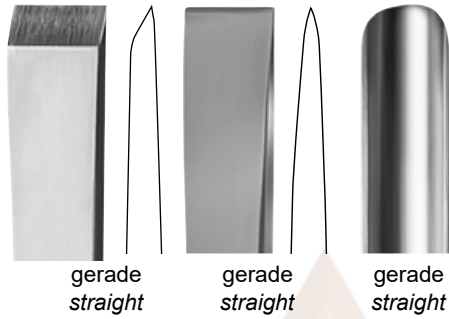

	Flachmeißel Chisels	Osteotome Osteotomes	Hohlmeißel Gouges
	16 cm – 6¼"		
6 mm	MA 5311-01	MA 5311-11	MA 5311-21
12 mm	MA 5311-02	MA 5311-12	MA 5311-22
18 mm	MA 5311-03	MA 5311-13	MA 5311-23



Stößel
Pestles

	3 mm	5 mm
	16 cm – 6¼"	
	MA 5317-03	MA 5317-05
	7 mm	9 mm
	16 cm – 6¼"	
	MA 5317-07	MA 5317-09

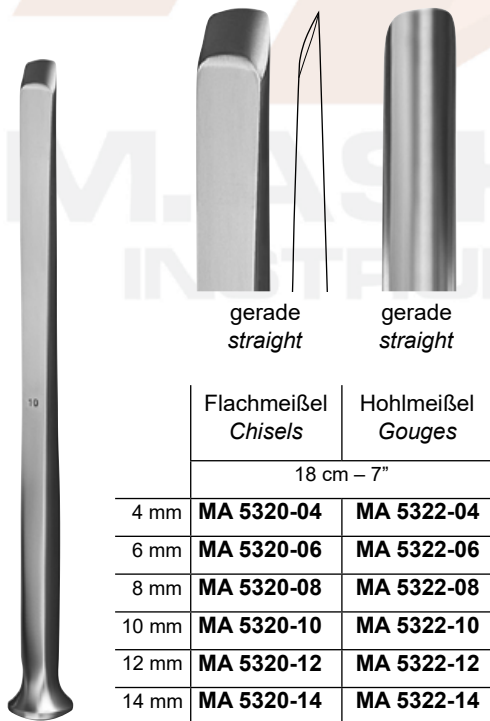

ALEXANDER

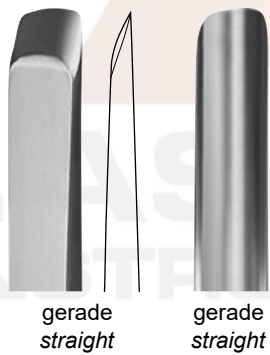

	Flachmeißel Chisels	Hohlmeißel Gouges
	18 cm – 7"	
4 mm	MA 5320-04	MA 5322-04
6 mm	MA 5320-06	MA 5322-06
8 mm	MA 5320-08	MA 5322-08
10 mm	MA 5320-10	MA 5322-10
12 mm	MA 5320-12	MA 5322-12
14 mm	MA 5320-14	MA 5322-14

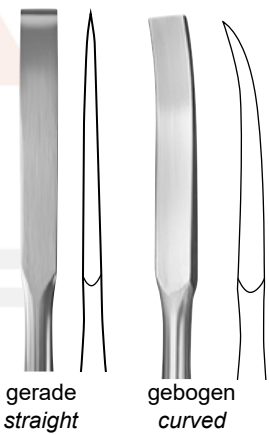

	Osteotome Osteotomes	Osteotome Osteotomes
	14 cm – 5½"	
2 mm	MA 5321-01	MA 5321-11
3 mm	MA 5321-02	MA 5321-12
4 mm	MA 5321-03	MA 5321-13
5 mm	MA 5321-04	MA 5321-14
6 mm	MA 5321-05	MA 5321-15
7 mm	MA 5321-06	MA 5321-16
8 mm	MA 5321-07	MA 5321-17



HOKÉ

Meißel und Osteotome Chisels and Osteotomes



Osteotome mit
Markierung
Osteotomes with
depth marking

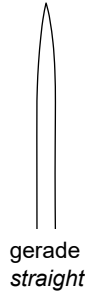

gerade
straight

	18 cm – 7"
2 mm	MA 8253-02
4 mm	MA 8253-04
6 mm	MA 8253-06
7 mm	MA 8253-07
9 mm	MA 8253-09
12 mm	MA 8253-12

COTTLE



Flachmeißel mit
Markierung
Chisels with
depth marking



gerade
straight

	18 cm – 7"
4 mm	MA 8258-04
6 mm	MA 8258-06
7 mm	MA 8258-07
9 mm	MA 8258-09
12 mm	MA 8258-12

COTTLE



SMITH-PETERSEN



gerade
straight



gebogen
curved



gerade
straight



gebogen
curved

	Osteotome Osteotomes		Hohlmeißel Gouges	
	20,5 cm – 8"			
6 mm	MA 5323-06	MA 5325-06	MA 5327-06	MA 5329-06
9 mm	MA 5323-09	MA 5325-09	MA 5327-09	MA 5329-09
13 mm	MA 5323-13	MA 5325-13	MA 5327-13	MA 5329-13
16 mm	MA 5323-16	MA 5325-16	MA 5327-16	MA 5329-16
19 mm	MA 5323-19	MA 5325-19	MA 5327-19	MA 5329-19
25 mm	MA 5323-25	MA 5325-25	MA 5327-25	MA 5329-25
32 mm	MA 5323-32	MA 5325-32	MA 5327-32	MA 5329-32

Meißel und Osteotome Chisels and Osteotomes



LAMBOTTE

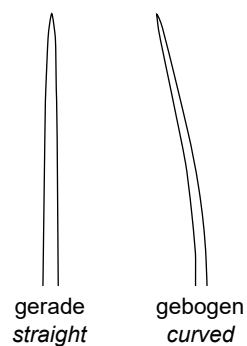

	Osteotome Osteotomes	
	24,5 cm – 9 ³ / ₄ "	
4 mm	MA 5330-04	MA 5331-04
6 mm	MA 5330-06	MA 5331-06
8 mm	MA 5330-08	MA 5331-08
10 mm	MA 5330-10	MA 5331-10
13 mm	MA 5330-13	MA 5331-13
16 mm	MA 5330-16	MA 5331-16
18 mm	MA 5330-18	MA 5331-18
20 mm	MA 5330-20	MA 5331-20
25 mm	MA 5330-25	MA 5331-25
30 mm	MA 5330-30	MA 5331-30
38 mm	MA 5330-38	MA 5331-38
44 mm	MA 5330-44	MA 5331-44
50 mm	MA 5330-50	MA 5331-50

M.ASHRAF
INSTRUMENTS



MINI-LAMBOTTE

	Osteotome Osteotomes	
	12,5 cm – 5" – 6 ³ / ₄ "	17 cm – 6 ³ / ₄ "
2 mm	MA 5332-02	MA 5333-02
3 mm	MA 5332-03	MA 5333-03
4 mm	MA 5332-04	MA 5333-04
6 mm	MA 5332-06	MA 5333-06
8 mm	MA 5332-08	MA 5333-08
10 mm	MA 5332-10	MA 5333-10
12 mm	MA 5332-12	MA 5333-12
15 mm	MA 5332-15	MA 5333-15



Meißel und Osteotome Chisels and Osteotomes

Instrumente mit **Propylux** Griffen

Ein hochstabiles Thermoplast mit wesentlich besseren Eigenschaften als das oft verwendete Ferrozell:

Exzellente Resistenz gegen Säuren und Laugen, daher hygienisch unbedenklicher als Ferrozell Hohe Formstabilität auch nach Hunderten von

Steri-Zyklen

Hohe Festigkeit auch bei extremer Beanspruchung

Hohe Farbbeständigkeit

Enorme Reduzierung von Reparaturen

Zugelassen bei der FDA

Geeignet für alle Sterilisationsverfahren

Instruments with **Propylux** Handles

A highly resistant thermoplastic having much better characteristics than the often used Ferrozell:

Excellent resistance against acids and leaches, therefore much safer than Ferrozell from the hygiene point of view

High form stability even after hundreds of sterilisation cycles

High solidity even when exposed to extreme loads

Highly colour-fast

Tremendously reduced need of repair

FDA approved

Suitable for all sterilisation procedures



LEXER

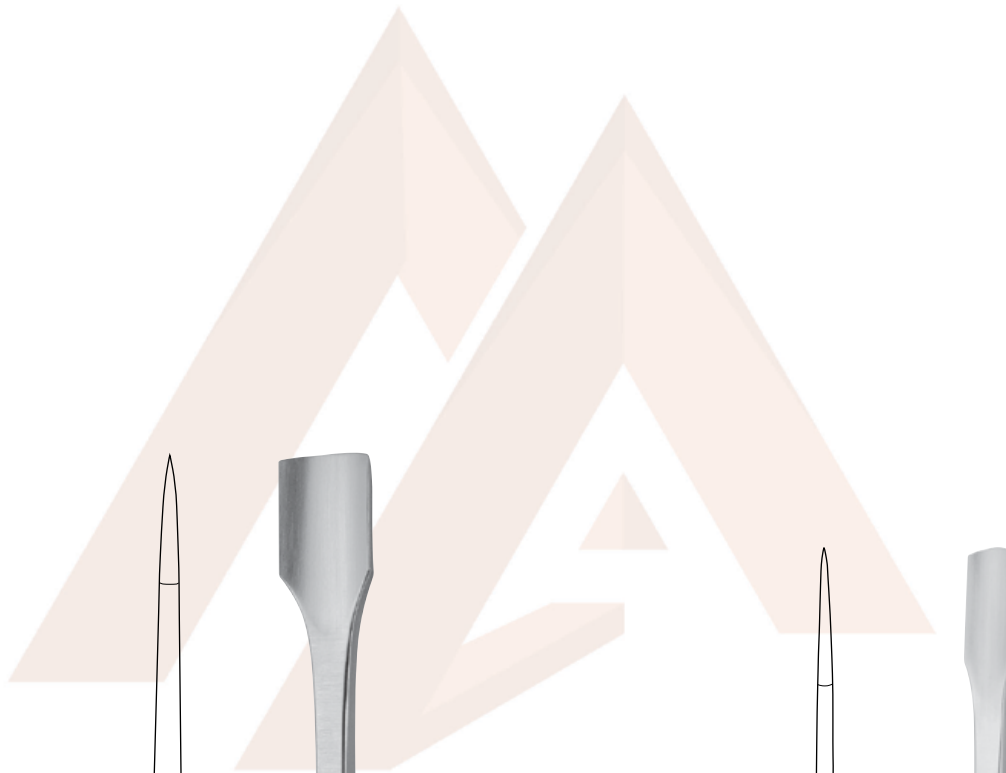

LEXER

gerade
straight

gerade
straight

	Osteotome Osteotomes	Hohlmeißel Gouges
--	-------------------------	----------------------

22 cm – 8¾"

5 mm	MA 5336-05X	MA 5338-05X
7 mm	MA 5336-07X	MA 5338-07X
10 mm	MA 5336-10X	MA 5338-10X
15 mm	MA 5336-15X	MA 5338-15X
20 mm	MA 5336-20X	MA 5338-20X
25 mm	MA 5336-25X	MA 5338-25X
30 mm	MA 5336-30X	MA 5338-30X
40 mm	MA 5336-40X	MA 5338-40X

MINI-LEXER

gerade
straight

gerade
straight

	Osteotome Osteotomes	Hohlmeißel Gouges
--	-------------------------	----------------------

18 cm – 7"

4 mm	MA 5334-04X	MA 5335-04X
6 mm	MA 5334-06X	MA 5335-06X
8 mm	MA 5334-08X	MA 5335-08X
10 mm	MA 5334-10X	MA 5335-10X
12 mm	MA 5334-12X	MA 5335-12X

Meißel und Osteotome

Chisels and Osteotomes



STILLE



gerade
straight



gerade
straight



gebogen
curved



gerade
straight



gebogen
curved

	Flachmeißel Chisels	Osteotome Osteotomes		Hohlmeißel Gouges	
	20 cm – 8"				
6 mm	MA 5340-06	MA 5341-06	MA 5341-56	MA 5342-06	MA 5342-56
8 mm	MA 5340-08	MA 5341-08	MA 5341-58	MA 5342-08	MA 5342-58
10 mm	MA 5340-10	MA 5341-10	MA 5341-60	MA 5342-10	MA 5342-60
12 mm	MA 5340-12	MA 5341-12	MA 5341-62	MA 5342-12	MA 5342-62
15 mm	MA 5340-15	MA 5341-15	MA 5341-65	MA 5342-15	MA 5342-65
20 mm	MA 5340-20	MA 5341-20	MA 5341-70	MA 5342-20	MA 5342-70
25 mm	MA 5340-25	MA 5341-25	MA 5341-75	MA 5342-25	MA 5342-75
30 mm	MA 5340-30	MA 5341-30	MA 5341-80	MA 5342-30	MA 5342-80



HIBBS 1:3



gerade
straight



gebogen
curved



gerade
straight



gebogen
curved



gerade
straight



gebogen
curved

	Osteotome Osteotomes		Flachmeißel Chisels		Hohlmeißel Gouges	
	24 cm – 9½"		24 cm – 9½"		24 cm – 9½"	
6 mm	MA 5344-06	MA 5344-56	MA 5345-06	MA 5345-56	MA 5346-06	MA 5346-56
9 mm	MA 5344-09	MA 5344-59	MA 5345-09	MA 5345-59	MA 5346-09	MA 5346-59
13 mm	MA 5344-13	MA 5344-63	MA 5345-13	MA 5345-63	MA 5346-13	MA 5346-63
16 mm	MA 5344-16	MA 5344-66	MA 5345-16	MA 5345-66	MA 5346-16	MA 5346-66
19 mm	MA 5344-19	MA 5344-69	MA 5345-19	MA 5345-69	MA 5346-19	MA 5346-69
22 mm	MA 5344-22	MA 5344-72	MA 5345-22	MA 5345-72	MA 5346-22	MA 5346-72
25 mm	MA 5344-25	MA 5344-75	MA 5345-25	MA 5345-75	MA 5346-25	MA 5346-75
28 mm	MA 5344-28	MA 5344-78	MA 5345-28	MA 5345-78	MA 5346-28	MA 5346-78
32 mm	MA 5344-32	MA 5344-82	MA 5345-32	MA 5345-82	MA 5346-32	MA 5346-82
38 mm	MA 5344-38	MA 5344-88	MA 5345-38	MA 5345-88	MA 5346-38	MA 5346-88

Meißel und Osteotome Chisels and Osteotomes

Instrumente mit **Propylux** Griffen

Ein hochstabiles Thermoplast mit wesentlich besseren Eigenschaften als das oft verwendete Ferrozell:

Exzellente Resistenz gegen Säuren und Laugen, daher hygienisch unbedenklicher als Ferrozell Hohe Formstabilität auch nach Hunderten von

Steri-Zyklen

Hohe Festigkeit auch bei extremer Beanspruchung

Hohe Farbbeständigkeit

Enorme Reduzierung von Reparaturen

Zugelassen bei der FDA

Geeignet für alle Sterilisationsverfahren

Instruments with **Propylux** Handles

A highly resistant thermoplastic having much better characteristics than the often used Ferrozell:

Excellent resistance against acids and leaches, therefore much safer than Ferrozell from the hygiene point of view

High form stability even after hundreds of sterilisation cycles

High solidity even when exposed to extreme loads

Highly colour-fast

Tremendously reduced need of repair

FDA approved

Suitable for all sterilisation procedures



Meißel und Osteotome Chisels and Osteotomes



Hohlmeißel
Gouges

27,5 cm – 10 3/4"

MA 5349-01	MA 5349-02	MA 5349-03	MA 5349-04
------------	------------	------------	------------

M.ASHRAF INSTRUMENTS

Scharfe Löffel Bone Curettes



Fig. 0000 – 2,5 mm

○ **MA 5350-40**

Fig. 000 – 3,6 mm

○ **MA 5350-30**

Fig. 00 – 4,4 mm

○ **MA 5350-20**

Fig. 0 – 5,2 mm

○ **MA 5350-10**

Fig. 1 – 6,8 mm

○ **MA 5350-01**

Fig. 2 – 8,5 mm

○ **MA 5350-02**

Fig. 3 – 10 mm

○ **MA 5350-03**

Fig. 4 – 11,5 mm

○ **MA 5350-04**

Fig. 5 – 13 mm

○ **MA 5350-05**

Fig. 6 – 14,5 mm

○ **MA 5350-06**



Fig. 000 – 3,3 mm

○ **MA 5351-08** | **MA 5351-58** | **MA 5351-78**

Fig. 00 – 3,9 mm

○ **MA 5351-09** | **MA 5351-59** | **MA 5351-79**

Fig. 0 – 4,7 mm

○ **MA 5351-10** | **MA 5351-60** | **MA 5351-80**

Fig. 1 – 5,3 mm

○ **MA 5351-11** | **MA 5351-61** | **MA 5351-81**

Fig. 2 – 6 mm

○ **MA 5351-12** | **MA 5351-62** | **MA 5351-82**

Fig. 3 – 7,2 mm

○ **MA 5351-13** | **MA 5351-63** | **MA 5351-83**

Fig. 4 – 8,2 mm

○ **MA 5351-14** | **MA 5351-64** | **MA 5351-84**

Fig. 5 – 9,8 mm

○ **MA 5351-15** | **MA 5351-65** | **MA 5351-85**

Fig. 6 – 12 mm

○ **MA 5351-16** | **MA 5351-66** | **MA 5351-86**



VOLKMANN

17 cm – 6¾"



BRUNS

23 cm – 9"

Scharfe Löffel Bone Curettes



Fig. 000 – 3,3 mm
○ **MA 5352-30**

○ Fig. 00 – 4,8 mm
MA 5352-20

○ Fig. 0 – 5,8 mm
MA 5352-10

○ Fig. 1 – 7,3 mm
MA 5352-01

○ Fig. 2 – 8,3 mm
MA 5352-02

○ Fig. 3 – 10,2 mm
MA 5352-03

○ Fig. 4 – 11,8 mm
MA 5352-04

○ Fig. 5 – 12,8 mm
MA 5352-05

○ Fig. 6 – 14 mm
MA 5352-06



BRUNS
17 cm – 6¾"



Fig. 0000 – 2,5 mm
○ **MA 5353-40**

○ Fig. 000 – 2,8 mm
MA 5353-30

○ Fig. 00 – 3,3 mm
MA 5353-20

○ Fig. 0 – 3,7 mm
MA 5353-10

○ Fig. 1 – 4,3 mm
MA 5353-01

○ Fig. 2 – 4,8 mm
MA 5353-02

○ Fig. 3 – 5,6 mm
MA 5353-03

○ Fig. 4 – 6,1 mm
MA 5353-04

○ Fig. 5 – 6,7 mm
MA 5353-05

○ Fig. 6 – 8,8 mm
MA 5353-06



SPRATT
17 cm – 6¾"

Scharfe Löffel Bone Curettes



schwedisches
Modell
swedish
pattern

2 mm
17 cm – 6¾"
MA 5354-22



3 mm
17 cm – 6¾"
MA 5354-23



4 mm
17 cm – 6¾"
MA 5354-24



5 mm
19,5 cm – 7¾"
MA 5354-25



6 mm
19,5 cm – 7¾"
MA 5354-26



7 mm
19,5 cm – 7¾"
MA 5354-27



8 mm
20 cm – 8"
MA 5354-28



10 mm
20,5 cm – 8"
MA 5354-30



12 mm
20,5 cm – 8"
MA 5354-32



14 mm
20,5 cm – 8"
MA 5354-34



2 mm
17 cm – 6¾"
MA 5354-42



3 mm
17 cm – 6¾"
MA 5354-43



4 mm
17 cm – 6¾"
MA 5354-44



5 mm
19,5 cm – 7¾"
MA 5354-45



6 mm
19,5 cm – 7¾"
MA 5354-46



7 mm
19,5 cm – 7¾"
MA 5354-47



8 mm
20 cm – 8"
MA 5354-48



10 mm
21 cm – 8¼"
MA 5354-50



12 mm
21,5 cm – 8½"
MA 5354-52



14 mm
22 cm – 8¾"
MA 5354-54



SCHEDE
17 cm – 6¾"

Fig. 000 – 3 mm
MA 5355-30



Fig. 00 – 4 mm
MA 5355-20



Fig. 0 – 5 mm
MA 5355-10



Fig. 1 – 6 mm
MA 5355-01



Fig. 2 – 7 mm
MA 5355-02



Fig. 3 – 8 mm
MA 5355-03



Fig. 4 – 9 mm
MA 5355-04



MASHRAF
INSTRUMENTS

Scharfe Löffel Bone Curettes



WILLIGER
17,5 cm – 7"

○ Fig. 00 – 2,5 mm
MA 5356-20

○ Fig. 0 – 3,2 mm
MA 5356-10

○ Fig. 1 – 4 mm
MA 5356-01

○ Fig. 2 – 5,7 mm
MA 5356-02



UFFENRODE

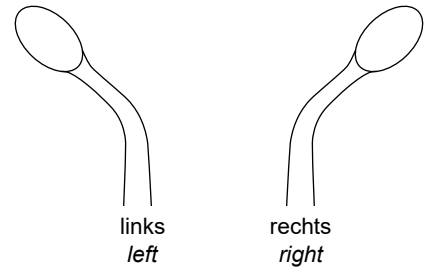

17 cm – 6¾"
MA 5357-01 | **MA 5357-02**



1:3
VOLKMANN
28 cm – 11"

○ Fig. 0 – 4,4 mm
MA 5358-10

○ Fig. 1 – 6,8 mm
MA 5358-01

○ Fig. 2 – 8,5 mm
MA 5358-02

○ Fig. 3 – 10 mm
MA 5358-03



DAUBENSPECK
20 cm – 8"

○ Fig. 00 – 2,8 mm
MA 5361-20

○ Fig. 0 – 3,6 mm
MA 5361-10

○ Fig. 1 – 4,4 mm
MA 5361-01

○ Fig. 2 – 5,2 mm
MA 5361-02





19 cm – 7½"



gerade, keramikbeschichtet
straight, ceramic coated

19 cm – 7½"

Fig. 000

MA 5363-101



19 cm – 7½"

Fig. 0

MA 5363-103



gebogen, keramikbeschichtet
curved, ceramic coated

19 cm – 7½"

Fig. 000

MA 5363-111



19 cm – 7½"

Fig. 0

MA 5363-113



rückwärts gebogen, keramikbeschichtet
reverse curved, ceramic coated

19 cm – 7½"

Fig. 000

MA 5363-301



19 cm – 7½"

Fig. 0

MA 5363-303

M.ASHRAF
INSTRUMENTS

Scharfe Löffel Bone Curettes

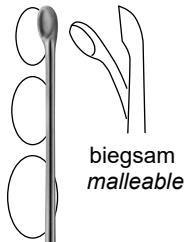

HALLE

21 cm – 8¼"



Fig. 1 – 4,8 mm

MA 5362-01

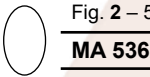

Fig. 2 – 5,8 mm

MA 5362-02

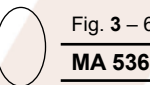

Fig. 3 – 6,8 mm

MA 5362-03



Fig. 000 – 3,6 mm

25 cm – 10"

○	MA 5363-01	MA 5363-11
---	-------------------	-------------------

Fig. 00 – 4,4 mm

25 cm – 10"

○	MA 5363-02	MA 5363-12
---	-------------------	-------------------

Fig. 0 – 5,2 mm

25 cm – 10"

○	MA 5363-03	MA 5363-13
---	-------------------	-------------------

Fig. 1 – 6 mm

25 cm – 10"

○	MA 5363-04	MA 5363-14
---	-------------------	-------------------



13 cm – 5"

MA 5364-13

14,5 cm – 5¾"

MA 5364-14



VOLKMANN

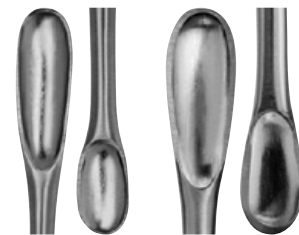

17 cm – 6¾"

MA 5364-17

20 cm – 8"

MA 5364-20



VOLKMANN



13 cm – 5"

MA 5365-13

16 cm – 6¼"

MA 5365-16

20 cm – 8"

MA 5365-20

Scharfe Löffel Bone Curettes



Ø 3,1 / 2,6 mm

MA 5366-00



Ø 3 / 2,5 mm

MA 5368-00



Ø 4,2 / 3,1 mm

MA 5366-01



Ø 3,5 / 3 mm

MA 5368-01



Ø 4,8 / 4,2 mm

MA 5366-12



Ø 4,2 / 3,5 mm

MA 5368-12



Ø 4 / 3,5 mm

MA 5369-13



MARTINI

13,5 cm – 5¼"



WILLIGER

13,5 cm – 5¼"



JACOBSON

13 cm – 5"

M.ASHRAF
INSTRUMENTS



JANSEN

15 cm – 6"



Ø 4,5 / 3,5 mm

MA 7921-15



Ø 6,5 / 6,2 mm

MA 5370-21



WILLIGER

20,5 cm – 8"

Knochenraspeln Bone Rasps

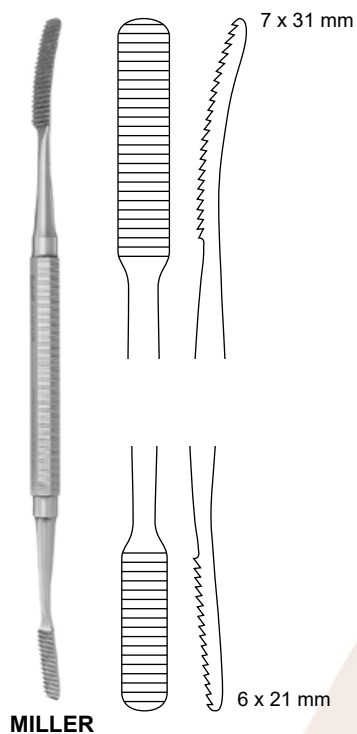

18 cm – 7"
MA 5374-02

MILLER



30 cm – 11¼"
MA 5375-30

PUTTI



27 cm – 10½"
MA 5376-27

PUTTI

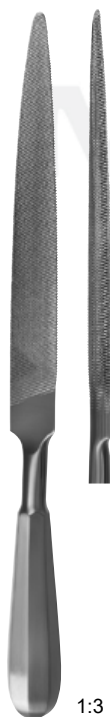

25 cm – 10"
MA 5377-25

1:3



24 cm – 9½"
MA 5378-24

1:3



22 cm – 8¾"
MA 5379-22

1:3





MOLT

scharf
sharp
19 cm – 7½"
MA 5379-19



FARABEUF



gerade
straight



gebogen
curved

15 cm – 6"
MA 5380-15 | **MA 5381-15**



SEDILLOT



18 mm
scharf
sharp
18,5 cm – 7¼"
MA 5382-18



SEDILLOT



15 mm
scharf
sharp
21,5 cm – 8½"
MA 5382-21

Raspatorien Raspatories



16 mm
scharf,
leicht gebogen
*sharp,
slightly curved*

19 cm – 7½"

MA 5384-18



15 mm

rund, scharf,
leicht gebogen
*round, sharp,
slightly curved*

MA 5384-30

eckig, scharf,
leicht gebogen
*square, sharp,
slightly curved*

18 cm – 7"

MA 5384-31



scharf,
leicht gebogen
*sharp,
slightly curved*

21,5 cm – 8½"

5 mm	MA 5385-05
10 mm	MA 5385-10
15 mm	MA 5385-15
20 mm	MA 5385-20
25 mm	MA 5385-25



13 mm

scharf, gebogen
sharp, curved

19 cm – 7½"

MA 5386-19



20 cm – 8"
MA 5387-20

ALEXANDER



JANSSEN



16,5 cm – 6½"
MA 5388-16

scharf,
leicht gebogen
*sharp,
slightly curved*



20 cm – 8"
MA 5389-19

SELDIN

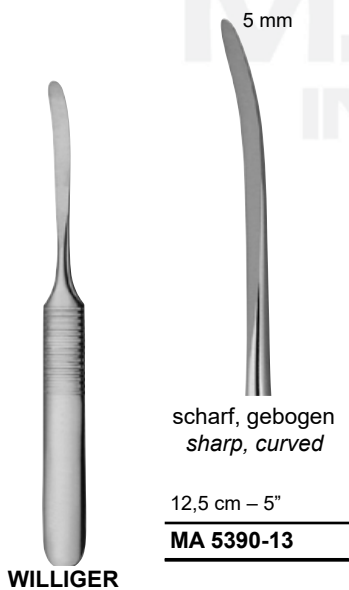

5 mm
scharf, gebogen
sharp, curved

12,5 cm – 5"
MA 5390-13

WILLIGER



5 mm
scharf, gebogen
sharp, curved

15,5 cm – 6"
MA 5391-15

KÖNIG

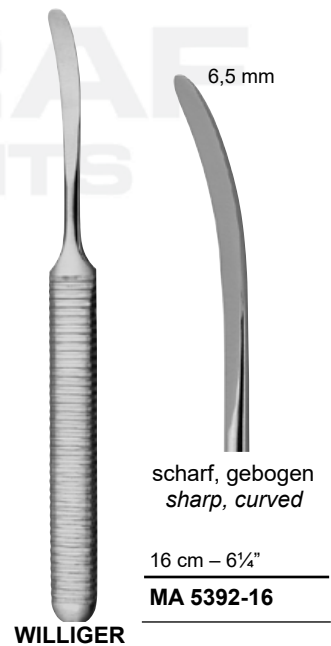

6,5 mm
scharf, gebogen
sharp, curved

16 cm – 6¼"
MA 5392-16

WILLIGER

M.ASHRAF
INSTRUMENTS

Raspatorien Raspatories

4,5 mm

scharf,
leicht gebogen
*sharp,
slightly curved*

16,5 cm – 6½"

MA 8206-16

JOSEPH

8 mm

scharf,
leicht gebogen
*sharp,
slightly curved*

19,5 cm – 7¾"

MA 8210-19

COTTLE

8 mm

scharf
sharp

7 mm

scharf
sharp

17 cm – 6¾"

MA 5393-01 | **MA 5393-03**

7 mm

7 mm

stumpf
blunt

scharf
sharp

17 cm – 6¾"

MA 5393-02 | **MA 5393-04**

ADSON

scharf, gebogen
sharp, curved

17 cm – 6¾"

6 mm	MA 5394-06
8 mm	MA 5394-08



SEMBO

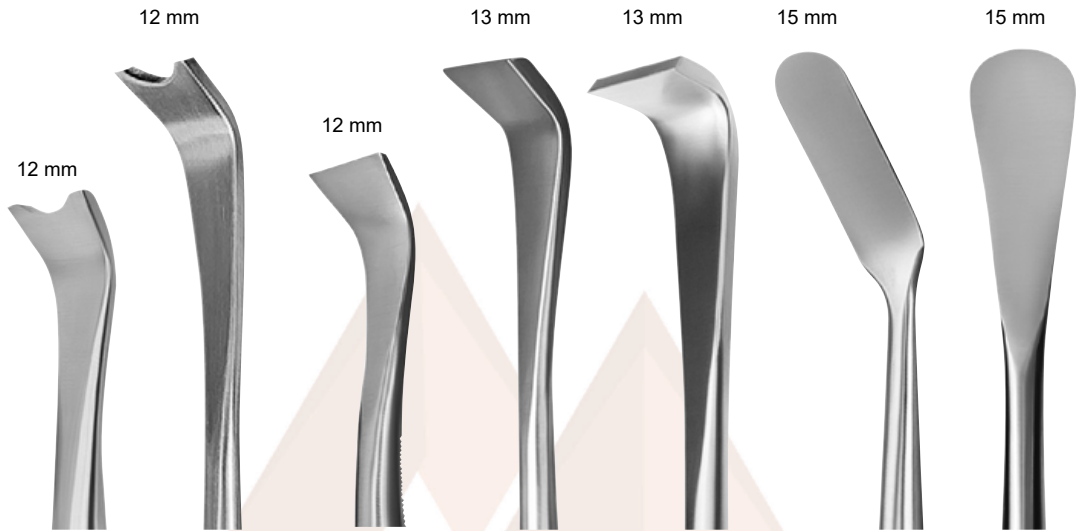

19,5 cm – 7¾"	21 cm – 8¼"	18 cm – 7"	20 cm – 8"	21,5 cm – 8½"	22 cm – 8¾"	22 cm – 8¾"
MA 5398-01	MA 5398-02	MA 5398-03	MA 5398-04	MA 5398-05	MA 5398-06	MA 5398-07



DOYEN

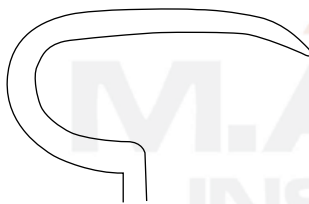

17 cm – 6¾"

MA 5400-01

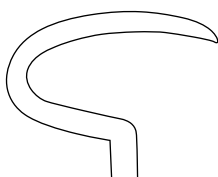

17 cm – 6¾"

MA 5402-01



DOYEN

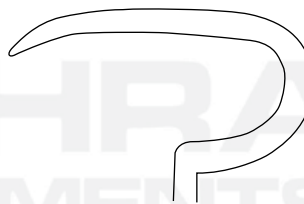

17 cm – 6¾"

MA 5400-02

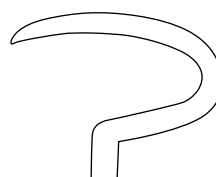

17 cm – 6¾"

MA 5402-02



SYME

7 mm

18 cm – 7"

MA 5407-01

Raspatorien Raspatories

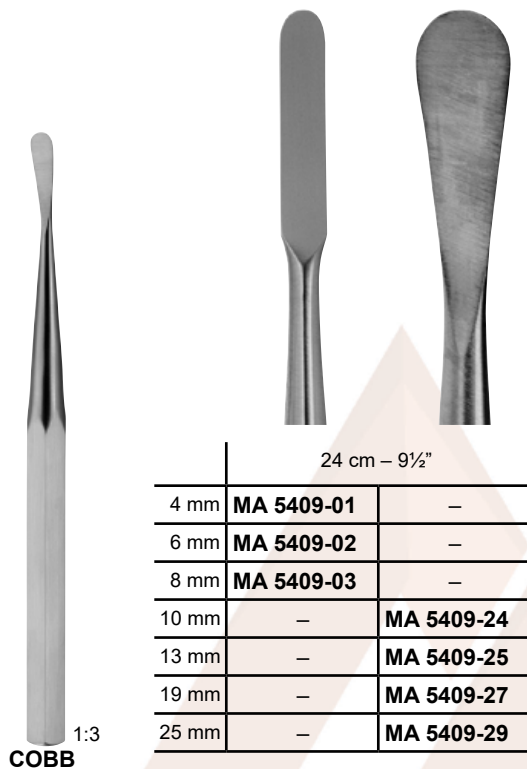

24 cm – 9½"		
4 mm	MA 5409-01	–
6 mm	MA 5409-02	–
8 mm	MA 5409-03	–
10 mm	–	MA 5409-24
13 mm	–	MA 5409-25
19 mm	–	MA 5409-27
25 mm	–	MA 5409-29

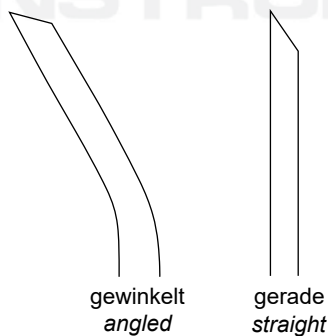
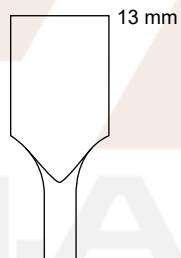

19 cm – 7½"	
MA 5410-05	MA 5410-15

Instrumente mit **Propylux** Griffen

Ein hochstabiles Thermoplast mit wesentlich besseren Eigenschaften als das oft verwendete Ferrozell:

Exzellente Resistenz gegen Säuren und Laugen, daher hygienisch unbedenklicher als Ferrozell Hohe Formstabilität auch nach Hunderten von

Steri-Zyklen

Hohe Festigkeit auch bei extremer Beanspruchung

Hohe Farbbeständigkeit

Enorme Reduzierung von Reparaturen

Zugelassen bei der FDA

Geeignet für alle Sterilisationsverfahren

Instruments with **Propylux** Handles

A highly resistant thermoplastic having much better characteristics than the often used Ferrozell:

Excellent resistance against acids and leaches, therefore much safer than Ferrozell from the hygiene point of view

High form stability even after hundreds of sterilisation cycles

High solidity even when exposed to extreme loads

Highly colour-fast

Tremendously reduced need of repair

FDA approved

Suitable for all sterilisation procedures

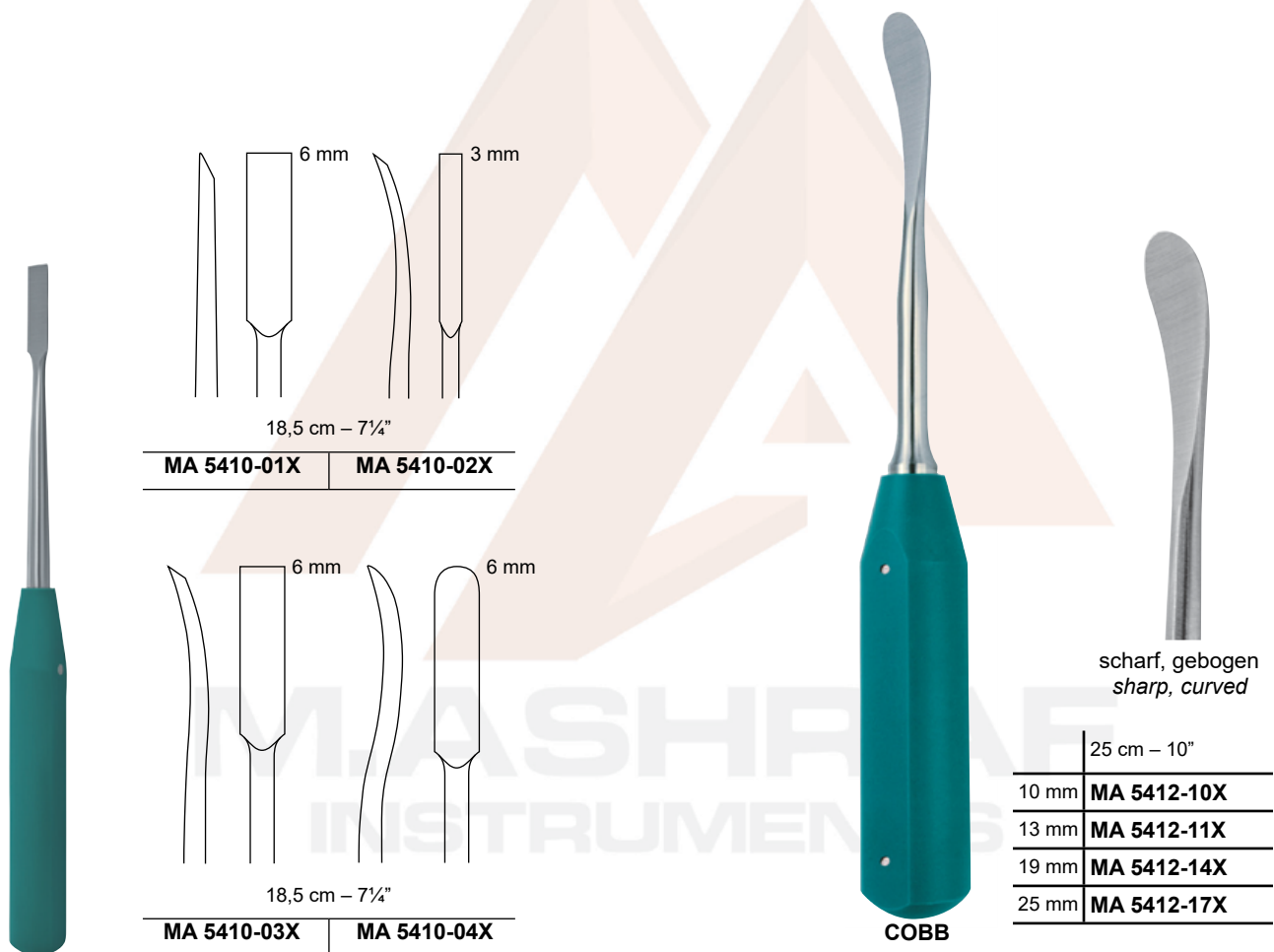

Raspatorien Raspatories

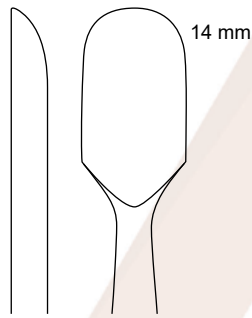

20,5 cm – 8"

MA 5410-06

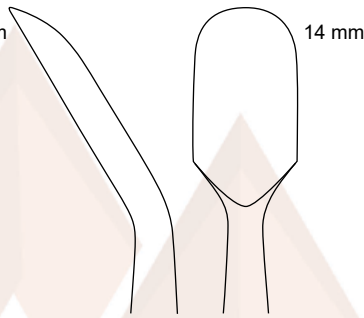

20 cm – 8"

MA 5410-07

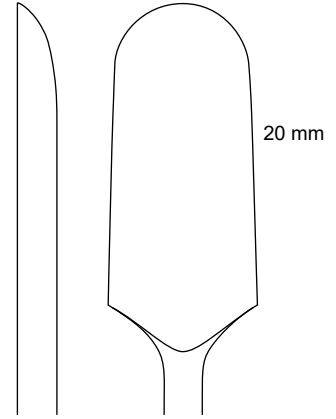

20 cm – 8"

MA 5410-20



1:4

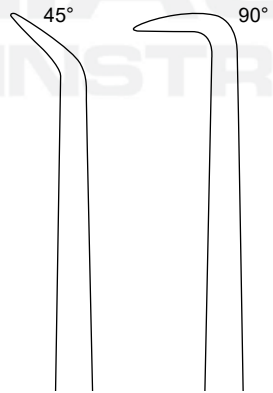

aufgebogen, scharf
angled, sharp

43 cm – 17"

MA 5417-01

MA 5417-02



Stahl-Griff
Steel handle

COBB

1:3



scharf, gebogen
sharp, curved

29 cm – 11½"

10 mm	MA 5412-50
13 mm	MA 5412-51
19 mm	MA 5412-54
25 mm	MA 5412-57
32 mm	MA 5412-60

Raspatorien und Elevatorien Raspatories and Elevators



HOEN



halbscharf,
gebogen
*semi-sharp,
curved*

	16 cm – 6¼"
7 mm	MA 5418-01
	18 cm – 7"
15 mm	MA 5418-03
	19 cm – 7½"
20 mm	MA 5418-05



YANKAUER



gebogen,
stumpf
*curved,
blunt*

	18 cm – 7"
	MA 5419-18



LANGENBECK



gebogen, stumpf
curved, blunt

	20 cm – 8"
MA 5420-20	MA 5421-20



LANGENBECK



gebogen,
stumpf
*curved,
blunt*

	23 cm – 9"
	MA 5422-23

Elevatoren Elevators

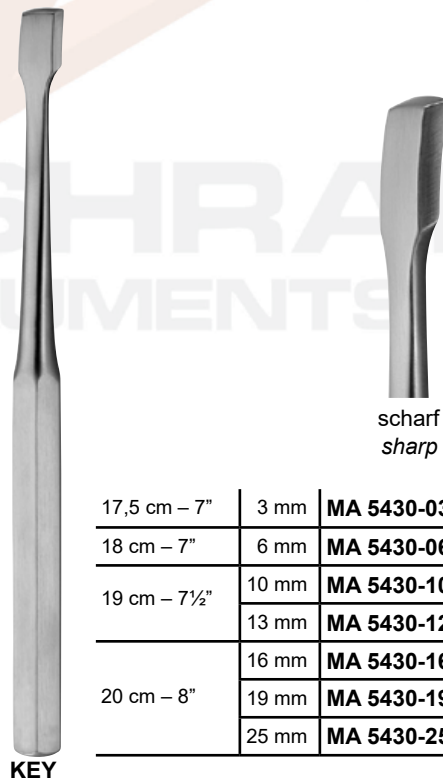
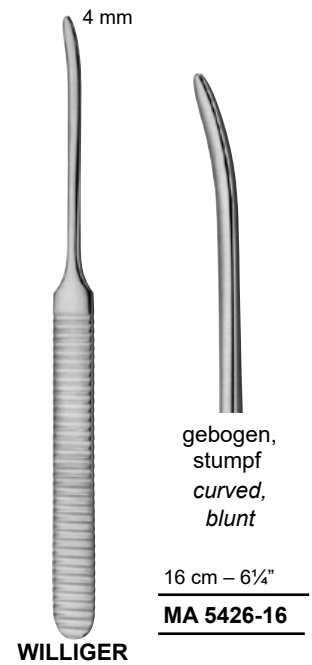

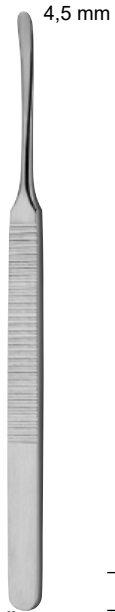

4,5 mm

leicht gebogen,
stumpf
*slightly curved,
blunt*

stark gebogen,
stumpf
*strongly curved,
blunt*

15,5 cm – 6"

MA 5431-01

MA 5431-02

KÖNIG

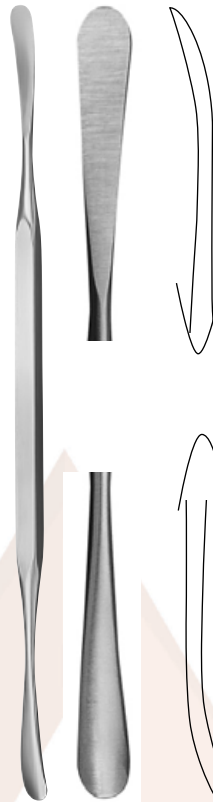

6,5 mm
scharf
sharp

6,5 mm
stumpf
blunt

21 cm – 8¼"

MA 5432-21

ALDERDYCE

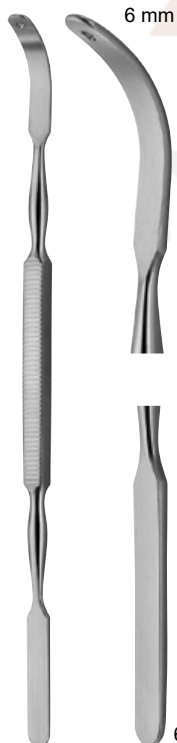

6 mm

stumpf / stumpf
blunt / blunt

18,5 cm – 7¼"

MA 5434-19

6 mm

MC DONALD



11 mm
gebogen
curved

11 mm
gerade
straight

17,5 cm – 7"

MA 5435-17

WATSON-CHEYNE

Knochenheber Bone Levers

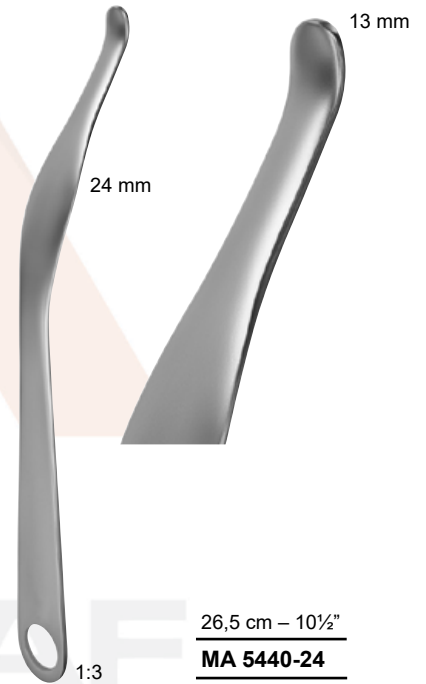
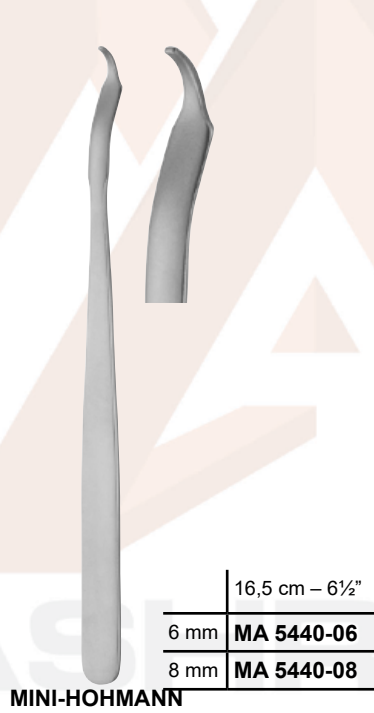
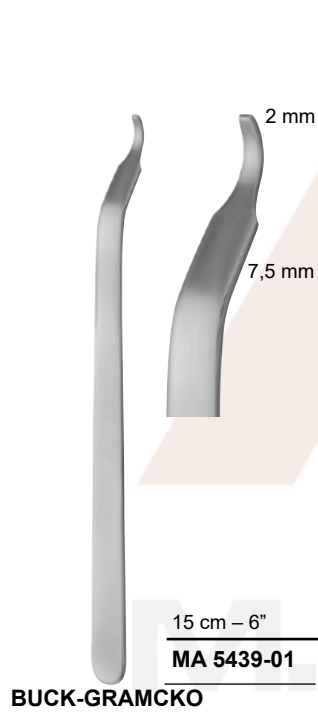

Knochenheber Bone Levers

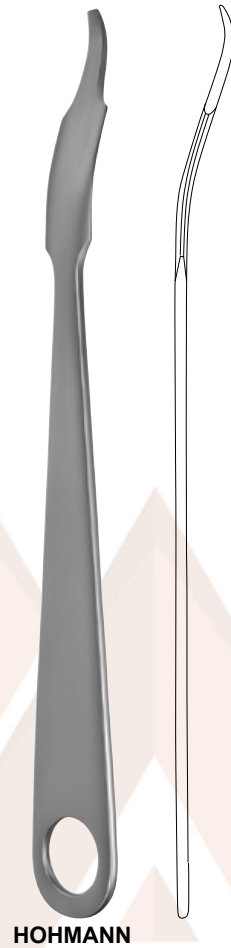

Knochenheber Bone Levers



HOHMANN

24,5 cm – 9¾"
MA 5442-50



HOHMANN

24 cm – 9½"
MA 5442-65



HOHMANN-ALDINGER

27 cm – 10½"
MA 5444-01



VERBRUGGE-MÜLLER

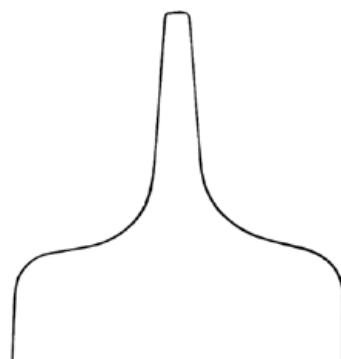

24 cm – 9½"
42 mm **MA 5444-06**



LANE-TRETHOWAN

21,5 cm – 8½"
MA 5444-10

Knochenheber Bone Levers



23 cm – 9"
MA 5444-12

BRISTOW 1:3



32 cm – 12½"
MA 5445-32

MURPHY-LANE 1:3



38 mm

26 cm – 10¼"
MA 5447-01

BLOUNT 1:3



42 mm

26 cm – 10¼"
MA 5447-02

BLOUNT 1:3



24 cm – 9½"

44 mm	MA 5450-44
60 mm	MA 5450-64

BENNETT 1:3

M.ASHRAF
INSTRUMENTS



Knochenhaken Bone Retractors



VOLKMANN

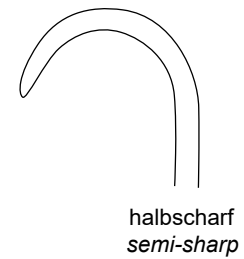
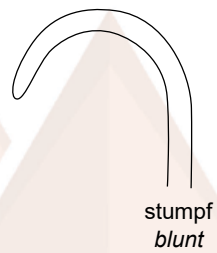
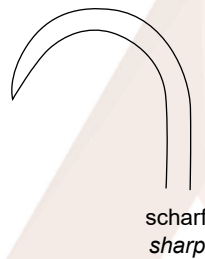

22 cm – 8¾"

MA 4500-01	MA 4501-01	MA 4503-01
-------------------	-------------------	-------------------



VOLKMANN

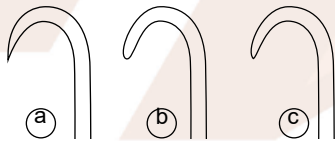

9 x 8 mm



9 x 13 mm



9 x 19 mm



22 cm – 8¾"

(a) scharf / sharp	MA 4500-02	MA 4500-03	MA 4500-04
(b) stumpf / blunt	MA 4501-02	MA 4501-03	MA 4501-04
(c) halbscharf / semi-sharp	MA 4502-02	MA 4502-03	MA 4502-04

9 x 29 mm



9 x 40 mm



22 cm – 8¾"

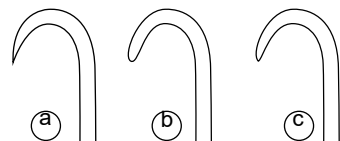

(a) scharf / sharp	MA 4500-06	MA 4500-08
(b) stumpf / blunt	MA 4501-06	MA 4501-08
(c) halbscharf / semi-sharp	MA 4502-06	MA 4502-08

Knochenhaken Bone Retractors



scharf
sharp

24 cm – 9½"

MA 4506-24



KOCHER



scharf
sharp

21,5 cm – 8½"

MA 4506-01



KOCHER



scharf
sharp

21,5 cm – 8½"

MA 4507-01



KOCHER



scharf
sharp

21,5 cm – 8½"

MA 4506-11



KOCHER



scharf
sharp

21,5 cm – 8½"

MA 4507-11

M.ASHRAF
INSTRUMENTS

Knochenhaken Bone Retractors

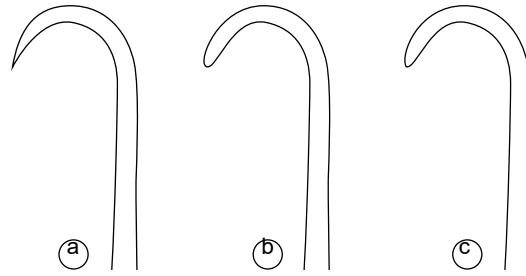

KOCHER

15 x 10 mm

15 x 15 mm

20 x 18 mm



22,5 cm – 8¾"

Ⓐ	scharfsharp	MA 4506-02	MA 4506-03	MA 4506-04
Ⓑ	stumpfblunt	MA 4507-02	MA 4507-03	MA 4507-04
Ⓒ	halbscharfsemi-sharp	MA 4508-02	MA 4508-03	MA 4508-04

15 x 30 mm

15 x 40 mm



22,5 cm – 8¾"

Ⓐ	scharfsharp	MA 4506-06	MA 4506-08
Ⓑ	stumpfblunt	MA 4507-06	MA 4507-08
Ⓒ	halbscharfsemi-sharp	MA 4508-06	MA 4508-08

Spinalhaken, Meniskusmesser Spinal Retractors, Meniscus Knives

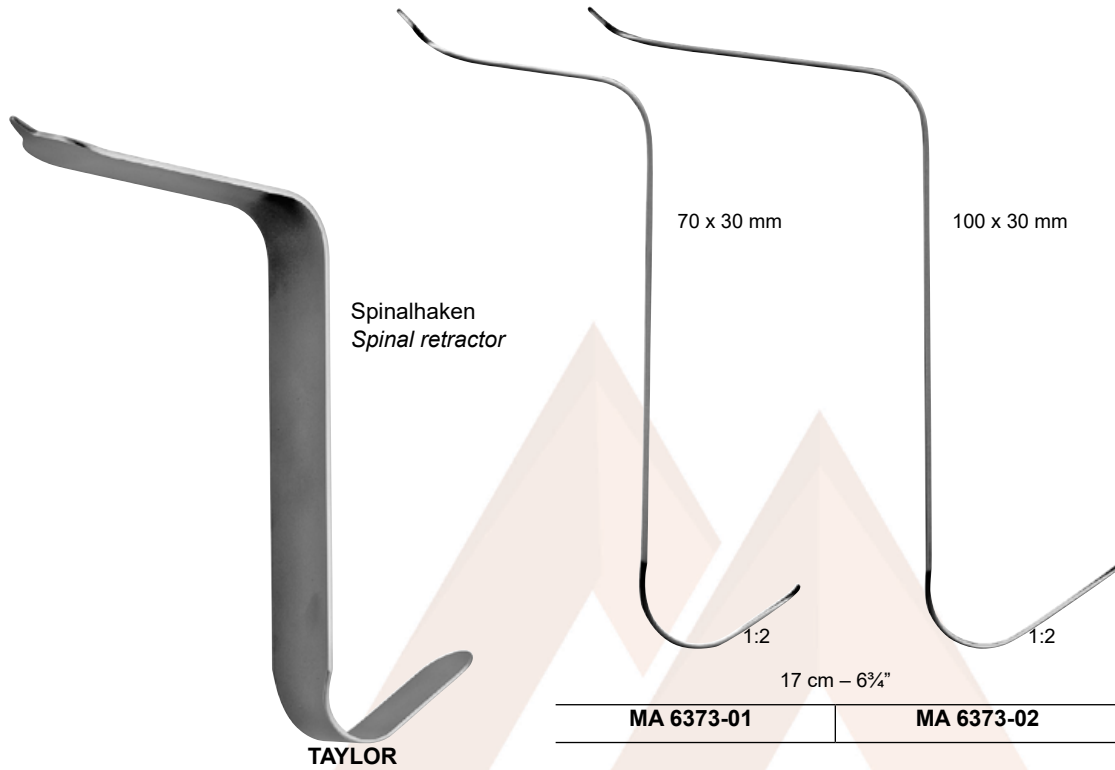

MA 6373-01	MA 6373-02
-------------------	-------------------

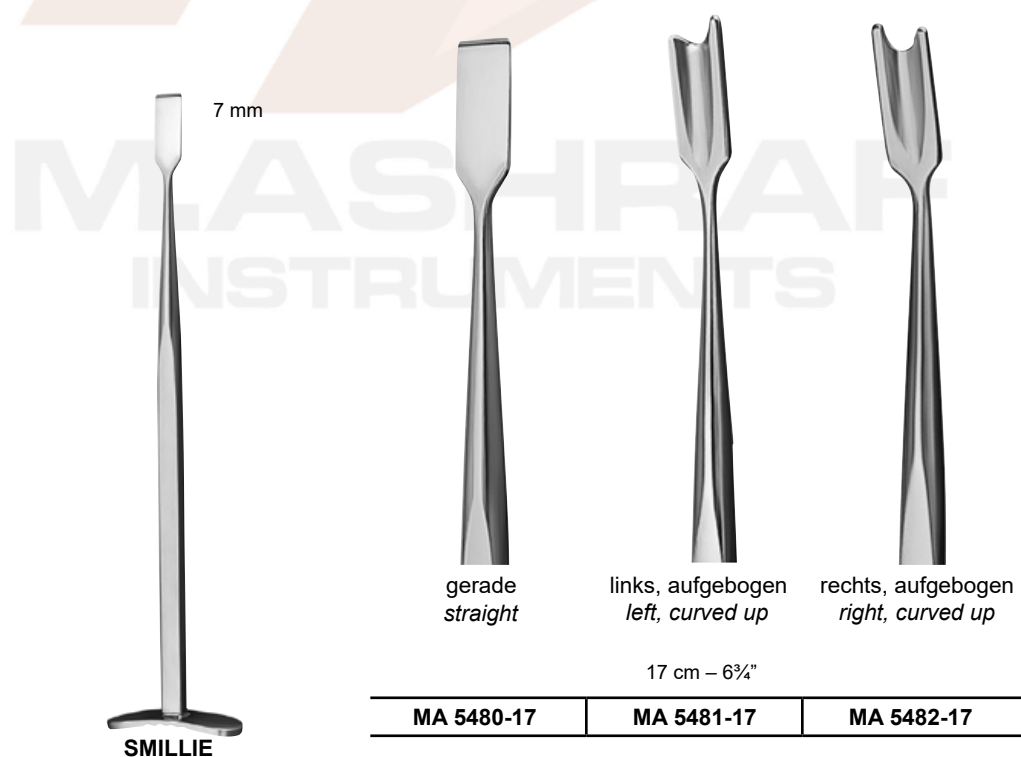

MA 5480-17	MA 5481-17	MA 5482-17
-------------------	-------------------	-------------------

Knochenhaltezangen Bone Holding Forceps



Sequesterzange
Sequestrum forceps



gerade
straight

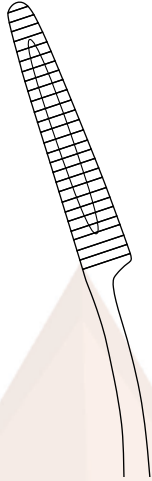

aufgebogen
curved up

20 cm – 8"

MA 5500-20

MA 5501-20



DINGMANN

19 cm – 7½"

MA 5505-19

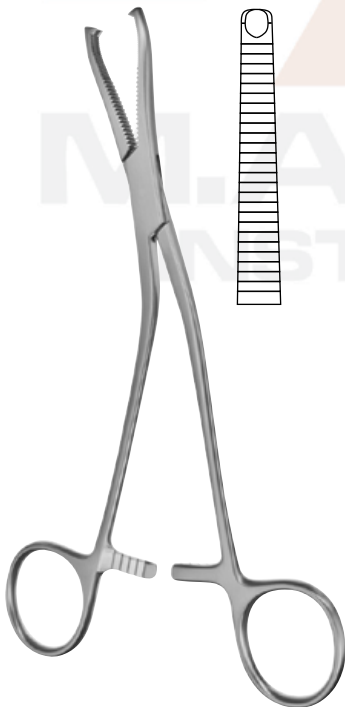

DINGMANN (modif.)

19 cm – 7½"

MA 5506-19

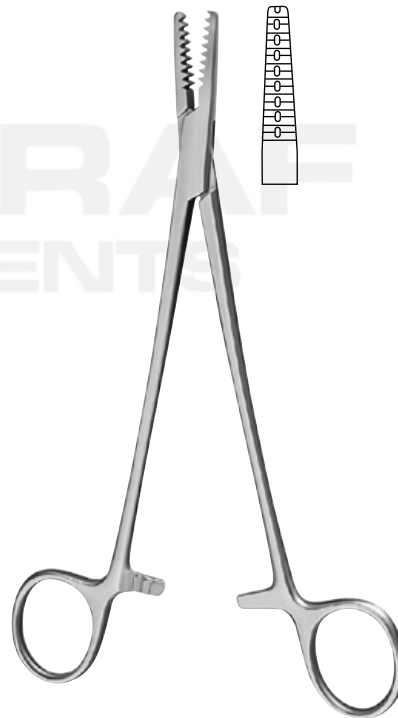

MARTIN

19 cm – 7½"

MA 5508-19

Knochenhaltezangen Bone Holding Forceps



BIRCHER-GANSKE



gerade
straight

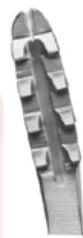

aufgebogen
curved up



seitlich gebogen
curved to side

20 cm – 8"

MA 5510-00

MA 5510-20

MA 5511-20



LEWIN

17,5 cm – 7"

MA 5512-17



LANGENBECK

12 mm



21 cm – 8¼"

MA 5514-21

Knochenhaltezangen Bone Holding Forceps



FERGUSSON

11 mm



21 cm – 8¼"

MA 5516-21



16 cm – 6¼" **MA 5518-16**

24 cm – 9½" **MA 5518-24**



M.ASHRAF
INSTRUMENTS



KERN



ohne Sperre
without ratchet

mit Sperre
with ratchet

17 cm – 6¾" **MA 5520-17**

MA 5521-17

21 cm – 8¼" **MA 5520-21**

MA 5521-21

Knochenhaltezangen Bone Holding Forceps



18 cm – 7"	MA 5522-18
23 cm – 9"	MA 5522-23
25 cm – 10"	MA 5522-25
28 cm – 11"	MA 5522-28

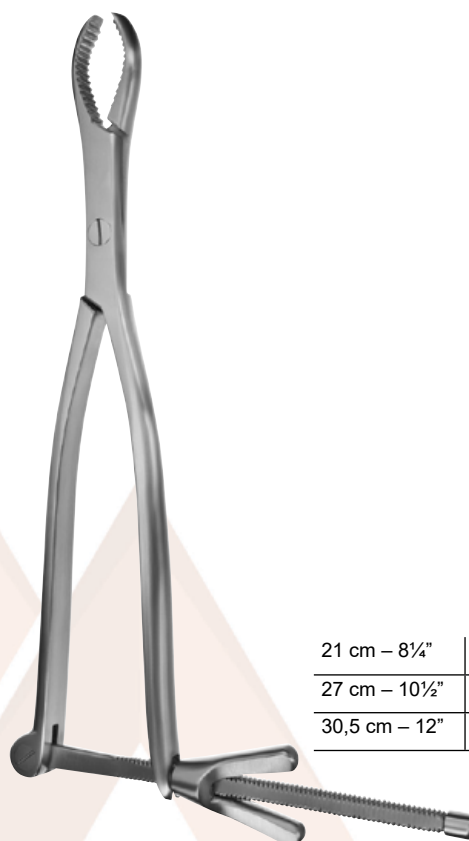

21 cm – 8¼"	MA 5524-21
27 cm – 10½"	MA 5524-27
30,5 cm – 12"	MA 5524-30

HEY GROVES



8 mm

SEMB

19 cm – 7½"	MA 5525-19
-------------	-------------------



7,5 mm

SEMB

19 cm – 7½"	MA 5525-51
-------------	-------------------

M.ASHRAF
INSTRUMENTS

Knochenhaltezangen Bone Holding Forceps

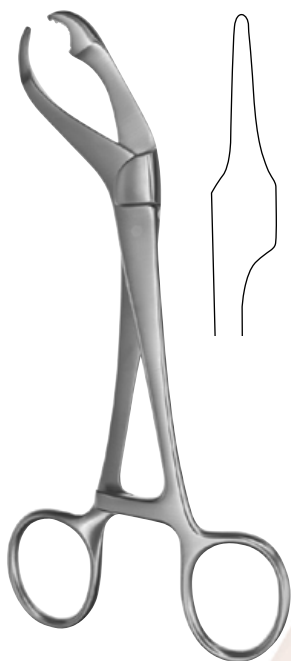

VERBRUGGE



kleines Modell
small pattern

17,5 cm – 7"

MA 5527-17



VERBRUGGE



25 cm – 10"

MA 5527-25



26 cm – 10¼"

MA 5527-26



27 cm – 10½"

MA 5527-27

mit Lappenverschluss
with lip joint

Knochenhaltezangen Bone Holding Forceps



15 cm – 6"	MA 5528-15
19 cm – 7½"	MA 5528-19
24 cm – 9½"	MA 5528-24
26 cm – 10¼"	MA 5528-26
28 cm – 11"	MA 5528-28



Amputationsretraktor,
Griffe abnehmbar
*Amputation retractor,
removeable handles*

PERCY
MA 5529-30

1:4



FARABEU-F-LAMBOTTE

26 cm – 10¼"
MA 5533-26



LAMBOTTE

19 cm – 7½" **MA 5535-19**
23 cm – 9" **MA 5535-23**
26 cm – 10¼" **MA 5535-26**

Knochenhaltezangen Bone Holding Forceps



LANE

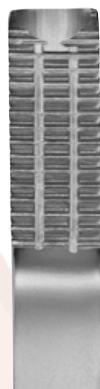

ohne Sperre
without ratchet

mit Sperre
with ratchet

33 cm – 13"	MA 5534-33	MA 5536-33
26 cm – 10¼"	MA 5534-45	MA 5536-45



14,5 cm – 5¾"
MA 5537-14



13,5 cm – 5¼"
MA 5538-12

Knochenhaltezangen Bone Holding Forceps



13,5 cm – 5¼"
MA 5539-13

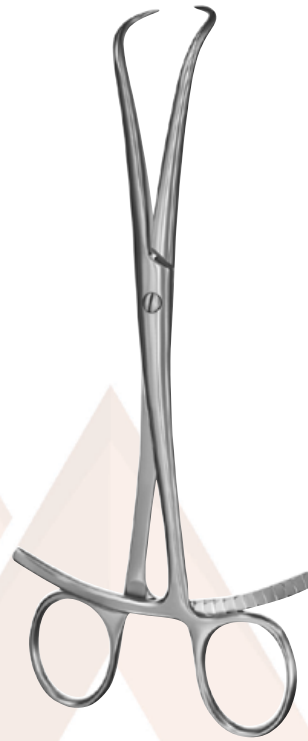

20 cm – 8"
MA 5539-20



17 cm – 6¾"
MA 5540-17



Patellazange
Patella forceps

17,5 cm – 7"
MA 5540-01

M.ASHRAF
INSTRUMENTS

Knochenhaltezangen Bone Holding Forceps



LOWMAN

18 cm – 7"	MA 5542-18
20 cm – 8"	MA 5542-20
22 cm – 8¾"	MA 5542-22



MINI-LOWMAN

12 cm – 4¾"	MA 5543-12
-------------	-------------------

M.ASHRAF
INSTRUMENTS

Hohlmeißelzangen Bone Rongeurs



STELLBRINK



leicht gebogen
slightly curved



gebogen
curved

17 cm – 6¾"

MA 5558-01

MA 5558-02

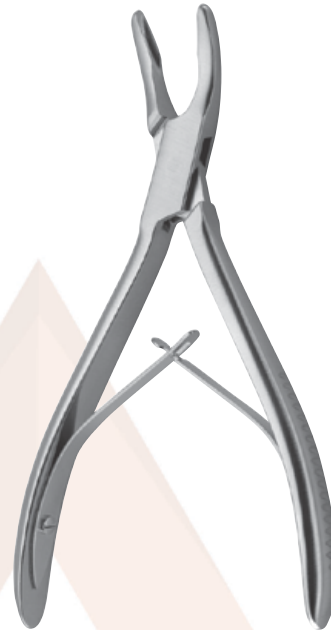

BANE-HARTMANN



gebogen
curved

17,5 cm – 7"

MA 5559-17

M.ASHRAF
INSTRUMENTS



MINI-FRIEDMANN



gebogen
curved

12,5 cm – 5"

MA 5560-12



LUER-FRIEDMANN



leicht gebogen
slightly curved

14 cm – 5½"

MA 5560-14

Hohlmeißelzangen Bone Rongeurs



FRIEDMANN-DELIKAT

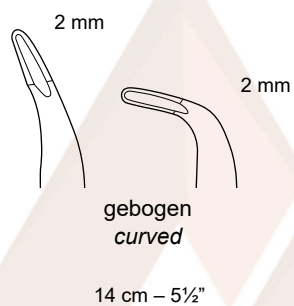

14 cm – 5½"

MA 5561-15 | MA 5561-90



CLEVELAND



gebogen-
curved

14 cm – 5½" | MA 5562-14

17 cm – 6¾" | MA 5562-17



HARTMANN

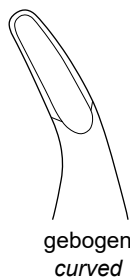

18,5 cm – 7¼"

MA 5563-18



OLIVECRONA

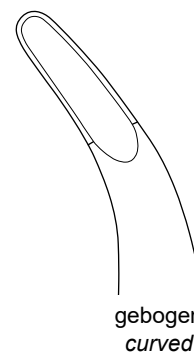

20 cm – 8"

MA 5565-20

Hohlmeißelzangen Bone Rongeurs

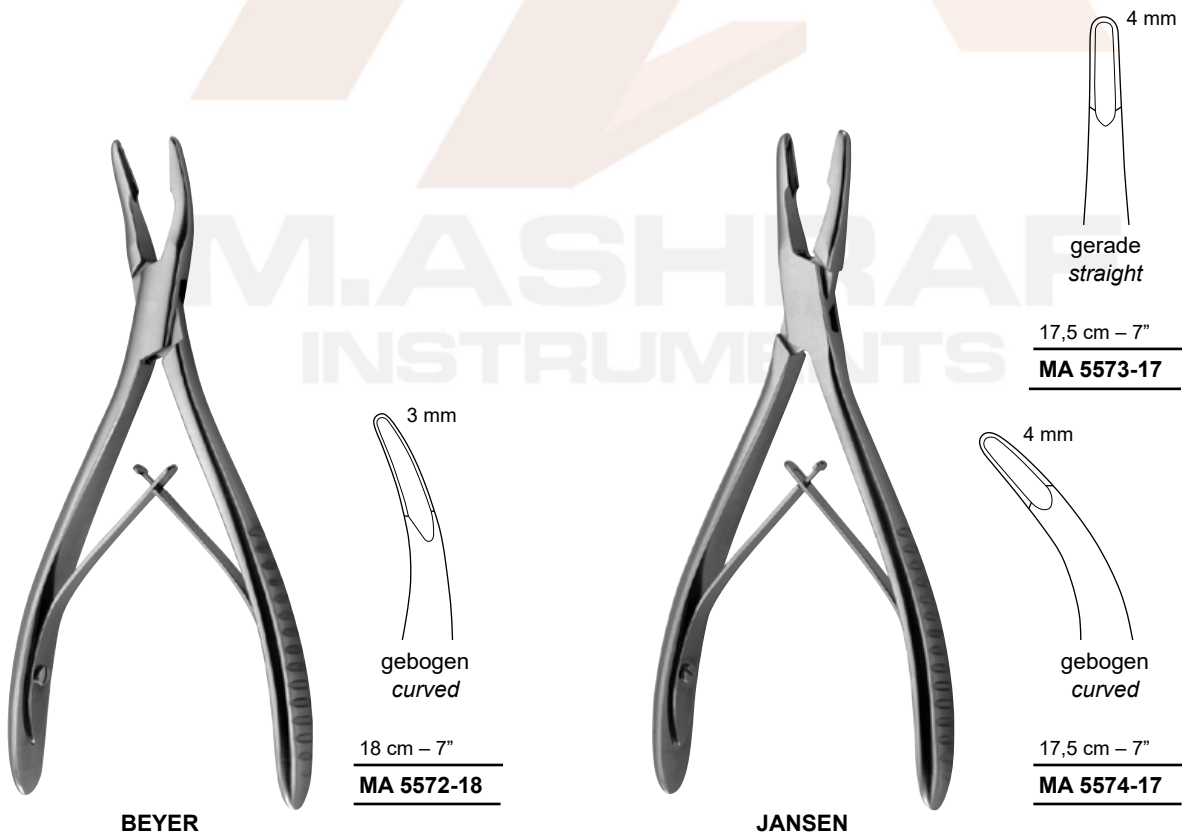
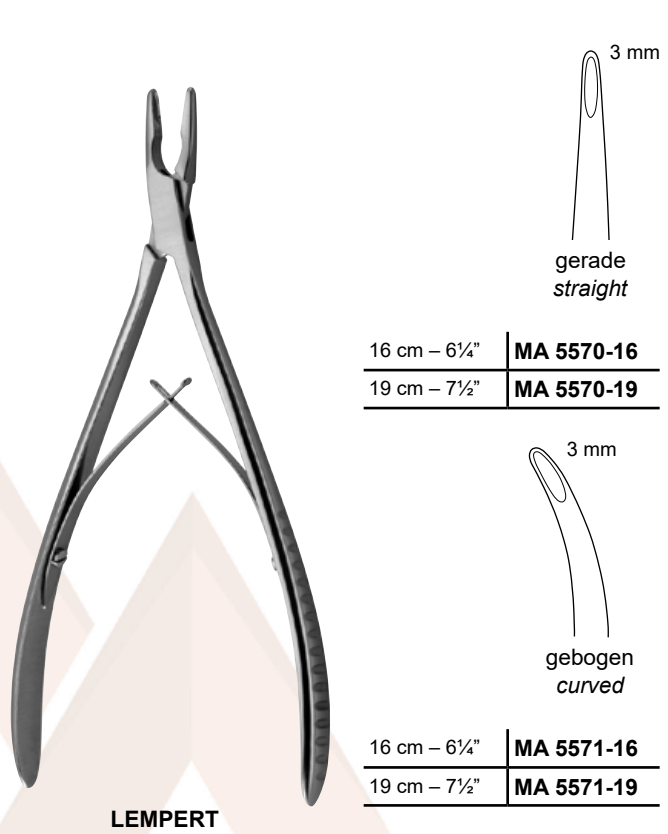
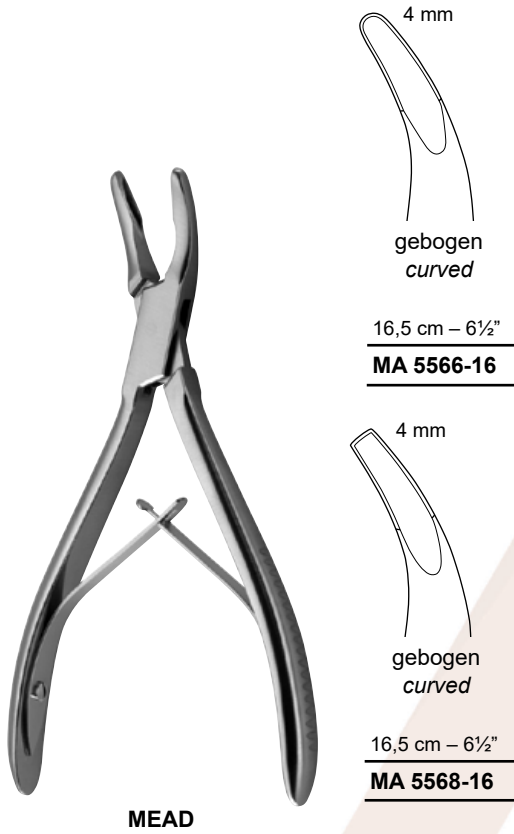

Hohlmeißelzangen Bone Rongeurs



BLUMENTHAL



leicht gebogen
slightly curved

15,5 cm – 6"

MA 5575-01



gebogen
curved

15 cm – 6"

MA 5575-02



HAKANSSON

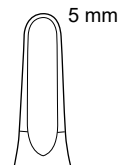

seitlich gebogen
curved laterally

16 cm – 6¼"

MA 5576-15



JANSEN

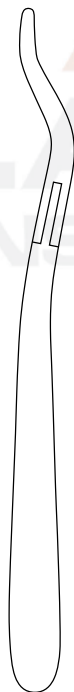

4 mm

S-gebogen
S-curved

18 cm – 7"

MA 5576-19



COTTLE-JANSEN

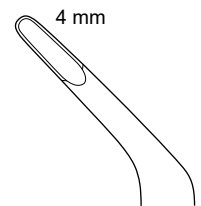

4 mm

gebogen
curved

17 cm – 6¾"

MA 5579-01

Hohlmeißelzangen Bone Rongeurs

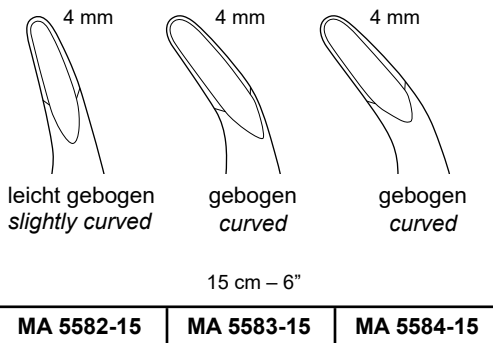
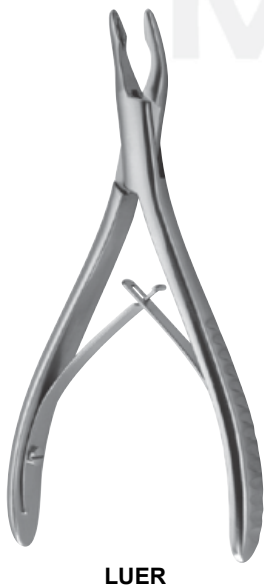
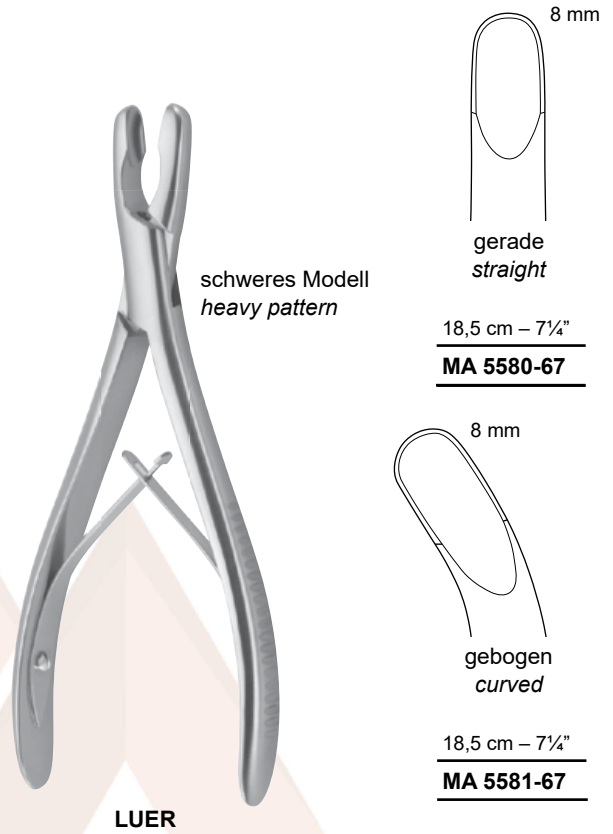
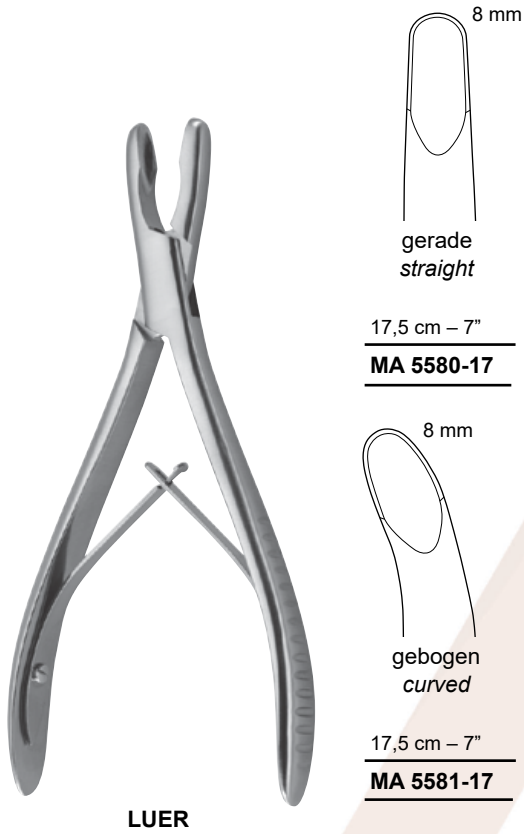

M.ASHRAF
INSTRUMENTS



Hohlmeißelzangen Bone Rongeurs

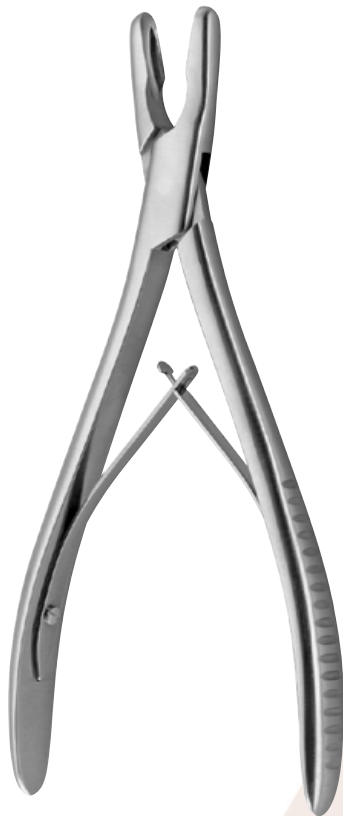

ADSON

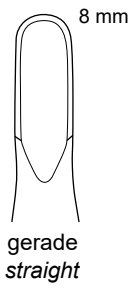

20,5 cm – 8"

MA 5585-01



20,5 cm – 8"

MA 5585-02

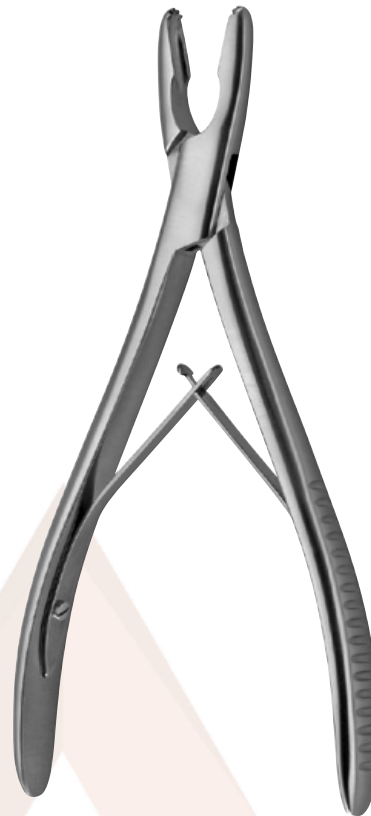

ADSON

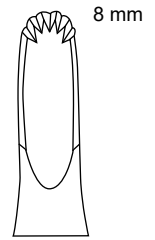

20,5 cm – 8"

MA 5585-21



KLEINERT-KUTZ

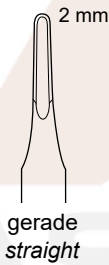

15 cm – 6"

MA 5587-02



15 cm – 6"

MA 5587-12



BÖHLER

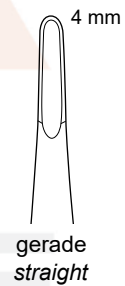

MA 5588-15

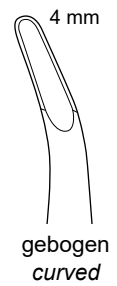

15,5 cm – 6"

MA 5589-15

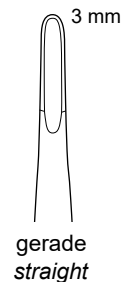

MA 5588-03

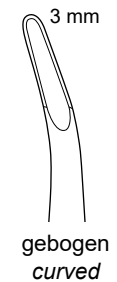

15,5 cm – 6"

MA 5589-13

Hohlmeißelzangen Bone Rongeurs



ZAUFAL-JANSEN



gebogen
curved

18 cm – 7"

MA 5590-18

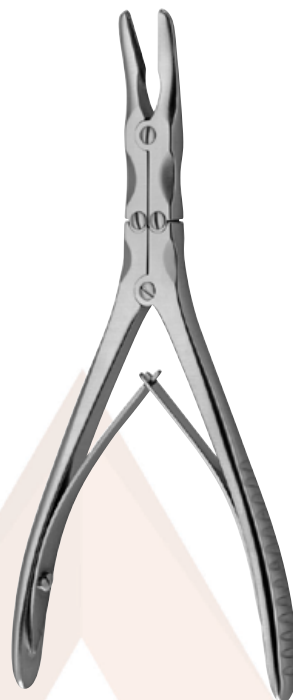

BEYER

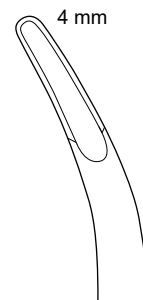

4 mm

gebogen
curved

18 cm – 7"

MA 5592-18



MAYFIELD

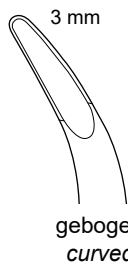

3 mm

gebogen
curved

17,5 cm – 7"

MA 5593-17



RUSKIN



gerade
straight

18 cm – 7"

MA 5594-02

Hohlmeißelzangen Bone Rongeurs



RUSKIN

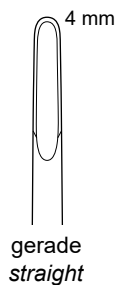

18 cm – 7"	MA 5594-24	MA 5594-34
------------	-------------------	-------------------

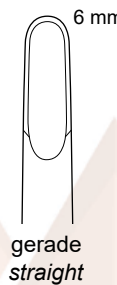

18 cm – 7"	MA 5594-51	MA 5594-18
23,5 cm – 9¼"	MA 5594-53	MA 5594-23



MARQUARDT



20 cm – 8"	MA 5595-20
------------	-------------------



RÖTTGEN-RUSKIN

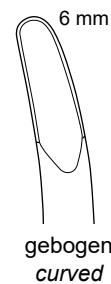

24 cm – 9½"	MA 5596-24
-------------	-------------------

Hohlmeißelzangen Bone Rongeurs



SMITH-PETERSEN

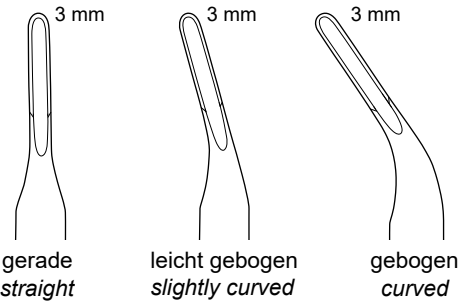

24 cm – 9½"

MA 5597-03	MA 5597-13	MA 5597-23
------------	------------	------------

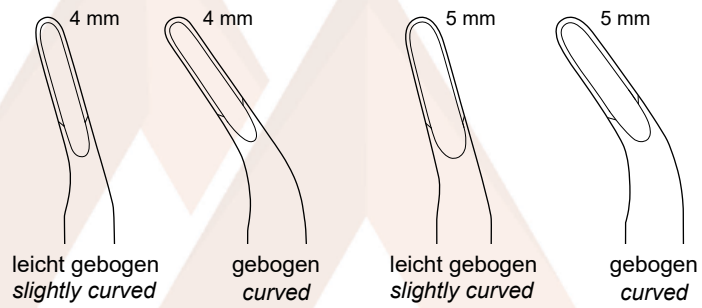

24 cm – 9½"

MA 5597-14	MA 5597-24	MA 5597-15	MA 5597-25
------------	------------	------------	------------

M.ASHRAF
INSTRUMENTS

Hohlmeißelzangen Bone Rongeurs



STILLE-LUER



gerade
straight



gebogen
curved

22 cm – 8 3/4"

MA 5600-22

MA 5601-22



STILLE-LUER

1:3

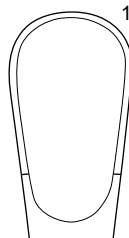

gerade
straight

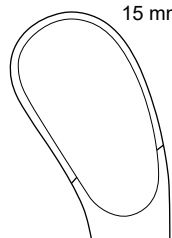

gebogen
curved

27 cm – 10 1/2"

MA 5600-27

MA 5601-27

Hohlmeißelzangen Bone Rongeurs

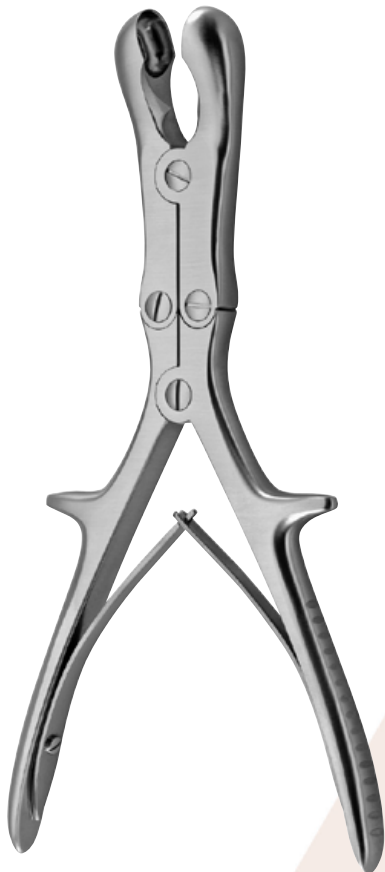

SEMB

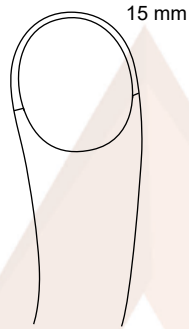

gebogen
curved

23 cm – 9"

MA 5602-23



STILLE-RUSKIN

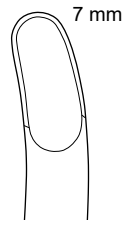

gebogen
curved

24 cm – 9½"

MA 5604-23

M.ASHRAF
INSTRUMENTS



LEKSELL

1:3

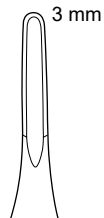

3 mm

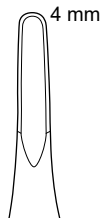

4 mm

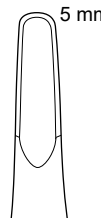

5 mm

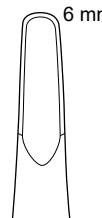

6 mm

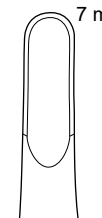

7 mm

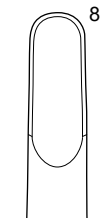

8 mm

seitlich gebogen
curved sideways

23,5 cm – 9¼"

MA 5606-03

MA 5606-04

MA 5606-05

MA 5606-06

MA 5606-07

MA 5606-08

Hohlmeißelzangen Bone Rongeurs



LEKSELL

1:3

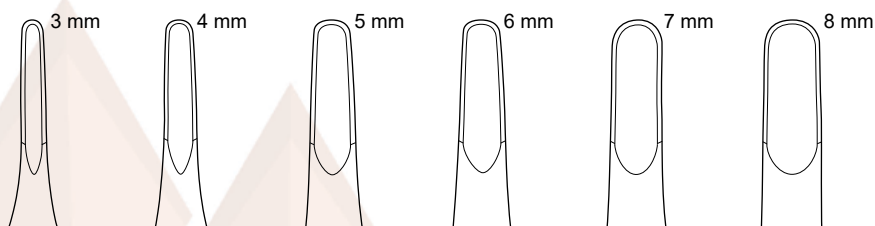

seitlich gebogen
curved sideways

23 cm – 9"

MA 5606-13	MA 5606-14	MA 5606-15	MA 5606-16	MA 5606-17	MA 5606-18
------------	------------	------------	------------	------------	------------



STILLE

1:3

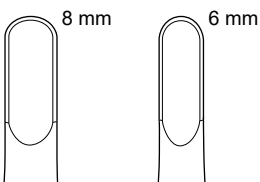

seitlich gebogen
curved sideways

23 cm – 9"

MA 5608-08	MA 5608-23
------------	------------

Knochensplitterzangen Bone Cutting Forceps



LISTON



gerade
straight

gebogen
curved

14 cm – 5½"	MA 5640-14	MA 5641-14
17 cm – 6¾"	MA 5640-17	MA 5641-17
20 cm – 8"	MA 5640-19	MA 5641-19
22 cm – 8¾"	MA 5640-22	MA 5641-22



LITTAUER-LISTON



15 cm – 6"

MA 5642-15



BÖHLER

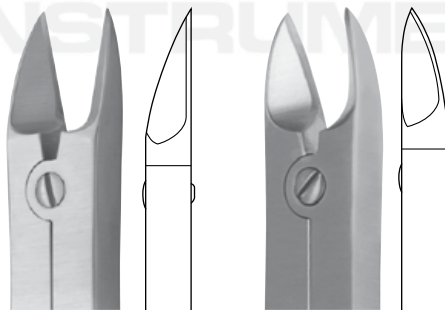

gerade
straight

gebogen
curved

15 cm – 6"

MA 5700-15	MA 5701-15
-------------------	-------------------

M.ASHRAF
INSTRUMENTS

Knochensplitterzangen Bone Cutting Forceps



MC INDOE



17,5 cm – 7"

MA 5702-17



KAZANJIAN



18 cm – 7"

MA 8125-18



RUSKIN-LISTON

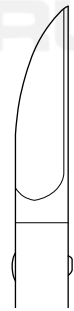

gerade
straight

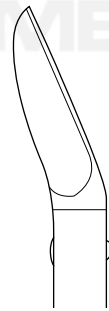

gebogen
curved

8,5 cm – 7¼"

MA 5710-18

MA 5711-18

Knochensplitterzangen Bone Cutting Forceps



STILLE-LISTON

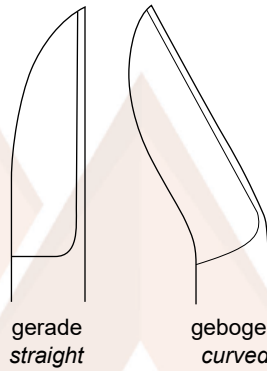

gerade
straight

gebogen
curved

23 cm – 9"	MA 5716-23	MA 5717-23
27 cm – 10½"	MA 5716-27	MA 5717-27



LISTON-KEY-HORSLEY

S-gebogen
S-curved



27 cm – 10½"
MA 5718-27

1:3

Instrumente für Fingernägel

Nail Instruments

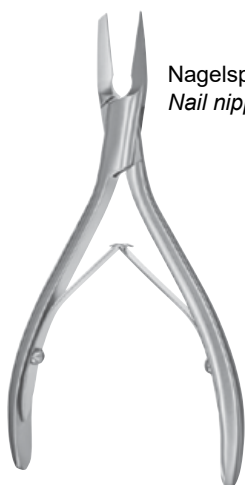

Nagelspaltzange
Nail nipper

13,5 cm – 5¼"

MA 5722-13



Rundzange
Round pliers

18 cm – 7"

MA 5723-04

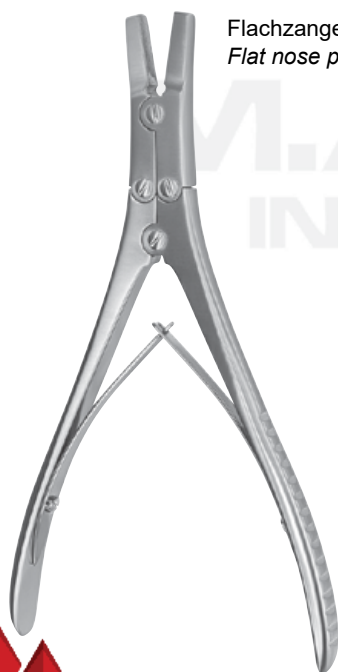

Flachzange
Flat nose pliers

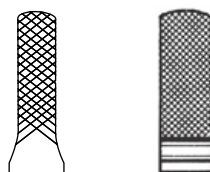

18 cm – 7"

MA 5723-18

MA 5724-18



Nagelausreißzange
Nail pulling forceps



13,5 cm – 5¼"

MA 5726-13

RADOLF

Sägen und Sägeblätter

Saws and Saw Blades



Sägeblatt, allein
Saw blade, only

MA 5727-21



Sägeblatt, allein,
für Hartmetall nicht geeignet
*Saw blade, only,
not suitable for carbide metal*

MA 5728-21

Fingerringsäge,
kompl. mit 1 Sägeblatt
*Finger ring saw,
compl. with 1 saw blade*

17 cm – 6¾"

MA 5727-17

Fingerringsäge,
kompl. mit 1 Sägeblatt
*Finger ring saw,
compl. with 1 saw blade*

15 cm – 6"

MA 5728-17

Sägeblatt, allein
Saw blade, only

MA 5732-99



1:3
LANGENBECK

23 cm – 9"

MA 5730-23



1:3
SATTERLEE

31 cm – 12¼"

MA 5732-31

Sägen und Sägeblätter Saws and Saw Blades



Sägeblatt, allein
Saw blade, only

MA 5735-99

27 cm – 10½"

MA 5735-27

1:3

CHARRIÈRE



Säge komplett, bestehend aus:
Saw complete, consisting of:

MA 5736-35

1 Säge 35 cm – 13¾"
1 Saw 35 cm – 13¾"

1 Sägeblatt 12 mm (MA 5736-42)
1 Saw blade 12 mm (MA 5736-42)

1 Sägeblatt 15 mm (MA 5736-45)
1 Saw blade 15 mm (MA 5736-45)

Blattbreite Blade width	Sägeblätter Saw blades
12 mm	MA 5736-42
15 mm	MA 5736-45

CHARRIÈRE

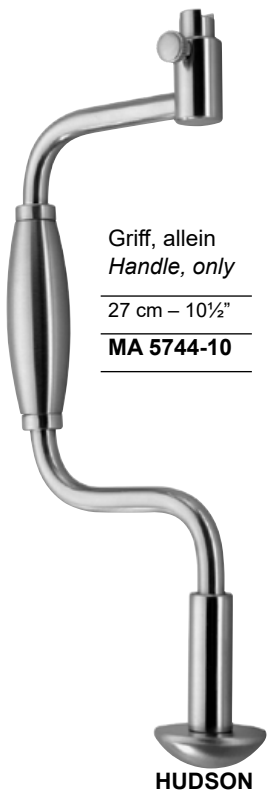

Griff, allein
Handle, only

27 cm – 10½"

MA 5744-10



Fig. 9

Verlängerungsstück
Extension piece

7,5 cm – 3"

MA 5744-09

HUDSON

Bohrapparat komplett, bestehend aus:
Hand drill complete, consisting of:

MA 5744-00

Griff, allein (MA 5744-10)
Handle, only (MA 5744-10)

Fräser Fig. 1 (MA 5744-01)
Cutter Fig. 1 (MA 5744-01)

Fräser Fig. 2 (MA 5744-02)
Cutter Fig. 2 (MA 5744-02)

Fräser Fig. 3 (MA 5744-03)
Cutter Fig. 3 (MA 5744-03)

Fräser Fig. 4 (MA 5744-04)
Cutter Fig. 4 (MA 5744-04)

Verlängerungsstück Fig. 9 (MA 5744-09)
Extension piece Fig. 9 (MA 5744-09)



HUDSON

CUSHING

MC KENZIL ERRICO

Fig. 1	Fig. 2	Fig. 3	Fig. 4	Fig. 5			
Ø 9 mm	Ø 14 mm	Ø 16 mm	Ø 22 mm	Ø 14 mm	Ø 2 mm	Ø 13 mm	Ø 16 mm
MA 5744-01	MA 5744-02	MA 5744-03	MA 5744-04	MA 5744-05	MA 5744-06	MA 5744-07	MA 5744-08

Bohrapparate Hand Drills

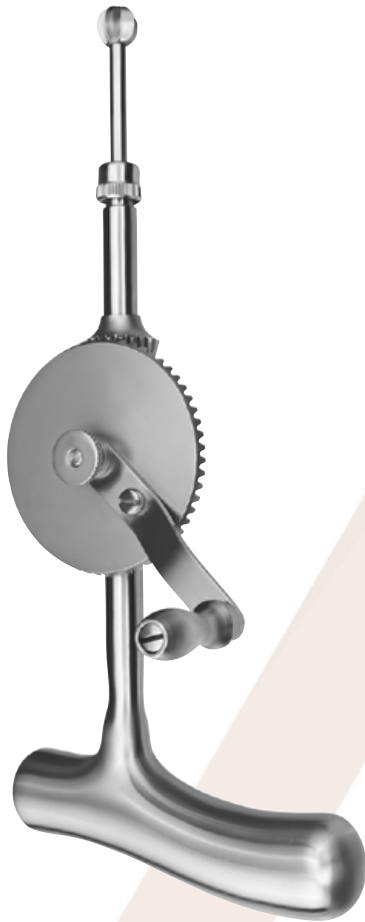

STILLE

Bohrapparat komplett, bestehend aus:
Hand drill complete, consisting of:

MA 5746-00

Griff, allein 24 cm – 9½" (MA 5746-10)
Handle, only 24 cm – 9½" (MA 5746-10)

Bohrer Fig. 1 (MA 5746-01)
Drill Fig. 1 (MA 5746-01)

Bohrer Fig. 2 (MA 5746-02)
Drill Fig. 2 (MA 5746-02)

Bohrer Fig. 3 (MA 5746-03)
Drill Fig. 3 (MA 5746-03)

Bohrer Fig. 4 (MA 5746-04)
Drill Fig. 4 (MA 5746-04)

Bohrer Fig. 5 (MA 5746-05)
Drill Fig. 5 (MA 5746-05)

Fräser Fig. 6 (MA 5746-06)
Cutter Fig. 6 (MA 5746-06)

Fräser Fig. 7 (MA 5746-07)
Cutter Fig. 7 (MA 5746-07)

Fräser Fig. 8 (MA 5746-08)
Cutter Fig. 8 (MA 5746-08)

Fräser Fig. 9 (MA 5746-09)
Cutter Fig. 9 (MA 5746-09)

Griff, allein
Handle, only

24 cm – 9½"

MA 5746-10



Fig. 1	Fig. 2	Fig. 3	Fig. 4	Fig. 5	Fig. 6	Fig. 7	Fig. 8	Fig. 9
Ø 2,5 mm	Ø 3 mm	Ø 3,5 mm	Ø 4 mm	Ø 10 mm	Ø 5 mm	Ø 8 mm	Ø 12 mm	Ø 16 mm
MA 5746-01	MA 5746-02	MA 5746-03	MA 5746-04	MA 5746-05	MA 5746-06	MA 5746-07	MA 5746-08	MA 5746-09



Bohrapparat mit umstellbarem Handgriff:
Hand drill with adjustable handle:

MA 5746-50

1 Dreibackenspannfutter
1 Three-jaw-chuck
1 Schlüssel
1 Wrench



Handgriff mit Jacobs-Spannfutter
0,5 - 7 mm und Spanschlüssel, allein
*Handle with Jacobs chuck 0.5 - 7 mm
and wrench, only*

MA 5747-01

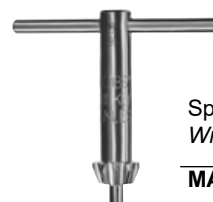

Spanschlüssel, allein
Wrench, only

MA 5747-11

Reibahlen
Reamers

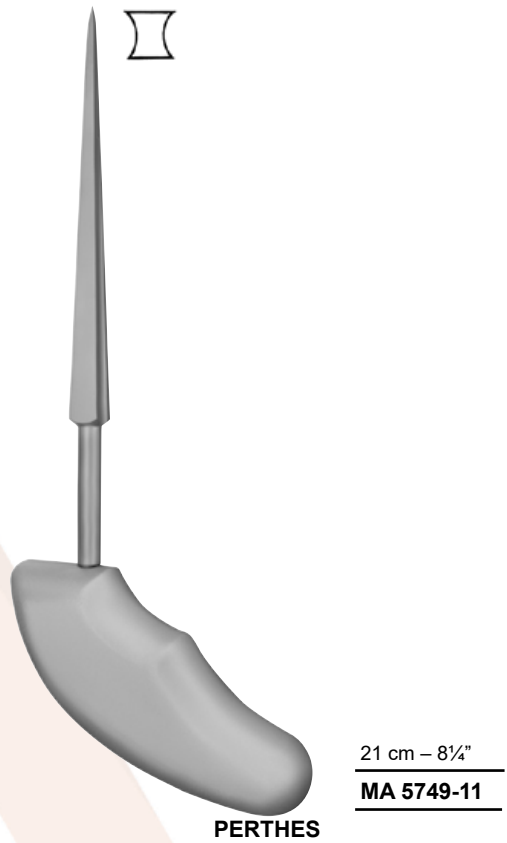
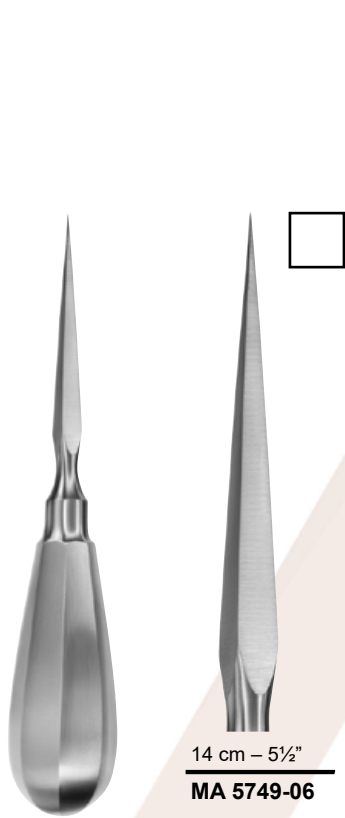

M.ASHRAF
INSTRUMENTS



Bohrdrähte, Steinmann-Nägel Drill Wires, Steinmann Pins



Trokarspitze, mit flachem Ende
(Verpackungseinheit à 10 Stück)
Trocar point, with flat shaft
(Packing unit 10 pieces)

1:1
KIRSCHNER

Ø mm	Länge Length			
	60 mm – 2½"	100 mm – 4"	155 mm – 6"	310 mm – 12¼"
0,8	MA 5750-08	MA 5751-08	MA 5754-08	MA 5755-08
1	MA 5750-10	MA 5751-10	MA 5754-10	MA 5755-10
1,1	MA 5750-11	MA 5751-11	MA 5754-11	MA 5755-11
1,2	MA 5750-12	MA 5751-12	MA 5754-12	MA 5755-12
1,4	MA 5750-14	MA 5751-14	MA 5754-14	MA 5755-14
1,5	MA 5750-15	MA 5751-15	MA 5754-15	MA 5755-15
1,6	MA 5750-16	MA 5751-16	MA 5754-16	MA 5755-16
1,7	MA 5750-17	MA 5751-17	MA 5754-17	MA 5755-17
1,8	MA 5750-18	MA 5751-18	MA 5754-18	MA 5755-18
1,9	MA 5750-19	MA 5751-19	MA 5754-19	MA 5755-19
2	MA 5750-20	MA 5751-20	MA 5754-20	MA 5755-20
2,2	MA 5750-22	MA 5751-22	MA 5754-22	MA 5755-22
2,5	MA 5750-25	MA 5751-25	MA 5754-25	MA 5755-25
2,8	MA 5750-28	MA 5751-28	MA 5754-28	MA 5755-28
3	MA 5750-30	MA 5751-30	MA 5754-30	MA 5755-30



Trokarspitze, mit rundem Ende
(Verpackungseinheit à 10 Stück)
Trocar point, with round shaft
(Packing unit 10 pieces)

1:1

Ø mm	Länge Length			
	60 mm – 2½"	100 mm – 4"	155 mm – 6"	310 mm – 12¼"
0,8	MA 5750-38	MA 5751-38	MA 5754-38	MA 5755-38
1	MA 5750-40	MA 5751-40	MA 5754-40	MA 5755-40
1,1	MA 5750-41	MA 5751-41	MA 5754-41	MA 5755-41
1,2	MA 5750-42	MA 5751-42	MA 5754-42	MA 5755-42
1,4	MA 5750-44	MA 5751-44	MA 5754-44	MA 5755-44
1,5	MA 5750-45	MA 5751-45	MA 5754-45	MA 5755-45
1,6	MA 5750-46	MA 5751-46	MA 5754-46	MA 5755-46
1,7	MA 5750-47	MA 5751-47	MA 5754-47	MA 5755-47
1,8	MA 5750-48	MA 5751-48	MA 5754-48	MA 5755-48
1,9	MA 5750-49	MA 5751-49	MA 5754-49	MA 5755-49
2	MA 5750-50	MA 5751-50	MA 5754-50	MA 5755-50
2,2	MA 5750-52	MA 5751-52	MA 5754-52	MA 5755-52
2,5	MA 5750-55	MA 5751-55	MA 5754-55	MA 5755-55
2,8	MA 5750-58	MA 5751-58	MA 5754-58	MA 5755-58
3	MA 5750-60	MA 5751-60	MA 5754-60	MA 5755-60

Bohrdrähte, Steinmann-Nägel

Drill Wires, Steinmann Pins



Trokarspitze, mit Trokarende
(Verpackungseinheit à 10 Stück)

*Trocar point, with trocar shaft
(Packing unit 10 pieces)*

Ø mm	Länge Length		
	100 mm – 4"	155 mm – 6"	310 mm – 12¼"
0,8	MA 5756-08	MA 5756-38	MA 5756-68
1	MA 5756-10	MA 5756-40	MA 5756-70
1,1	MA 5756-11	MA 5756-41	MA 5756-71
1,2	MA 5756-12	MA 5756-42	MA 5756-72
1,4	MA 5756-14	MA 5756-44	MA 5756-74
1,5	MA 5756-15	MA 5756-45	MA 5756-75
1,6	MA 5756-16	MA 5756-46	MA 5756-76
1,7	MA 5756-17	MA 5756-47	MA 5756-77
1,8	MA 5756-18	MA 5756-48	MA 5756-78
1,9	MA 5756-19	MA 5756-49	MA 5756-79
2	MA 5756-20	MA 5756-50	MA 5756-80
2,2	MA 5756-22	MA 5756-52	MA 5756-82
2,5	MA 5756-25	MA 5756-55	MA 5756-85
2,8	MA 5756-28	MA 5756-58	MA 5756-88
3	MA 5756-30	MA 5756-60	MA 5756-90

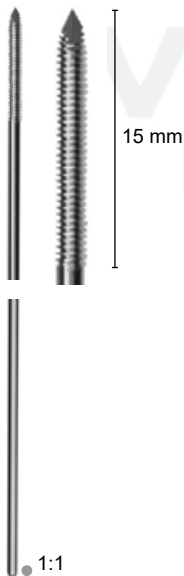

Trokarspitze, mit Gewinde
(Verpackungseinheit à 10 Stück)

*Trocar point, with thread
(Packing unit 10 pieces)*

Ø mm	Länge Length	
	155 mm – 6"	310 mm – 12¼"
1,2	MA 5754-72	MA 5755-72
1,4	MA 5754-74	MA 5755-74
1,6	MA 5754-76	MA 5755-76
1,8	MA 5754-78	MA 5755-78
2	MA 5754-80	MA 5755-80
2,2	MA 5754-82	MA 5755-82
2,5	MA 5754-85	MA 5755-85

Bohrdrähte, Steinmann-Nägel Drill Wires, Steinmann Pins



Lanzenspitze
(Verpackungseinheit à 10 Stück)
Lance point
(Packing unit 10 pieces)

1:1

	Länge Length
Ø mm	310 mm – 12¼"
0,8	MA 5758-08
0,9	MA 5758-09
1	MA 5758-10
1,1	MA 5758-11
1,2	MA 5758-12
1,3	MA 5758-13
1,4	MA 5758-14
1,5	MA 5758-15
1,6	MA 5758-16
1,7	MA 5758-17
1,8	MA 5758-18
1,9	MA 5758-19
2	MA 5758-20
2,2	MA 5758-22
2,4	MA 5758-24
2,5	MA 5758-25
2,6	MA 5758-26
2,8	MA 5758-28
3	MA 5758-30



Trokarspitze, mit 3-kant Ende
Trocar point, with triangular end

M.ASHRAF
INSTRUMENTS

1:1

Länge Length	Ø 4 mm	Ø 4,5 mm	Ø 5 mm
8 cm	MA 5784-08	MA 5785-08	MA 5786-08
10 cm	MA 5784-10	MA 5785-10	MA 5786-10
12 cm	MA 5784-12	MA 5785-12	MA 5786-12
14 cm	MA 5784-14	MA 5785-14	MA 5786-14
16 cm	MA 5784-16	MA 5785-16	MA 5786-16
18 cm	MA 5784-18	MA 5785-18	MA 5786-18
20 cm	MA 5784-20	MA 5785-20	MA 5786-20
22 cm	MA 5784-22	MA 5785-22	MA 5786-22
25 cm	MA 5784-25	MA 5785-25	MA 5786-25
30 cm	MA 5784-30	MA 5785-30	MA 5786-30

STEINMANN

Drahtspannzangen Wire Twisting Forceps



14 cm – 5½"
MA 5760-14



16 cm – 6¼"
MA 5760-16



Körnung 0,5 mm
Grit 2500 tpsi



Typ / Type	18 cm – 7"	
TC	MA 5723-18	MA 5724-18

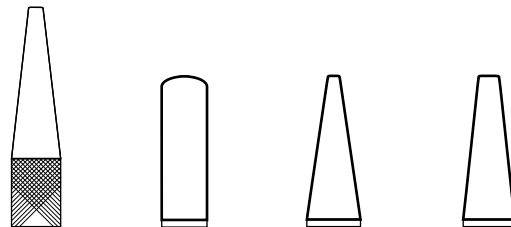

Typ / Type	18,5 cm – 7¼"	17,5 cm – 7"		
TC	MA 5761-17	MA 5761-18	MA 5761-19	MA 5761-20

Drahtspannzangen Wire Twisting Forceps



13 cm – 5" | **MA 5761-41**
18 cm – 7" | **MA 5761-42**

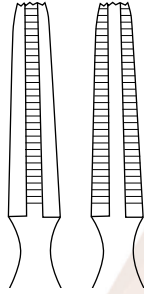

Körnung 0,5 mm
Grit 2500 tpsi



Typ / Type	18 cm – 7"
TC	MA 5761-08



Typ / Type	20 cm – 8"
TC	MA 5761-09



Körnung 0,5 mm
Grit 2500 tpsi

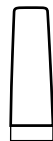

Typ / Type	15 cm – 6"	20 cm – 8"	15 cm – 6"
TC	MA 5761-10	MA 5761-11	MA 5761-12

M.ASHRAF
INSTRUMENTS

Drahtfasszangen Wire Holding Forceps



Typ / Type	17 cm – 6¾"
TC	MA 5761-15

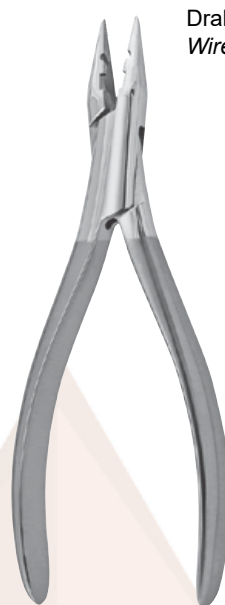

Drahtschneide- und Biegezange
Wire cutting and bending pliers

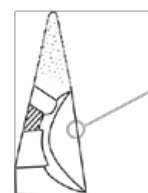

Schne / Cutting
weich / soft
1.5 mm

hart / hard	1.0 mm
-------------	--------

16 cm – 6¼"
MA 5759-16

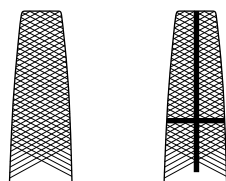

17 cm – 6¾"

MA 5761-31	MA 5761-32
------------	------------

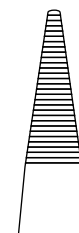

19 cm – 7½"

MA 5761-33

Flachzangen
Flat Nose Pliers



rostfreier Stahl
stainless steel



18,5 cm – 7¼"

MA 5764-00



rostfreier Stahl
stainless steel



18 cm – 7"

MA 5764-51



18 cm – 7"

MA 5764-60

M.ASHRAF
INSTRUMENTS

Drahtschneidezangen Wire Cutting Pliers

für weichen Knochen Draht bis Ø
für harte Bohrdrähte/Knochennägel bis Ø
for soft bone wire with a max. diameter of
for hard drill wires/bone nails with a max. diameter of

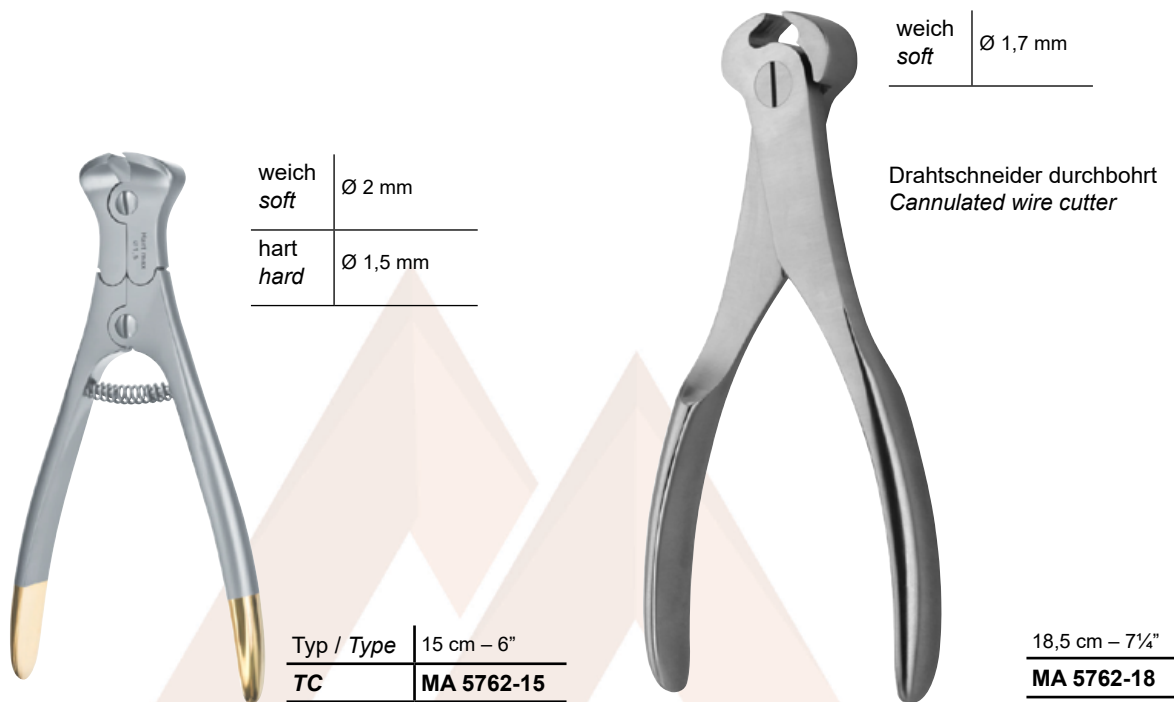

Drahtschneidezangen Wire Cutting Pliers

für weichen Knochenraht bis Ø
für harte Bohrdrähte/Knochennägel bis Ø
for soft bone wire with a max. diameter of
for hard drill wires/bone nails with a max. diameter of



hart hard	Ø 0,6 mm
--------------	----------



Typ / Type	12 cm – 4¾"
TC	MA 5766-12

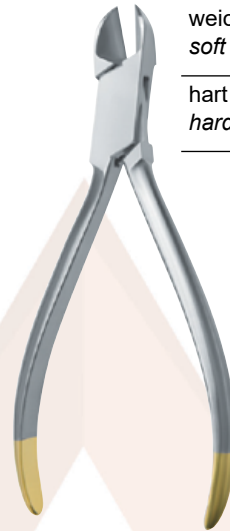

weich soft	Ø 1,5 mm
hart hard	Ø 1 mm



Typ / Type	15 cm – 6"
TC	MA 5766-24



weich soft	Ø 2 mm
hart hard	Ø 1,7 mm

Typ / Type	18 cm – 7"
TC	MA 5767-18



weich soft	Ø 3 mm
hart hard	Ø 2,5 mm

Typ / Type	22 cm – 8¾"
TC	MA 5767-22

MODELL RUDOLF
RUDOLF PATTERN

Drahtschneidezangen Wire Cutting Pliers

für weichen Knochen Draht bis Ø
für harte Bohrdrähte/Knochen Nägel bis Ø
for soft bone wire with a max. diameter of
for hard drill wires/bone nails with a max. diameter of



weich soft	Ø 2,5 mm
hart hard	Ø 1,5 mm

Typ / Type	18,5 cm – 7¼"
TC	MA 5768-18

MODELL RUDOLF
RUDOLF PATTERN



Bolzenschneider zum Abwickeln
von Drähten, Schrauben und
Nägeln bis zu Ø 6 mm
Cutter for cutting off wires,
bolts and pins up to Ø 6 mm



1:3



1:3

47 cm – 18½"	MA 5767-47
54 cm – 21¼"	MA 5767-57

1:4



Typ / Type	18 cm – 7"
TC	MA 5769-18
weichsoft	Ø 2 mm
harthard	Ø 1,7 mm

Typ / Type	22 cm – 8¾"
TC	MA 5769-22
weichsoft	Ø 3 mm
harthard	Ø 2,5 mm



hart hard	Ø 2,2 mm
--------------	----------

Typ / Type	23,5 cm – 9¼"
TC	MA 5769-32

1:3

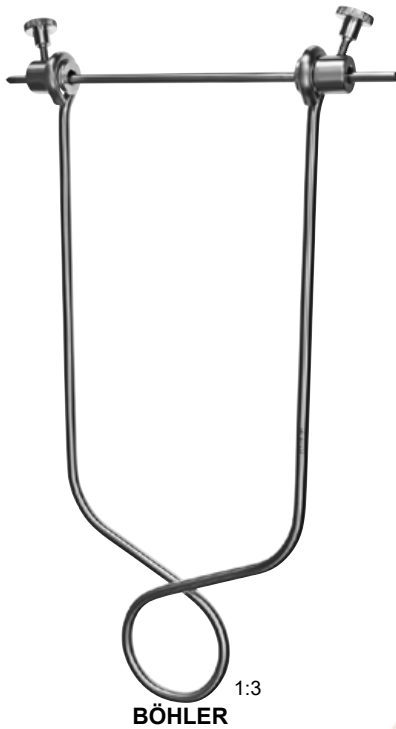

mit 1 Nagel
with 1 pin

für Arm
for arm

16 x 9 cm – 6¼" x 3½"	MA 5770-16
-----------------------	-------------------

für Oberschenkel und Knie
for thigh and knee

21 x 11 cm – 8¼" x 4¼"	MA 5770-21
------------------------	-------------------



lichte Weite
clear width

18 x 10 cm – 7" x 4"	MA 5773-18
27 x 16 cm – 10½" x 6¼"	MA 5773-27

Cerclage-Instrumente Cerclage Instruments

Knochendraht in
Ringen zu 10 m

*Bone wire
coil of 10 m*



Ø mm	weichsoft
0,2	MA 5778-02
0,3	MA 5778-03
0,4	MA 5778-04
0,5	MA 5778-05
0,6	MA 5778-06
0,7	MA 5778-07
0,8	MA 5778-08
0,9	MA 5778-09
1,0	MA 5778-10
1,2	MA 5778-12
1,5	MA 5778-15

Drahtspanninstrument
Bone wire tighteners



21 cm – 8¼"
MA 5782-00

LOUTE

Drahtumführungs
nadeln
Bone wire guides



1:3

30,5 cm – 12"	Fig. 1	MA 5780-01
28,5 cm – 11¼"	Fig. 2	MA 5780-02
27,5 cm – 10¾"	Fig. 3	MA 5780-03

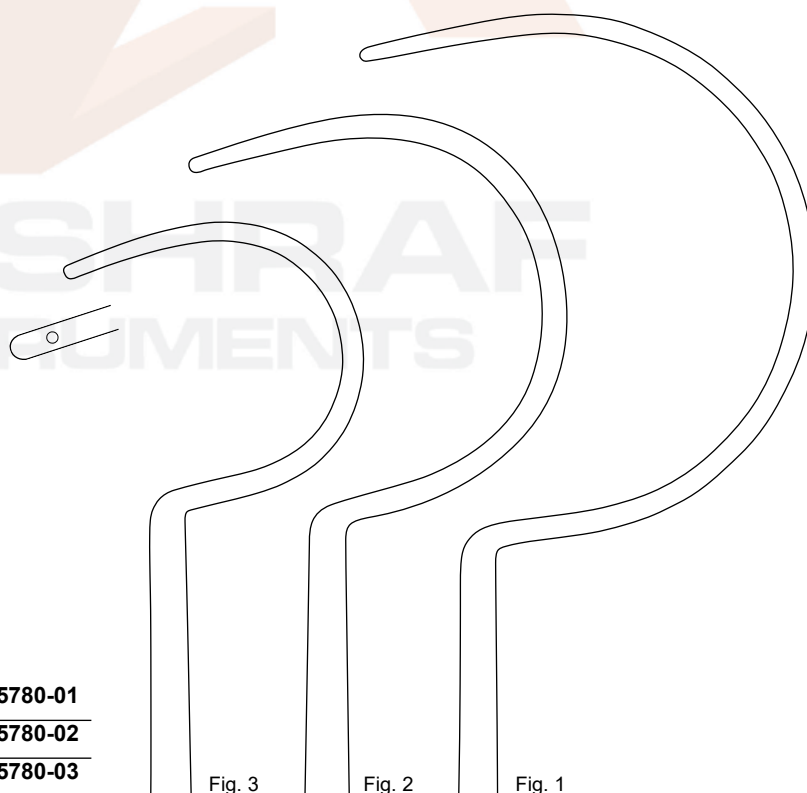

Fig. 3

Fig. 2

Fig. 1

Hämmer Mallets



Ø 25 mm
160 g

mit auswech selbarer
Kunststoffbacke
*with interchangeable
plastic disk*

1 Ersatzbacke
1 Spare disk

MA 5797-51

18,5 cm – 7¼"

MA 5797-17



Ø 30 mm
230 g

mit auswech selbaren
Kunststoffbacken
*with interchangeable
plastic disks*

Ersatzbackenpaar
Pair of spare disks

MA 5798-51

24 cm – 9½"

MA 5798-24

1:3



Ø 25 mm
135 g

mit auswech selbaren
Kunststoffbacken
*with interchangeable
plastic disks*

Ersatzbackenpaar
Pair of spare disks

MA 5799-51

19 cm – 7½"

MA 5799-18



Ø 30 mm
300 g

23,5 cm – 9¼"

MA 5800-23

1:3
BERGMANN

Hämmer Mallets



Ø 14 / 24 mm
420 g

Kopf massiv, aus
Implant-Werkstoff
*Head massive, made
of implantat material*

23,5 cm – 9¼"

MA 5801-23

1:3



Ø 45 mm
380 g

24 cm – 9½"

MA 5802-24

1:3

BERGMANN



Ø 30 mm
180 g

24 cm – 9½"

MA 5803-10

Ø 40 mm
350 g

24 cm – 9½"

MA 5803-35

Ø 45 mm
500 g

24 cm – 9½"

MA 5803-50

Ø 50 mm
700 g

24 cm – 9½"

MA 5803-70



Ø 30 / 42 mm
400 g

24 cm – 9½"

MA 5804-24

Hämmer Mallets



Ø 40 mm
700 g

18 cm – 7"

MA 5805-18



Ø 40 mm
550 g

24 cm – 9½"

MA 5806-24

1:3
OMBREDANNE



Ø 30 mm
480 g

23,5 cm – 9¼"

MA 5807-00/00 komplett mit:
MA 5807-00/01
MA 5807-00/02
MA 5807-00/03

MA 5807-00/00 complete with
MA 5807-00/01
MA 5807-00/02
MA 5807-00/03



Ø 30 mm
220 g

Metallbackenpaar
Pair of metal faces

MA 5807-00/01

Backen 1x konvex / 1x flach
faces 1x convex / 1x flat

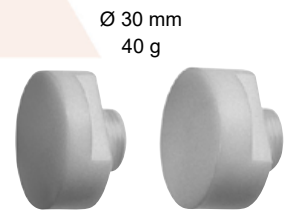

Ø 30 mm
40 g

Kunststoffbackenpaar
Pair of synthetic faces

MA 5807-00/02

Backen 1x konvex / 1x flach
faces 1x convex / 1x flat



Schlüssel
Wrench

MA 5807-00/03

Hämmer Mallets



Ø 35 mm
100 g

26 cm – 10¼"

MA 5808-01

Ø 43 mm
170 g

26 cm – 10¼"

MA 5808-02

Ø 50 mm
220 g

26 cm – 10¼"

MA 5808-03

1:3



Ø 30 mm
380 g

mit Kunststoffstiel
with plastic handle

24 cm – 9½"

MA 5808-24

1:3



170 g

170 g

bleigefüllt
lead filled

23 cm – 9"

MA 5810-23



Ø 22 mm
170 g

Ø 22 mm
170 g

bleigefüllt
lead filled

19 cm – 7¾"

MA 5812-19



Ø 22 mm
135 g

Ersatzbackenpaar
Pair of spare disks

MA 5819-20

19,5 cm – 9½"

MA 5819-19

Hämmer Mallets



Ø 25 mm
220 g

19 cm – 7½"

MA 5820-19

GERZOG

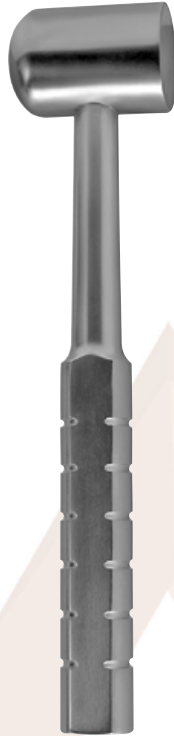

Ø 30 mm
240 g

konvex / flach
convex / flat

19 cm – 7½"

MA 5809-19

COTTLE



Ø 27 mm
145 g

20 cm – 8"

MA 5811-23

HAJEK

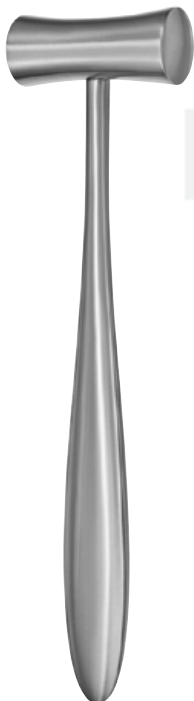

Ø 19 mm
80 g

19 cm – 7½"

MA 5813-01

LUCAE

Ø 25 mm
250 g

19 cm – 7½"

MA 5813-02



Ø 20 mm
100 g

bleigefüllt
lead filled

16,5 cm – 6½"

MA 5814-16

Ø 20 mm
75 g

Messing
Brass

16,5 cm – 6½"

MA 5815-16

M.ASHRAF
INSTRUMENTS

Hämmer Mallets



MEAD

Ø 26 mm
170 g

mit auswech selbaren
Kunststoffbacken
*with interchangeable
plastic disks*

Ersatzbackenpaar
Pair of spare disks

MA 5816-20

19 cm – 7½"

MA 5816-17



PARTSCH

Ø 22 mm
115 g

bleigefüllt
lead filled

18 cm – 7"

MA 5819-18

M.ASHRAF
INSTRUMENTS



Sehnedurchziehzange
Tendon passing forceps

KLEINERT-KUTZ



leicht gebogen
slightly curved

20 cm – 8"

MA 5827-35



Sehnenfasszange
Tendon seizing forceps

BRAND

M.ASHRAF
INSTRUMENTS



gerade
straight

gebogen
curved

15 cm – 6"	MA 3160-15	MA 3161-15
19 cm – 7½"	MA 3160-19	MA 3161-19
24 cm – 9½"	MA 3160-24	MA 3161-24

Sehneninstrumente Tendon Instruments



Sehnenhaltezange
Tendon grasping forceps

11,5 cm – 4½"
MA 5827-15

STEINMANN



Sehnenfasszange
Tendon seizing forceps

11 cm – 4¼"
MA 5827-18

CAROLL

M.ASHRAF
INSTRUMENTS



Sehnenfl echtklemme
Tendon plating forceps



gerade
straight

gebogen
curved

15 cm – 6"

MA 5827-20

MA 5827-21



Sehnnenscheidenhaken
Tendon sheath hooks

6 x 16 mm



6 x 16 mm



gezahnt
toothed

19 cm – 7½"

MA 4482-01

MA 4482-02

STRANDELL-STILLE



Sehnnenscheidenhaken
Tendon sheath hooks

12 x 6 mm



stumpf
blunt

17,5 cm – 7"

MA 4483-01

KLAPP



1:4

Bleihand für
Kinder
*Lead hand for
children*

MA 5822-01

Bleihand für
Erwachsene
*Lead hand
for adults*

MA 5822-02



M.ASHRAF
INSTRUMENTS



ELEVEN



M.ASHRAF
INSTRUMENTS

HF-Handgriffe	<i>HF-Handles</i>	HF 1 - 2
Monopolare Elektroden	<i>Monopolar Electrodes</i>	HF 3 - 4
Bipolare Scheren	<i>Bipolar Scissors</i>	HF 5 - 6
Bipolare Pinzetten	<i>Bipolar Forceps</i>	HF 7 - 17
Bipolare Anschlusskabel	<i>Bipolar Connecting Cables</i>	HF 18

HF-Handgriffe HF-Handles

zur Verwendung mit Elektroden Ø 2,4 mm und 6-kant Schaft
to be used with electrodes Ø 2.4 mm and 6-edge shaft



max. Spannung: 4,3 kVp
~~max. voltage: 4.3 kVp~~

Anschluss Geräteseite
Connection equipment side



HF-Handgriff evoline

für Erbe ACC / ICC, Storz-Geräte

HF-Handle evoline

for Erbe ACC / ICC, Storz devices

mit integriertem Kabel *with integrated cable*
mit 2 Tasten *with 2 buttons*

Länge / Length
4 m

HF410-026

max. Spannung: 4,3 kVp
~~max. voltage: 4.3 kVp~~

Anschluss Geräteseite
Connection equipment side



HF-Handgriff evoline

für Berchtold / Martin / Aesculap / INTEGRA-Geräte

HF-Handle evoline

for Berchtold / Martin / Aesculap / INTEGRA devices

mit integriertem Kabel *with integrated cable*
mit 2 Tasten *with 2 buttons*

Länge / Length
4 m

HF410-028

max. Spannung: 4,3 kVp
max. voltage: 4.3 kVp

Anschluss Geräteseite
Connection equipment side



HF-Handgriff evoline

für Modelle mit internationalem Anschluss 3-polig

HF-Handle evoline

for models with international connection plug 3 pin

mit integriertem Kabel *with integrated cable*
mit 2 Tasten *with 2 buttons*

Länge / Length
4 m

HF410-030

HF-Handgriffe HF-Handles

zur Verwendung mit Elektroden Ø 4 mm und 6-kant Schaft
be used with electrodes Ø 4 mm and 6-edge shaft



max. Spannung: 4,3 kVp
~~max. voltage: 4.3 kVp~~

Anschluss Geräteseite
Connection equipment side



HF-Handgriff evoline

für Erbe ACC / ICC, Storz-Geräte

HF-Handle evoline

for Erbe ACC / ICC, Storz devices

mit integriertem Kabel with integrated cable mit 2 Tasten with 2 buttons	Länge / Length 4 m	HF410-020
---	-----------------------	------------------

max. Spannung: 4,3 kVp
~~max. voltage: 4.3 kVp~~

Anschluss Geräteseite
Connection equipment side



HF-Handgriff evoline

für Berchtold / Martin / Aesculap / INTEGRA-Geräte

HF-Handle evoline

for Berchtold / Martin / Aesculap / INTEGRA devices

mit integriertem Kabel with integrated cable mit 2 Tasten with 2 buttons	Länge / Length 3 m	HF410-022
---	-----------------------	------------------

max. Spannung: 4,3 kVp
~~max. voltage: 4.3 kVp~~

Anschluss Geräteseite
Connection equipment side



HF-Handgriff evoline

für Modelle mit internationalem Anschluss 3-polig

HF-Handle evoline



for models with international connection plug 3 pin



mit integriertem Kabel with integrated cable mit 2 Tasten with 2 buttons	Länge / Length 3 m	HF410-024
---	-----------------------	------------------

Monopolare Elektroden Monopolar Electrodes







6-kant Schaft
6-edge shaft



Modell Model	Beschreibung Description	Abmessungen Dimensions	2,4 mm Schaft 2.4 mm shaft
	Lanzetten-Elektrode <i>Lancet electrode</i>	20 mm x 2,5 mm	MA 0470-51
	Messer-Elektrode <i>Knife electrode</i>	20 mm x 2,5 mm	MA 0470-54
	Nadel-Elektrode <i>Needle electrode</i>	18 mm x Ø 0,7 mm	MA 0470-60

Modell Model	Beschreibung Description	Abmessungen Dimensions	2,4 mm Schaft 2.4 mm shaft
		Ø 2 mm	MA 0470-65
	Kugel-Elektrode <i>Ball electrode</i>	Ø 4 mm	MA 0470-67
		Ø 6 mm	MA 0470-69

Monopolare Elektroden Monopolar Electrodes

6-kant Schaft
6-edge shaft

Modell Model	Beschreibung Description	Abmessungen Dimensions	4 mm Schaft 4 mm shaft
	Lanzetten-Elektrode Lancet electrode	19 mm x 1,6 mm	MA 0470-01
	Lanzetten-Elektrode Lancet electrode	19 mm x 1,6 mm	MA 0470-02
	Messer-Elektrode Knife electrode	25 mm x 3,3 mm	MA 0470-04
	Nadel-Elektrode Needle electrode	22 mm x Ø 0,8mm	MA 0470-10

Modell Model	Beschreibung Description	Abmessungen Dimensions	4 mm Schaft 4 mm shaft
	Kugel-Elektrode Ball electrode	Ø 2 mm	MA 0470-15
		Ø 4 mm	MA 0470-17
		Ø 6 mm	MA 0470-19

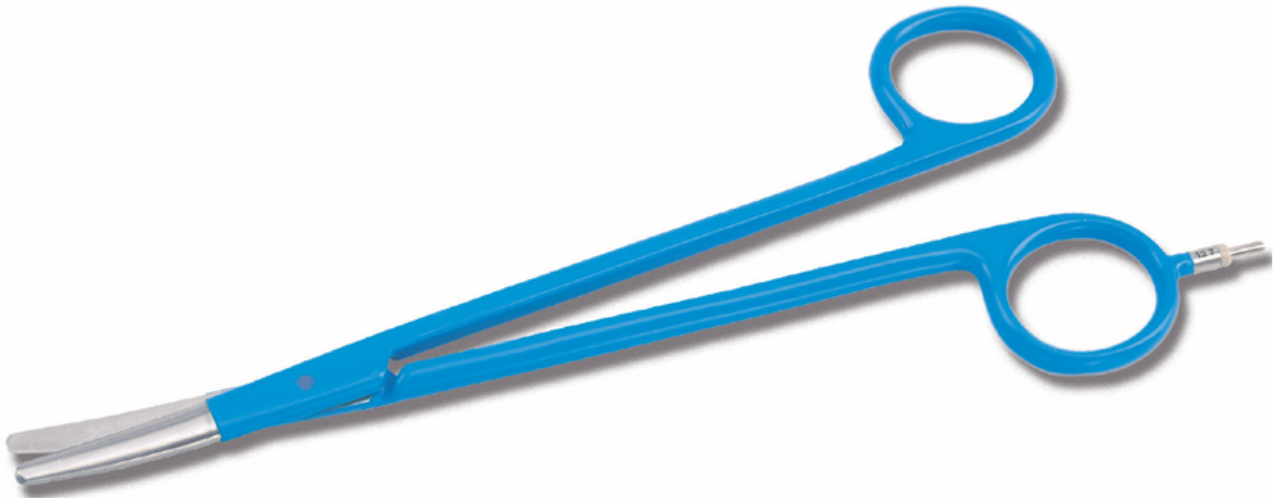

Allgemein

Merkmale unserer bipolaren Scheren:

- Die Stromzufuhr erfolgt über eine Steckverbindung an nur einem Griff der Schere, die Handhabung während des OP's wird dadurch extrem erleichtert.
- RUDOLF Bipolare Scheren ermöglichen das Schneiden und Präparieren bei gleichzeitiger Koagulation.
- Unterschiedliche Arbeitslängen und zwei Versionen (Standard und schlank) erlauben den Einsatz für eine Vielzahl von Anwendungen.
- Die spezielle Konstruktion macht sie besonders reparaturfreundlich.
- Die Scherenschrauben dienen der Stromführung von einem auf das andere Scherenblatt, die Scherenblätter mit Voll-Keramik-Einlage können voneinander getrennt und nachgeschärft werden.

General information

Features of our bipolar scissors:

- *The power is supplied by means of a plug-in construction to one ring only. This simplifies handling during the operation considerably.*
- *RUDOLF bipolar scissors enable cutting and dissection with simultaneous bipolar coagulation.*
- *Various working length and two versions (standard and slim) allow the scissors to be used for a large number of applications.*
- *The special construction ensures that the scissors are easy to repair.*
- *The screws conduct the current from one blade to the other, the blades with a solid ceramic insert can be separated for re-sharpening.*

M.ASHRAF
INSTRUMENTS

Bipolare Scheren Bipolar Scissors

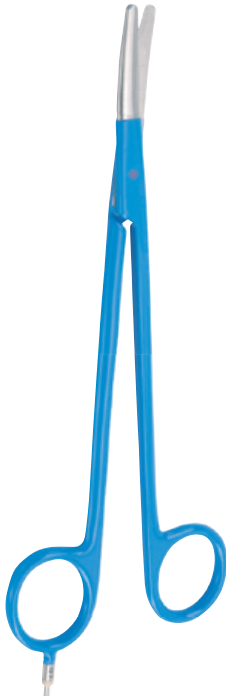







METZENBAUM



Länge Length	gebogen Standard- curved Standard	gebogen schlank- curved slim
18 cm – 7"	MA 1381-18	MA 1382-18
21 cm – 8¼"	MA 1381-21	MA 1382-21
23 cm – 9"	MA 1381-23	MA 1382-23
28 cm – 11"	MA 1381-28	MA 1382-28

Bipolare Anschlusskabel für abgebildete Scheren
Bipolar connecting cables for illustrated scissors

Gerätestecker Plug, generator side	Instrumentenstecker Plug, instrument side	Länge Length	
 Erbe ACC / ICC, Storz		3 m	HF300-202
		5 m	HF300-203
 Martin, Berchtold, Aesculap		3 m	HF300-204
		5 m	HF300-205
 Valleylab, Lamidey, EMC		3 m	HF300-206
		5 m	HF300-207

Bipolare Pinzetten

Bipolar Forceps



Allgemein

Merkmale unserer bipolaren Pinzetten:

- Lieferbar mit Flachstecker, auf Anfrage auch mit 2-Pin-Stecker (US-Standard).
- Präzise schließende Arbeitsenden gewährleisten ein sicheres und schonendes Arbeiten. ■ Die schlanke und feine Formgebung garantieren ein sicheres Arbeiten auch in besonders delikaten Einsatzbereichen bzw. an schwer zugänglichen Stellen.
- Die breite, geriefte Grifffläche ermöglicht eine sichere Handhabung.
- Die bewährte und äußerst beständige Isolationsbeschichtung gewährleistet die Sicherheit des Instrumentes.
- Unser Kunststoff-Sicherheitsstecker garantiert eine glatte Steckverbindung und damit sicheren elektrischen Kontakt.

NON-STICK Pinzetten:

NON-STICK Pinzetten verhindern das Verkleben des koagulierten Gewebes mit der Pinzetten-spitze. Dafür sorgen spezielle polierte Edelmetallspitzen mit einer exzellenten Wärmeleitfähigkeit. Diese Antihafteigenschaften bleiben auch nach einem evtl. Nachpolieren erhalten, da die gesamten Pinzetten-spitzen aus Edelmetall hergestellt sind und es sich nicht nur um eine Beschichtung handelt.

General information

Features of our bipolar forceps:

- Available with flat plug, on demand also with 2-pin-plug (US-Standard).
- The precise closing of the jaws ensures safe and gentle working.
- The slim and delicate design grants safe working in extremely delicate areas or in hard-to-reach places.
- The broad, rifeled surface of the handle ensures safe handling.
- The well proven and extremely durable isolation coating grants the safeness of the instrument.
- Our plastic-safety plug grants a smooth plugging and therefore a safe electric contact.

NON-STICK Forceps:

The NON-STICK forceps prevents the sticking of coagulated tissue on the forceps tips. This is possible due to specially polished tips made of precious metal having an excellent heat conductance. These anti-adhesion properties are not lost even after a possible re-polishing, due to the fact that the complete tip of the forceps is made of precious metal and it is not only a coating.

Bipolare Pinzetten

Bipolar Forceps



gerade
straight

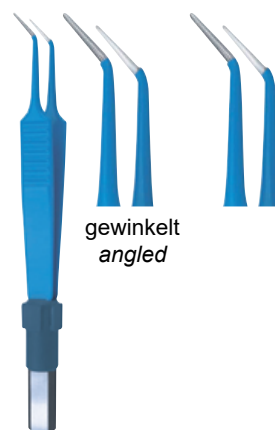

gewinkelt
angled



gebogen
curved

Anschluss Plug	Länge Length	Spitzenbreite Width of tips	Standard	NON-STICK	Standard	NON-STICK	Standard
	11 cm – 4¼"	0,25 mm	HF510-011	HF510-051	HF510-211	HF510-251	HF510-411
		0,60 mm	HF510-111	HF510-151	HF510-311	HF510-351	HF510-511
		1,00 mm	–	HF510-152	–	HF510-352	–



kniegebogen
curved shanks

Anschluss Plug	Länge Length	Spitzenbreite Width of tips	Standard
	17 cm – 6¾"	0,30 mm	HF518-017
		1,00 mm	HF518-117

Passende Bipolare Anschlusskabel auf Seite HF 18.

Suitable bipolar connecting cables on page HF 18.

Bipolare Pinzetten

Bipolar Forceps

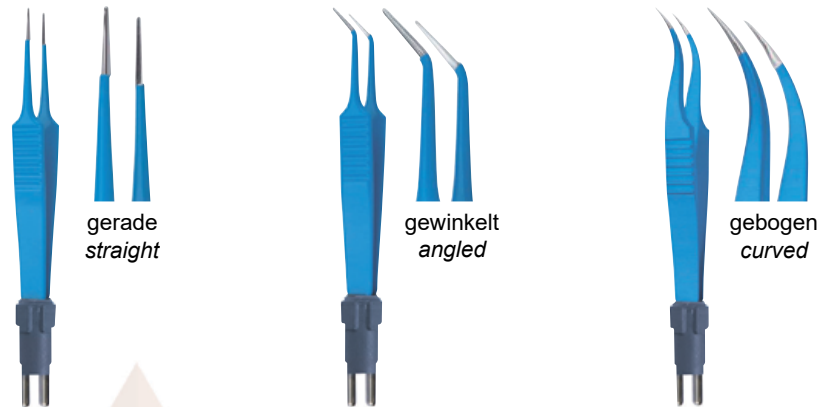

Anschluss Plug	Länge Length	Spitzenbreite Width of tips	Standard	NON-STICK	Standard	NON-STICK	Standard
	12 cm – 4¾"	0,25 mm	HF511-011	HF511-051	HF511-211	HF511-251	HF511-411
		0,80 mm	HF511-111	HF511-151	HF511-311	HF511-351	HF511-511
		1,00 mm	–	HF511-152	–	HF511-352	–

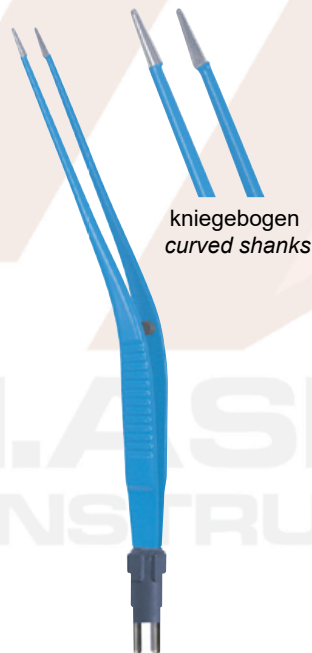

Anschluss Plug	Länge Length	Spitzenbreite Width of tips	Standard
	17 cm – 6¾"	0,30 mm	HF519-017
		1,00 mm	HF519-117

2-Pin-Stecker (US-Standard).
Passende Bipolare Anschlusskabel auf Seite HF 18.

2-pin-plug (US-Standard).
Suitable bipolar connecting cables on page HF 18.

Bipolare Pinzetten

Bipolar Forceps



Anschluss Plug	Länge Length	Spitzenbreite Width of tips	Standard	NON-STICK	Standard	NON-STICK
	15 cm – 6"	0,30 mm	HF515-015	HF515-055	HF515-515	HF515-555
		0,60 mm	–	HF515-056	–	–
		1,00 mm	HF515-115	HF515-155	HF515-615	HF515-655
		2,00 mm	–	HF515-156	–	HF515-656
	18 cm – 7"	0,30 mm	HF515-018	HF515-058	HF515-518	HF515-558
		0,60 mm	–	HF515-059	–	–
		1,00 mm	HF515-118	HF515-158	HF515-618	HF515-658
		2,00 mm	–	HF515-159	–	HF515-659
	20 cm – 8"	0,30 mm	HF515-020	HF515-070	HF515-520	–
		1,00 mm	HF515-120	HF515-170	HF515-620	–
		2,00 mm	–	HF515-171	–	–
	22 cm – 8¾"	0,30 mm	HF515-022	HF515-072	HF515-522	–
1,00 mm		HF515-122	HF515-172	HF515-622	–	
2,00 mm		–	HF515-173	–	–	
24 cm – 9½"	0,30 mm	HF515-024	–	HF515-524	–	
	1,00 mm	HF515-124	–	HF515-624	–	

Passende Bipolare Anschlusskabel auf Seite HF 18.

Suitable bipolar connecting cables on page HF 18.

Bipolare Pinzetten

Bipolar Forceps

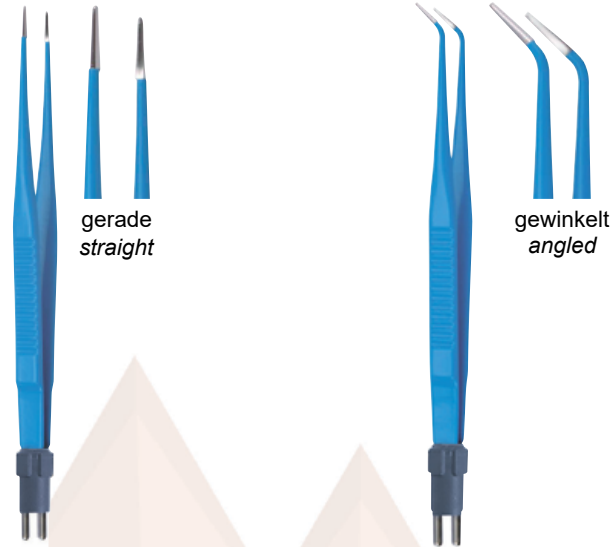

Anschluss Plug	Länge Length	Spitzenbreite Width of tips	Standard	NON-STICK	Standard	NON-STICK
	15 cm – 6"	0,30 mm	HF516-015	HF516-055	HF516-515	HF516-555
		0,60 mm	–	HF516-056	–	–
		1,00 mm	HF516-115	HF516-155	HF516-615	HF516-655
		2,00 mm	–	HF516-156	–	HF516-656
	18 cm – 7"	0,30 mm	HF516-018	HF516-058	HF516-518	HF516-558
		0,60 mm	–	HF516-059	–	–
		1,00 mm	HF516-118	HF516-158	HF516-618	HF516-658
		2,00 mm	–	HF516-159	–	HF516-659
	20 cm – 8"	0,30 mm	HF516-020	HF516-070	HF516-520	–
		1,00 mm	HF516-120	HF516-170	HF516-620	–
		2,00 mm	–	HF516-171	–	–
	22 cm – 8¾"	0,30 mm	HF516-022	HF516-072	HF516-522	–
1,00 mm		HF516-122	HF516-172	HF516-622	–	
2,00 mm		–	HF516-173	–	–	
24 cm – 9½"	0,30 mm	HF516-024	–	HF516-524	–	
	1,00 mm	HF516-124	–	HF516-624	–	

2-Pin-Stecker (US-Standard).
Passende Bipolare Anschlusskabel auf Seite HF 18.

2-pin-plug (US-Standard).
Suitable bipolar connecting cables on page HF 18.

Bipolare Pinzetten

Bipolar Forceps

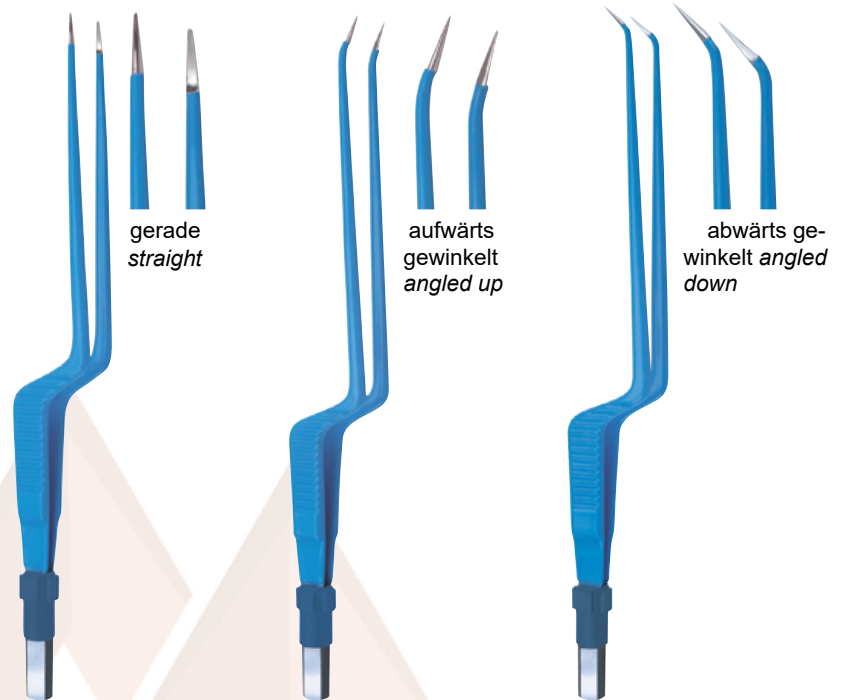

Anschluss Plug	Länge Length	Spitzenbreite Width of tips	Standard	NON-STICK	Standard	NON-STICK	Standard	NON-STICK
	16,5 cm – 6½"	0,60 mm	HF520-017	–	–	–	–	–
	18 cm – 7"	0,30 mm	HF520-018	HF520-058	HF520-418	–	HF520-818	–
		0,60 mm	–	HF520-059	–	–	–	–
		1,00 mm	HF520-118	HF520-158	HF520-518	–	HF520-918	–
		2,00 mm	–	HF520-159	–	–	–	–
	20 cm – 8"	0,30 mm	HF520-020	HF520-070	HF520-420	–	HF520-820	–
		0,60 mm	–	HF520-071	–	–	–	–
		1,00 mm	HF520-120	HF520-170	HF520-520	HF520-570	HF520-920	HF520-970
		2,00 mm	–	HF520-171	–	–	–	–
	22 cm – 8¾"	0,30 mm	HF520-022	HF520-072	HF520-422	–	HF520-822	–
		0,60 mm	–	HF520-073	–	–	–	–
		1,00 mm	HF520-122	HF520-172	HF520-522	HF520-572	HF520-922	HF520-972
		2,00 mm	–	HF520-173	–	–	–	–
	24 cm – 9½"	0,30 mm	HF520-024	HF520-074	HF520-424	–	HF520-824	–
		0,60 mm	–	HF520-075	–	–	–	–
		1,00 mm	HF520-124	HF520-174	HF520-524	–	HF520-924	–
		2,00 mm	–	HF520-175	–	–	–	–

Passende Bipolare Anschlusskabel auf Seite HF 18.

Suitable bipolar connecting cables on page HF 18.

Bipolare Pinzetten

Bipolar Forceps

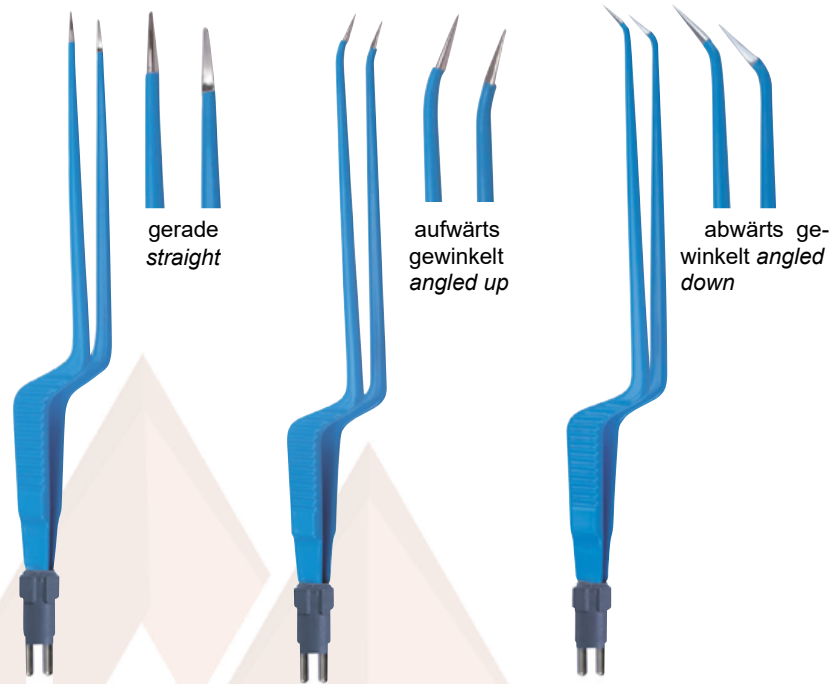

Anschluss Plug	Länge Length	Spitzenbreite Width of tips	Standard		NON-STICK		Standard		NON-STICK	
			Standard	NON-STICK	Standard	NON-STICK	Standard	NON-STICK		
	18 cm – 7"	0,30 mm	HF521-018	HF521-058	HF521-418	–	HF521-818	–	–	–
		0,60 mm	–	HF521-059	–	–	–	–	–	–
		1,00 mm	HF521-118	HF521-158	HF521-518	–	HF521-918	–	–	–
		2,00 mm	–	HF521-159	–	–	–	–	–	–
	20 cm – 8"	0,30 mm	HF521-020	HF521-070	HF521-420	–	HF521-820	–	–	–
		0,60 mm	–	HF521-071	–	–	–	–	–	–
		1,00 mm	HF521-120	HF521-170	HF521-520	HF521-570	HF521-920	HF521-970	–	–
		2,00 mm	–	HF521-171	–	–	–	–	–	–
	22 cm – 8¾"	0,30 mm	HF521-022	HF521-072	HF521-422	–	HF521-822	–	–	–
		0,60 mm	–	HF521-073	–	–	–	–	–	–
		1,00 mm	HF521-122	HF521-172	HF521-522	HF521-572	HF521-922	HF521-972	–	–
		2,00 mm	–	HF521-173	–	–	–	–	–	–
	24 cm – 9½"	0,30 mm	HF521-024	HF521-074	HF521-424	–	HF521-824	–	–	–
		0,60 mm	–	HF521-075	–	–	–	–	–	–
		1,00 mm	HF521-124	HF521-174	HF521-524	–	HF521-924	–	–	–
		2,00 mm	–	HF521-175	–	–	–	–	–	–

2-Pin-Stecker (US-Standard).
Passende Bipolare Anschlusskabel auf Seite HF 18.

2-pin-plug (US-Standard).
Suitable bipolar connecting cables on page HF 18.

Bipolare Pinzetten

Bipolar Forceps

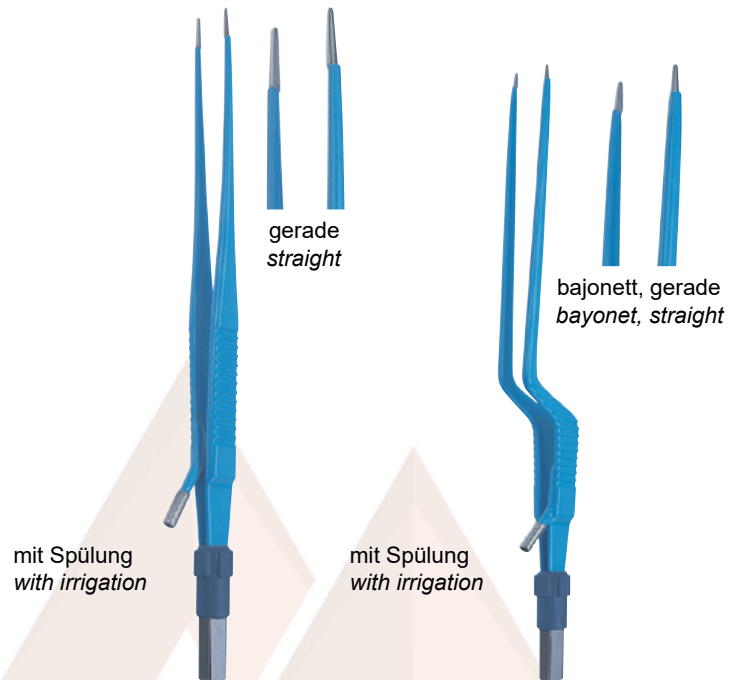



Anschluss Plug	Länge Length	Spitzenbreite Width of tips	Standard	Spitzenbreite Width of tips	Standard
	18cm – 7"	0,5 x 8 mm	HF530-018	0,5 x 8 mm	HF532-018
		1,0 x 8 mm	HF530-118	1,0 x 8 mm	HF532-118
		2,0 x 8 mm	HF530-218	1,5 x 8 mm	HF532-218
	20 cm – 8"	0,5 x 8 mm	HF530-020	0,5 x 8 mm	HF532-020
		1,0 x 8 mm	HF530-120	1,0 x 8 mm	HF532-120
		2,0 x 8 mm	HF530-220	1,5 x 8 mm	HF532-220
	22 cm – 8¾"	0,5 x 8 mm	HF530-022	0,5 x 8 mm	HF532-022
		1,0 x 8 mm	HF530-122	1,0 x 8 mm	HF532-122
		2,0 x 8 mm	HF530-222	1,5 x 8 mm	HF532-222
	24 cm – 9½"	–	–	0,5 x 8 mm	HF532-024
		–	–	1,0 x 8 mm	HF532-124
		–	–	1,5 x 8 mm	HF532-224

Passende Bipolare Anschlusskabel auf Seite HF 18.

Suitable bipolar connecting cables on page HF 18.

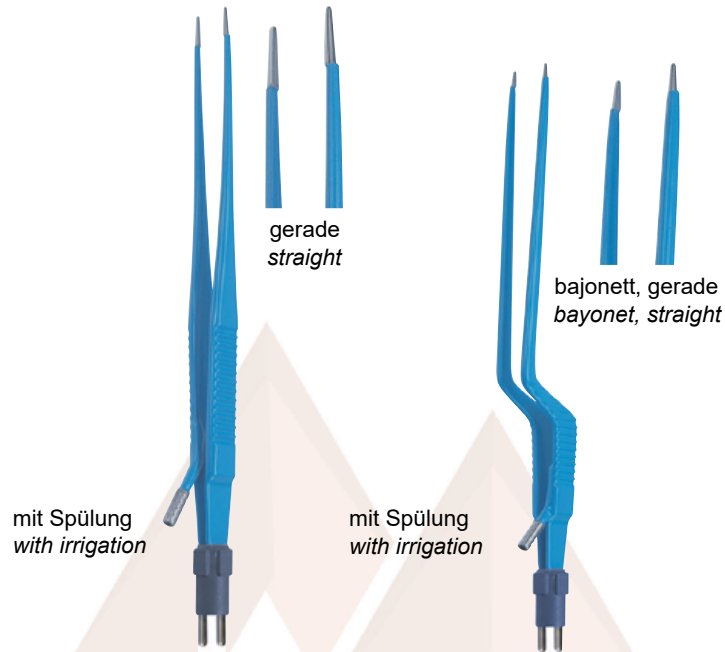
Bipolare Pinzetten Bipolar Forceps



Anschluss Plug	Länge Length	Spitzenbreite Width of tips	Standard	Spitzenbreite Width of tips	Standard
	18 cm – 7"	0,5 x 8 mm	HF531-018	0,5 x 8 mm	HF533-018
		1,0 x 8 mm	HF531-118	1,0 x 8 mm	HF533-118
		2,0 x 8 mm	HF531-218	1,5 x 8 mm	HF533-218
	20 cm – 8"	0,5 x 8 mm	HF531-020	0,5 x 8 mm	HF533-020
		1,0 x 8 mm	HF531-120	1,0 x 8 mm	HF533-120
		2,0 x 8 mm	HF531-220	1,5 x 8 mm	HF533-220
	22 cm – 8¾"	0,5 x 8 mm	HF531-022	0,5 x 8 mm	HF533-022
		1,0 x 8 mm	HF531-122	1,0 x 8 mm	HF533-122
		2,0 x 8 mm	HF531-222	1,5 x 8 mm	HF533-222
	24 cm – 9½"	–	–	0,5 x 8 mm	HF533-024
		–	–	1,0 x 8 mm	HF533-124
		–	–	1,5 x 8 mm	HF533-224

2-Pin-Stecker (US-Standard).
Passende Bipolare Anschlusskabel auf Seite HF 18.

2-pin-plug (US-Standard).
Suitable bipolar connecting cables on page HF 18.

Bipolare Pinzetten

Bipolar Forceps

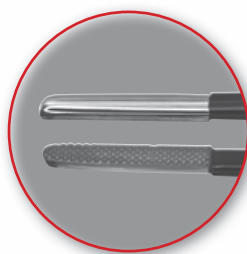

TC

Hartmetall
Tungsten Carbide

Allgemein

Merkmale unserer bipolaren Pinzetten, isoliert, mit TC-Einlage:

- Sicheres Fassen
- Praktisch kein Anhaften von Gewebe
- Sehr guter Gefäßverschluss

General information

Features of our bipolar forceps, insulated, with TC insert:

- Safe grasping
- Virtually no tissue sticking
- Excellent vessel closure



Anschluss Plug	Spitzenbreite Width of tips	16,5 cm – 6½"	22 cm – 8¾"	25 cm – 10"	30 cm – 11¾"
	2,2 mm	MA 4302-46	MA 4302-52	MA 4302-55	MA 4302-57

Passende Bipolare Anschlusskabel auf Seite HF 18.

Suitable bipolar connecting cables on page HF 18.

Bipolare Pinzetten

Bipolar Forceps

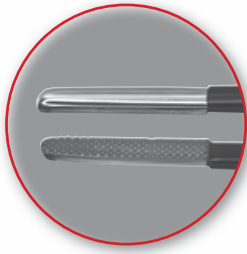

TC
Hartmetall
Tungsten Carbide

Allgemein

Merkmale unserer bipolaren Pinzetten, isoliert, mit **TC**-Einlage:

- Sicheres Fassen
- Praktisch kein Anhaften von Gewebe
- Sehr guter Gefäßverschluss

General information

Features of our bipolar forceps, insulated, with **TC** insert:

- Safe grasping
- Virtually no tissue sticking
- Excellent vessel closure



Anschluss Plug	Spitzenbreite Width of tips	19 cm – 7½"	19 cm – 7½"
	2,2 mm	MA 4302-76	MA 4302-82

Passende Bipolare Anschlusskabel auf Seite HF 18.

Suitable bipolar connecting cables on page HF 18.







Bipolare Anschlusskabel Bipolar Connecting Cables

für bipolare Pinzetten
for bipolar forceps

Flachstecker
Flat plug

2-Pin Stecker US-Standard
2-pin plug US-Standard



Gerätestecker Plug, generator side	Länge Length		Länge Length	
 Valleylab, Birtcher, Conmed, Bovie	3 m	HF310-103	4 m	HF310-3031
	5 m	HF310-105	-	-
 Erbe ACC / ICC, Storz	3 m	HF310-113	3 m	HF310-313
	5 m	HF310-115	5 m	HF310-315
 Martin, Berchtold, Aesculap	3 m	HF310-123	3 m	HF310-323
	5 m	HF310-125	5 m	HF310-325
 Valleylab, Lamidey, EMC	3 m	HF310-133	3 m	HF310-333
	5 m	HF310-135	5 m	HF310-335

TWELVE

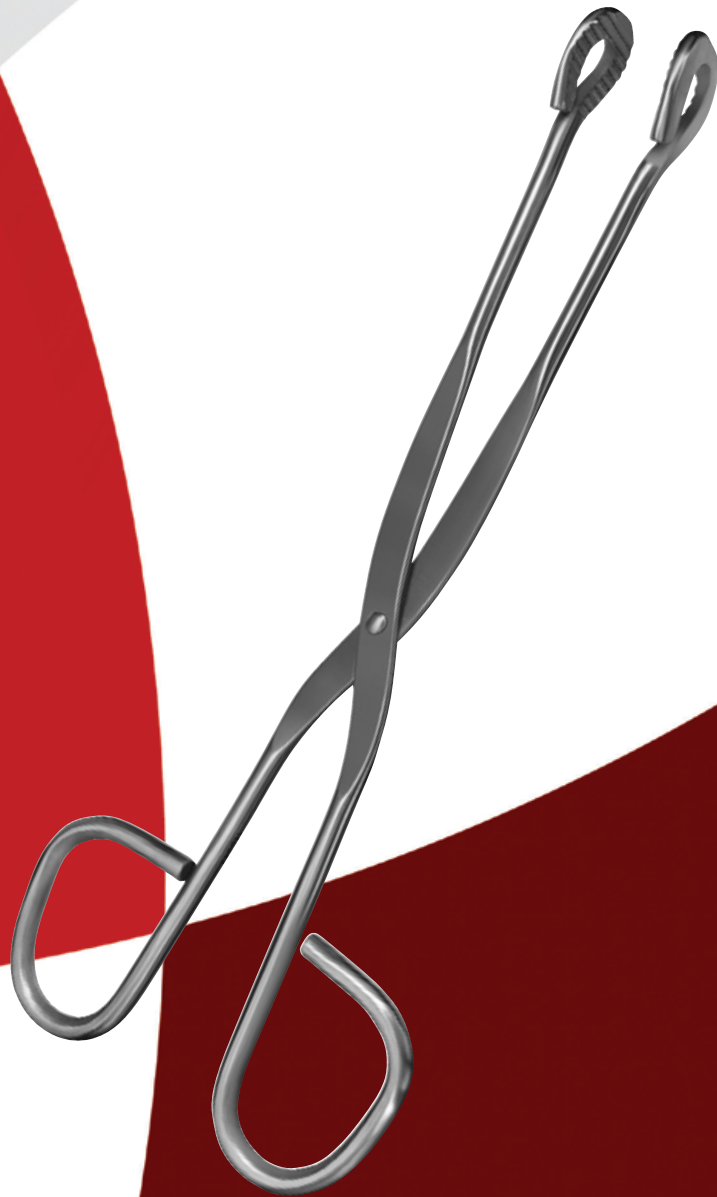

M.ASHRAF
INSTRUMENTS

Hygiene und Aufbewahrung

Hygiene and Storage

Sterilisierzangen	<i>Sterilization Forceps</i>	HS 1
Dreieckschalen und Stechbecken	<i>Triangular Bowls and Bed Pans</i>	HS 2
Messbecher und Nierenschalen	<i>Measuring Jugs and Kidney Bowls</i>	HS 3
Behälter, rund	<i>Bowls, Round</i>	HS 4 - 6
Instrumentenschalen	<i>Instrument Trays</i>	HS 7 - 8
Siebkörbe, Größe 1/2	<i>Baskets, Half Size</i>	HS 9
Siebkörbe, Größe 3/4	<i>Baskets, Three-Quarter Size</i>	HS 10
Siebkörbe, Größe 1/1	<i>Baskets, Full Size</i>	HS 11
Siebkörbe, Größe Mini	<i>Baskets, Mini Size</i>	HS 12 - 13
Zubehör	<i>Accessories</i>	HS 14 - 15
Bereitstellungstische, Regalwagen	<i>Trolleys</i>	HS 16 - 17

Sterilisierzangen Sterilization Forceps



Abfallzange
Waste forceps

55 cm – 21¼"
MA 8941-55

SAUERBRUCH

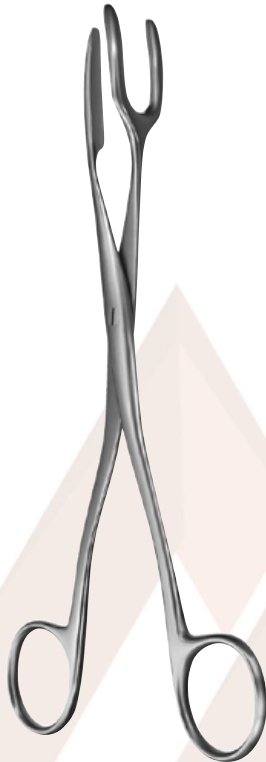

20 cm – 8"
MA 8945-20

30 cm – 11¾"
MA 8945-30



27 cm – 10½"
MA 8947-27

CHEATLE

Sterilisierklammern
Sterilization clamps



UNIVERSAL



20 cm – 8"
MA 8948-20



BUNT
10,5 cm – 4¼"
MA 8950-01

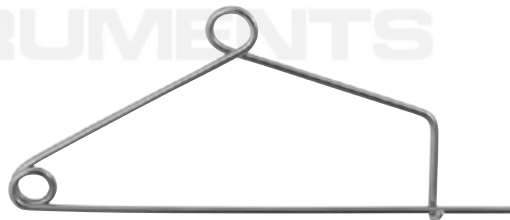

MAYO
14 cm – 5½"
MA 8950-02

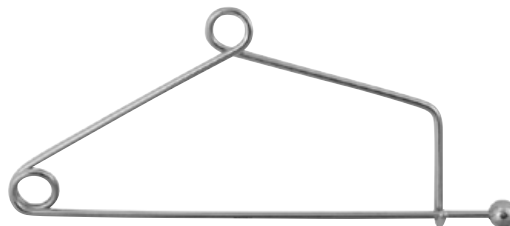

MAYO
14 cm – 5½"
MA 8950-03

Dreieckschalen und Stechbecken

Triangular Bowls and Bed Pans

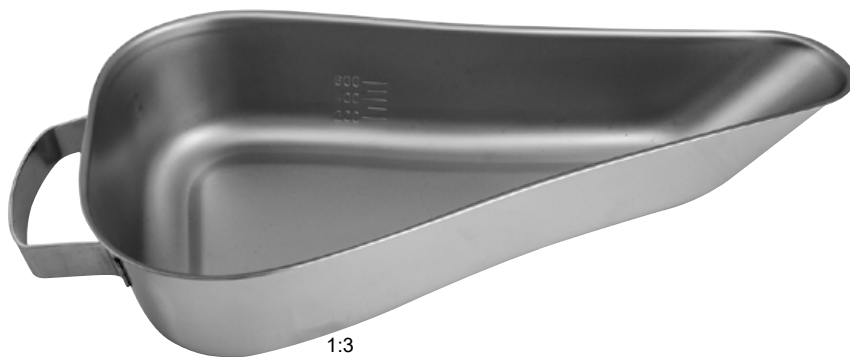

Dreieckschale mit Griff
Triangular bowl with handle

MA 8960-01



Dreieckschale
Triangular bowl

MA 8960-02

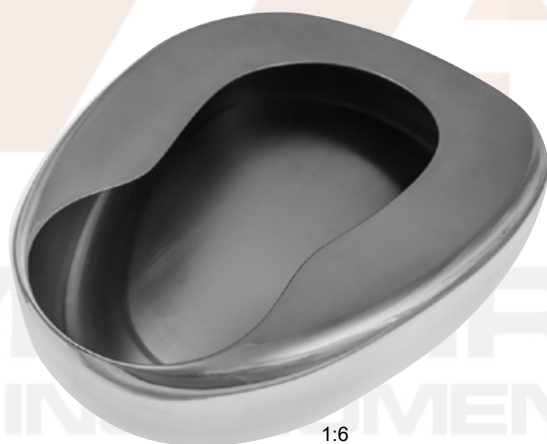

Stechbecken, amerikanische Form
Bed pan (American pattern)

350 x 290 x 90,5 mm

MA 8960-05



Stechbecken
Bed pan

230 x 70 mm	310 x 82 mm
-------------	-------------

MA 8961-01	MA 8961-02
-------------------	-------------------

Messbecher und Nierenschalen

Measuring Jugs and Kidney Bowls



	Messbecher <i>Measuring jugs</i>
0,25 l	MA 8964-02
0,50 l	MA 8964-05
1,00 l	MA 8964-10
1,50 l	MA 8964-15
2,00 l	MA 8964-20



		Nierenschalen <i>Kidney bowls</i>
0,25 l	170 x 36 mm	MA 8970-01
0,50 l	250 x 32 mm	MA 8970-02
0,75 l	275 x 45 mm	MA 8970-03

M.ASHRAF
INSTRUMENTS

Runde Behälter Round Bowls



	Wattespender <i>Cotton dispensers</i>
85 x 85 mm	MA 8972-01
100 x 100 mm	MA 8972-02
120 x 120 mm	MA 8972-03
150 x 150 mm	MA 8972-04



	Medizinbecher <i>Medicine cups</i>
25 cc	MA 8975-05
50 cc	MA 8975-10



	Medizinbecher <i>Medicine cups</i>
100 cc = 0,10 l	MA 8975-10/10
250 cc = 0,25 l	MA 8975-10/25



	Septumbecher <i>Septum cups</i>
85 x 85 mm	
	MA 8976-20

1:3

Runde Behälter Round Bowls



Ø x HØ x h	Standgefäße Jars
30 x 80 mm	MA 8984-01
35 x 100 mm	MA 8984-02
50 x 120 mm	MA 8984-03
60 x 130 mm	MA 8984-04
75 x 140 mm	MA 8984-05
75 x 175 mm	MA 8984-06
100 x 150 mm	MA 8984-07



Ø x HØ x h	Liter Litre	Schalen Bowls
40 x 19 mm	0,05 l	MA 8985-10
61 x 30 mm	0,07 l	MA 8985-11
80 x 40 mm	0,14 l	MA 8985-01
116 x 50 mm	0,35 l	MA 8985-02
128 x 55 mm	0,45 l	MA 8985-03
147 x 65 mm	0,70 l	MA 8985-04
167 x 75 mm	1,10 l	MA 8985-05
187 x 85 mm	1,60 l	MA 8985-06

M.ASHRAF
INSTRUMENTS

Runde Behälter Round Bowls



Ø x HØ x h	Schalen Bowls
120 x 35 mm	MA 8986-12
140 x 35 mm	MA 8986-14
160 x 35 mm	MA 8986-16



Typ Type	Ø x HØ x h	Liter Litre	Schalen Bowls
B1	40 x 19 mm	0,02 l	MA 8987-01
B2	61 x 30 mm	0,06 l	MA 8987-02
B4	83 x 41 mm	0,16 l	MA 8987-03
B6	111 x 56 mm	0,40 l	MA 8987-04
B8	151 x 73 mm	1,00 l	MA 8987-05
B10	211 x 76 mm	2,50 l	MA 8987-06

M.ASHRAF
INSTRUMENTS



Ø x HØ x h	Liter Litre	Schalen Bowls
165 x 55 mm	0,75 l	MA 8988-01
175 x 70 mm	1,00 l	MA 8988-02
225 x 100 mm	2,00 l	MA 8988-03
240 x 90 mm	2,75 l	MA 8988-04
260 x 120 mm	4,00 l	MA 8988-05
315 x 105 mm	5,50 l	MA 8988-06
325 x 135 mm	8,00 l	MA 8988-07
380 x 130 mm	11,00 l	MA 8988-08
405 x 150 mm	14,00 l	MA 8988-09

Instrumentenschalen Instrument Trays



	Instrumentenablageplatten <i>Instrument storage trays</i>
160 x 210 x 10 mm	MA 8977-01
240 x 180 x 10 mm	MA 8977-02
280 x 210 x 10 mm	MA 8977-03
300 x 160 x 10 mm	MA 8977-04
310 x 210 x 10 mm	MA 8977-05
400 x 270 x 10 mm	MA 8977-06



L x B x H / x b x h	Schalen <i>Trays</i>
330 x 230 x 30 mm	MA 8978-01
350 x 250 x 30 mm	MA 8978-02
350 x 250 x 50 mm	MA 8978-04

M.ASHRAF
INSTRUMENTS



Instrumentenkasten
Instrument box

205 x 105 x 40 mm
MA 8979-00

Instrumentenschalen Instrument Trays



L x B x H / l x b x h	Instrumentenkasten <i>Instrument box</i>
165 x 90 x 35 mm	MA 8980-01
200 x 100 x 50 mm	MA 8980-02
220 x 150 x 50 mm	MA 8980-03
260 x 150 x 50 mm	MA 8980-04
305 x 205 x 50 mm	MA 8980-05
420 x 80 x 40 mm	MA 8980-06



Schalen
Trays

235 x 190 x 40 mm
MA 8989-00

M.ASHRAF
INSTRUMENTS

Siebkörbe, Größe 1/2 Baskets, Half Size

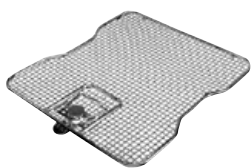

Deckel für Drahtsiebkorb
Lid for wire basket

240 x 215 mm **CS140-000**

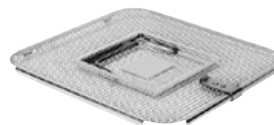

Deckel für Siebkorb
Lid for perforated basket

240 x 240 mm **CS141-000**



Drahtsiebkorb
Wire basket

255 x 245 x 30 mm **CS140-030**

255 x 245 x 50 mm **CS140-050**

255 x 245 x 70 mm **CS140-070**

255 x 245 x 100 mm **CS140-100**



Siebkorb
Perforated basket

240 x 240 x 41 mm **CS141-041**

240 x 240 x 45 mm **CS141-045**

240 x 240 x 50 mm **CS141-050**

240 x 240 x 70 mm **CS141-070**

240 x 240 x 90 mm **CS141-090**

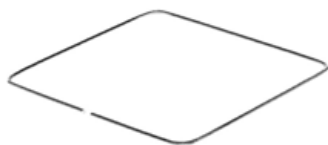

Spannrahmen für Drahtsiebkorb
Drape retainer for wire basket

255 x 255 mm **CS146-000**

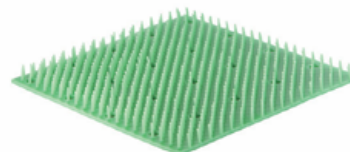

Silikon-Noppenmatte für
Drahtsiebkorb und Siebkorb
Silicone stud mat for baskets

240 x 220 mm **CS147-001**



Füße (Kunststoff), für Drahtsiebkorb
Feet (Plastic), for wire basket

4 Stk./pcs. **CS141-100**

Siebkörbe, Größe 3/4 Baskets, Three-Quarter Size

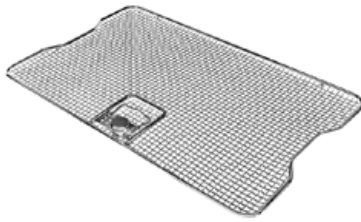

Deckel für Drahtsiebkorb
Lid for wire basket

375 x 240 mm **CS240-000**



Deckel für Siebkorb
Lid for perforated basket

380 x 240 mm **CS241-000**

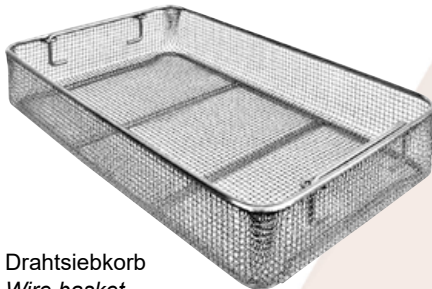

Drahtsiebkorb
Wire basket

405 x 255 x 30 mm **CS240-030**

405 x 255 x 50 mm **CS240-050**

405 x 255 x 70 mm **CS240-070**

405 x 255 x 100 mm **CS240-100**



Siebkorb
Perforated basket

380 x 240 x 41 mm **CS241-041**

380 x 240 x 45 mm **CS241-045**

380 x 240 x 50 mm **CS241-050**

380 x 240 x 70 mm **CS241-070**

380 x 240 x 90 mm **CS241-090**

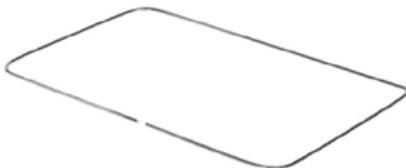

Spannrahmen für Drahtsiebkorb
Drape retainer for wire basket

405 x 255 mm **CS246-000**

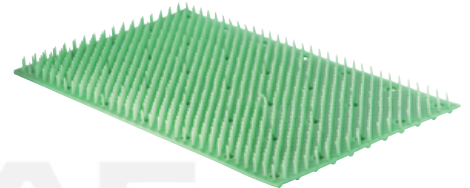

Silikon-Noppenmatte für
Drahtsiebkorb und Siebkorb
*Silicone stud mat for wire basket
and perforated basket*

380 x 220 mm **CS247-000**



Füße (Kunststoff), für Drahtsiebkorb
Feet (Plastic), for wire basket

4 Stk./pcs. **CS141-100**

Siebkörbe, Größe 1/1 Baskets, Full Size

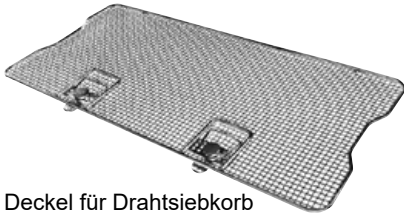

Deckel für Drahtsiebkorb
Lid for wire basket

455 x 240 mm **CS340-000**

510 x 240 mm **CS341-000**

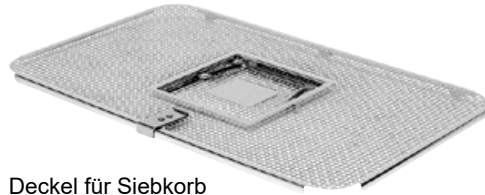

Deckel für Siebkorb
Lid for perforated basket

480 x 240 mm **CS342-000**

510 x 240 mm **CS343-000**

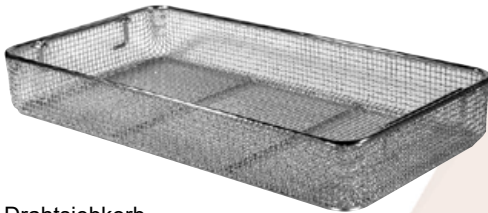

Drahtsiebkorb
Wire basket

485 x 255 x 30 mm **CS340-030**

485 x 255 x 50 mm **CS340-050**

485 x 255 x 70 mm **CS340-070**

485 x 255 x 100 mm **CS340-100**

540 x 255 x 30 mm **CS341-030**

540 x 255 x 50 mm **CS341-050**

540 x 255 x 70 mm **CS341-070**

540 x 255 x 100 mm **CS341-100**

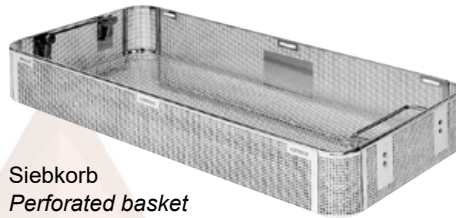

Siebkorb
Perforated basket

480 x 240 x 41 mm **CS342-041**

480 x 240 x 45 mm **CS342-045**

480 x 240 x 50 mm **CS342-050**

480 x 240 x 70 mm **CS342-070**

480 x 240 x 90 mm **CS342-090**

540 x 240 x 41 mm **CS343-041**

540 x 240 x 45 mm **CS343-045**

540 x 240 x 50 mm **CS343-050**

540 x 240 x 70 mm **CS343-070**

540 x 240 x 90 mm **CS343-090**

540 x 240 x 70 mm **CS343-180**

M.ASHRAF
INSTRUMENTS

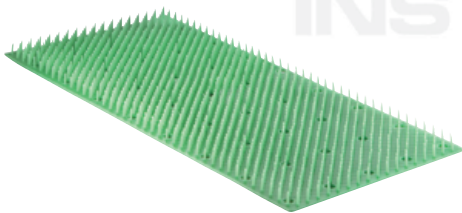

Silikon-Noppenmatte für
Drahtsiebkorb und Siebkorb
*Silicone stud mat for wire basket
and perforated basket*

480 x 220 mm **CS347-000**

500 x 220 mm **CS348-000**



Spannrahmen für Drahtsiebkorb
Drape retainer for wire basket

545 x 255 mm **CS346-000**

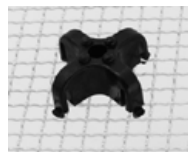

Füße (Kunststoff), für Drahtsiebkorb
Feet (Plastic), for wire basket

4 Stk./pcs. **CS141-100**

Siebkörbe, Größe Mini Baskets, Mini Size



Drahtsiebkorb
Wire basket

265 x 120 x 45 mm

CS540-045



Spannrahmen für Drahtsiebkorb
Drape retainer for wire basket

300 x 140 mm

CS546-000



Silikon-Noppenmatte für
Drahtsiebkorb und Siebkorb
*Silicone stud mat for wire basket
and perforated basket*

300 x 140 mm

CS547-000



Füße (Kunststoff), für Drahtsiebkorb
Feet (Plastic), for wire basket

4 Stk./pcs.

CS141-100

M.ASHRAF
INSTRUMENTS

Siebkörbe, Größe Mini Baskets, Mini Size



Minikorb mit Deckel
Mini basket with lid

- 1 Instrumentenhalter im Deckel
- 2 Instrumentenhalter im Körper
- 1 Instrument holder in the lid*
- 2 Instrument holders in the basket*

170 x 50 x 30 mm **CS050-001**



Minikorb mit Deckel
Mini basket with lid

- 2 Instrumentenhalter im Deckel
- Silikon-Noppenmatte im Körper
- 2 Instrument holders in the lid*
- Silicone mat in the basket*

170 x 50 x 30 mm **CS050-002**

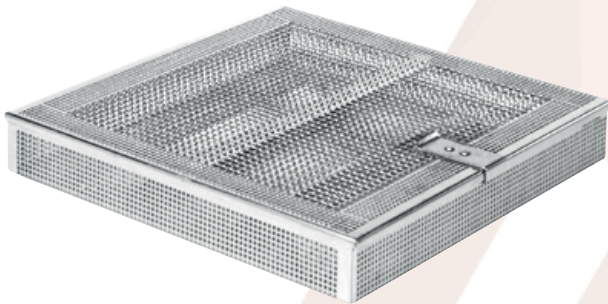

Minikorb mit Deckel
Mini basket with lid

- 1 Instrumentenhalter im Deckel
- 2 Instrumentenhalter im Körper
- 1 Instrument holder in the lid*
- 2 Instrument holders in the basket*

240 x 240 x 35 mm **CS050-005**

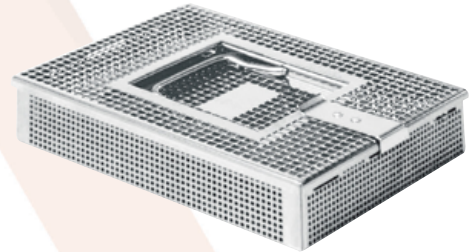

Minikorb mit Deckel
Mini basket with lid

- 1 Instrumentenhalter im Deckel
- Silikon-Noppenmatte im Körper
- 1 Instrument holder in the lid*
- Silicone mat in the basket*

135 x 170 x 35 mm **CS050-003**

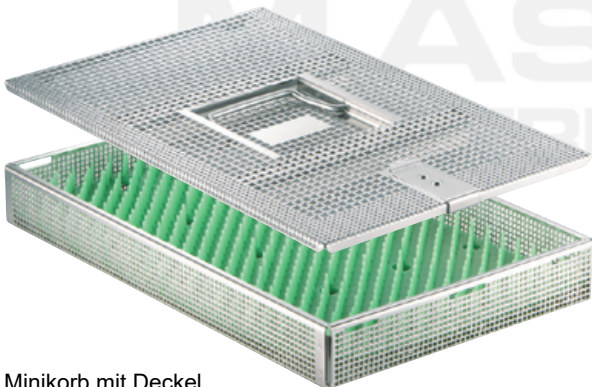

Minikorb mit Deckel
Mini basket with lid

- 2 Instrumentenhalter im Deckel
- Silikon-Noppenmatte im Körper
- 2 Instrument holders in the lid*
- Silicone mat in the basket*

270 x 170 x 35 mm **CS050-004**

Zubehör Accessories

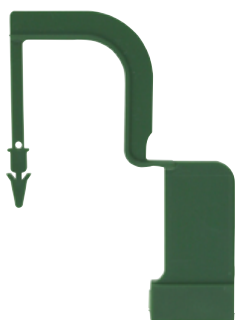

Verschlussplombe
Seal

1000 Stück / Packung
1000 pieces / package

CS950-028



Entsorgungsmarke
für Drahtsiebkörbe

*Metal label for
wire basket*

unbeschriftet
unlabeled

CS961-020



Entsorgungsmarke
für Drahtsiebkörbe

*Metal label for
wire basket*

beschriftet
labeled

CS961-021



Karabinerhaken
Carabiner

MA 8906-01



Edelstahlplakette
Ø 20 mm
Stainless steel tag
Ø 20 mm

CS961-030

Identifikationsklebebänder autoklavierbar
6,4 mm breit / 7,62 m pro Rolle Identification
adhesive tape, autoclavable
6.4 mm wide / 7.62 m per roll

rot – red  **MA 8884-01**

gelb – yellow  **MA 8884-02**

orange – orange  **MA 8884-03**

blau – blue  **MA 8884-04**

grün – green  **MA 8884-05**

braun – brown  **MA 8884-06**

weiß – white  **MA 8884-07**

schwarz – black  **MA 8884-08**

violett – violet  **MA 8884-09**





Sortierspieß
Holding pin

CS956-001



Trennblechhaltestift
Partition holding pin

CS956-002



Trennblech
Partition sheet

50 x 20 mm **CS956-010**

130 x 20 mm

225 x 20 mm

460 x 20 mm



Fixierklammer
Fixation clamp

24 x 28 x 25 mm Ø 7 x 12 mm **CS961-011**

24 x 28 x 29 mm Ø 12 x 16 mm **CS961-012**

24 x 28 x 31 mm Ø 16 x 26 mm **CS961-013**

24 x 28 x 40 mm Ø 26 x 36 mm **CS961-014**

24 x 28 x 44 mm Ø 36 x 45 mm **CS961-015**



Tuchklammer
Drape clamp

CS961-010



Doppelte Spiralfeder
Double spiral holder

CS956-021



Spiralfeder
Spiral holder

CS956-020



Einschlagtuch aus Baumwolle
Wrapping drape, cotton

60 x 40 cm **MA 8906-31**

90 x 40 cm **MA 8906-32**

130 x 40 cm **MA 8906-33**

85 x 85 cm **MA 8906-34**

130 x 85 cm **MA 8906-35**

160 x 80 cm **MA 8906-36**

160 x 100 cm **MA 8906-37**

160 x 160 cm **MA 8906-38**

240 x 160 cm **MA 8906-39**

Bereitstellungstische Trolleys



Sterilgut-Bereitstellungstisch, mobil,
für 1 großen Container
Tischplatte 660 x 400 mm
Gesamthöhe 850 mm
- Lagerungsschienen für Deckelablage
- 1 Regalboden
- Rollen mit Feststellbremse

*Sterile good table, mobile,
for 1 full size container table
surface 660 x 400 mm total
height 850 mm*

- deposit rails for container lid
- 1 shelf
- wheels with fixing brake

CS980-010



Sterilgut-Bereitstellungstisch, mobil,
für 2 große Container
Tischplatte 660 x 640 mm
Gesamthöhe 850 mm
- Lagerungsschienen für Deckelablage
- 1 Regalboden
- Rollen mit Feststellbremse

*Sterile good table, mobile,
for 2 full size containers table
surface 660 x 640 mm total
height 850 mm*

- deposit rails for container lids
- 1 shelf
- wheels with fixing brake

CS980-011



Sterilgut-Regalwagen, offen
1165 x 700 mm (L x B) Gesa-
mthöhe 1310 mm - 4 Regal-
böden

- Rollen mit Feststellbremse

Sterile good transport trolley, open

1165 x 700 mm (l x w)

total height 1310 mm

- 4 shelves

- wheels with fixing brake

CS980-012



Sterilgut-Regalwagen, geschlossen

1190 x 720 mm (L x B)

Gesamthöhe 1465 mm

- 2 Regalböden

- Rollen mit Feststellbremse

Sterile good transport trolley, closed

1190 x 720 mm (l x w)

total height 1465 mm

- 2 shelves

- wheels with fixing brake

CS980-013

Thirteen



Elevators

Adson Periosteal Elevator

- 16cm/6¼" length
- Curved blunt

	Width
MA3055-16	5mm
MA3007-16	7mm



Pennybacker Periosteal Elevator

- 16cm/6¼" length
- Curved sharp

	Width
MA3064-16	4mm
MA3066-16	6mm
MA3068-16	8mm



Bone Raspatory with Tufnol Handle

- 19cm/7½" length



Straight 6mm	Width
MA7016-19	

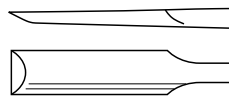

Curved 3mm	Width
HA7023-19	
HA7026-19	6mm

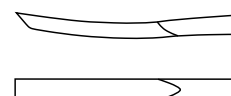

Farabeuf Rugine Elevator

- 15cm/6" length

Straight 12mm	Width
MA3001-15	

Curved* 12mm	Width
MA3002-15	



*illustrated

Farabeuf Rugine Elevator with Hollow Handle

- 16cm/6¼" length

Straight 12mm	Width
MA3011-16	

Curved* 12mm	Width
MA3012-16	



*illustrated

Elevators

Trethowan Bone Elevator

- 22.5cm/8½" length

MA3030-22



Lanes Bone Elevator

- 26cm/10" length

MA3031-26



Fagge Bone Elevator

- 27.5cm/10¾" length

MA3032-27



Bristow Periosteal Elevator

- 23cm/9" length
- Curved sharp
- 10mm width

MA3003-23



Femoral Dislocation Lever

- 31cm/12½" length
- 26mm width

MA3026-31



Muller Femoral Retractor

- 35cm/13½" length
- 28mm width

MA3028-35



For retraction of the femoral neck.

Mini Elevators

Mini Bone Lever

- 14cm/5½"
- 2.8mm width

MA5830-14



Hohmann Style Mini-Bone Lever

- 16cm/6¼"
- 6mm width

MA5831-16



Phalangeal Lever

- 15cm/6"
- 5mm width

MA5832-16



Buck-Gramcko Lever

- 15cm/6"
- 7.5mm width

MA5833-15



Mini-Cobra Bone Lever

- 16cm/6¼"
- 15mm width

MA5834-16



McGlamry Metatarsal Elevator

- 17cm/6½"
- Sharp

Width

MA5835-10	9mm
MA5835-12	11mm
MA5835-14	13mm
MA5835-16	15mm
MA5835-19	19mm



Elevators

Hohmann Bone Elevator

- 22cm/8½" length
- 8mm width

MA3008-22



Hohmann Bone Elevator

- 24cm/9½" length
- 18mm width

MA3018-24



Hohmann Bone Elevator

- 24.5cm/9½" length
- 43mm width

MA3043-24



Hohmann Large Bone Elevator

- 24cm/9½" length
- 70mm width

MA3070-24



Hohmann Bone Elevator

- 28cm/11" length
- 33mm width

MA3033-28



Hohmann Bone Elevator

- 26cm/10" length
- 24mm width

MA3024-26



Elevators

Long Curved Hohmann Inferior Hip Elevator

- 40cm/16" length
- 22mm width

MA3022-40



Modified Hohmann Elevator

- 90° angled

Width

MA7750-10	10mm
MA7750-18	18mm
MA7750-25	25mm
MA7750-43	43mm
MA7750-70	70mm



Modified Cobra Aufrang Elevator

- 33cm/13" long blade
- 30mm x 100mm

MA7742-10

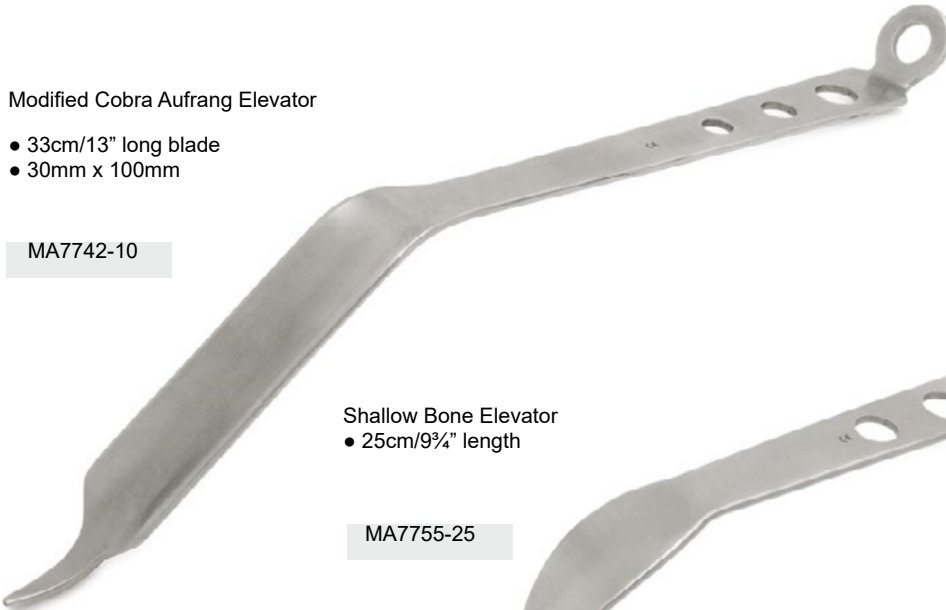

Shallow Bone Elevator

- 25cm/9 3/4" length

MA7755-25



Concave Moor Elevator

- 33cm/13" long blade

MA7742-20

Elevators

Murphy Bone Skid Elevator

- 23cm/9" length
- For dislocation of the femoral head
- Double ended

MA0589-23



Murphy Insulated Bone Skid Elevator

- 33cm/13" length
- Double ended

MA3035-33

Infero-Posterior Acetabular Capsule Retractor

- 35cm/14" length

Right

MA7772-10

Left

MA7772-20

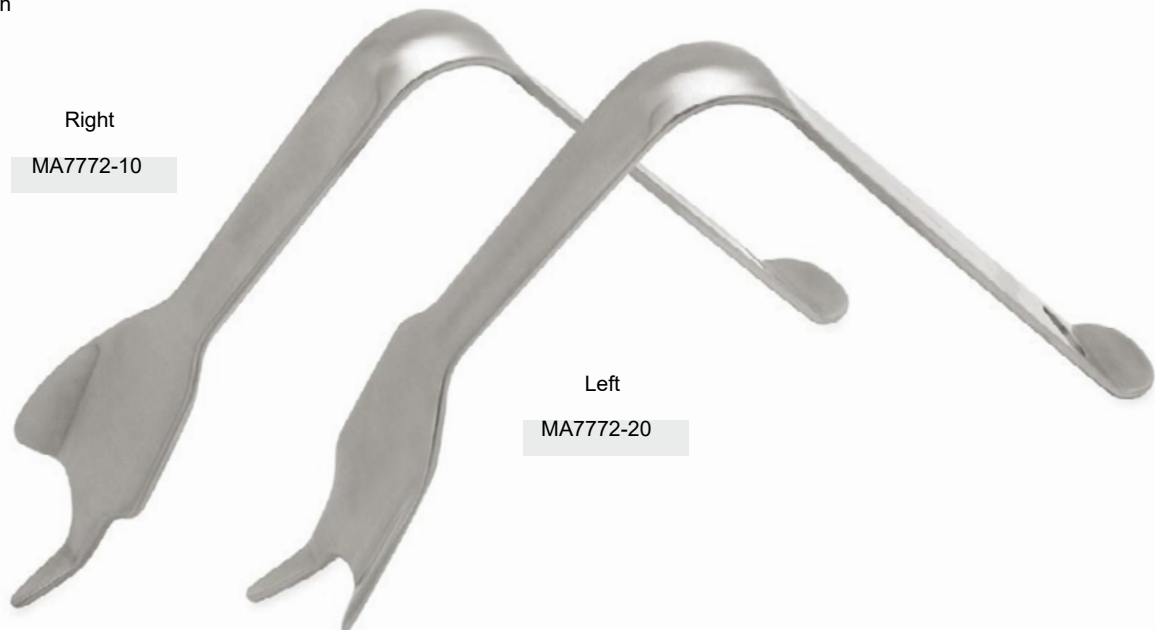

PCL Retractor

- 25cm/10" length
- To straddle the cruciate ligament
- 4mm wide prongs
- 21mm wide tips

MA7761-10



Wide Prong PCL Retractor

- 25cm/10" length
- To straddle the cruciate ligament
- 5mm wide prongs
- 23mm wide tips

MA7762-10



Bone Hooks

- Bone Hook Sharp
- 24.5cm/9¾" length
 - Sharp

MA9050-24



- Blunt Hook
- 20cm/8" length

MA9051-20



- Wroblenski Dislocating Hook

- 25cm/10" length
- For hooking around the neck of the Femur

MA9055-25



- McMinn Dislocating Hook

- 25cm/10" length
- Blunt hook with Tufnol handle

MA9057-25



Bone Spreaders

Scaphoid Spreader - Fine Pattern

- 14cm/5½" length
- 1 x 2 prongs

6mm

MA5131-14



Scaphoid Spreader - Standard Pattern

- 14cm/5½" length

6mm

MA5134-14



Baby Inge Bone Spreader

- 18cm/7" length

7mm
Toothed



MA5134-18

7mm
Smooth



MA5134-18S

7mm
Cross Serrated



MA5134-18X

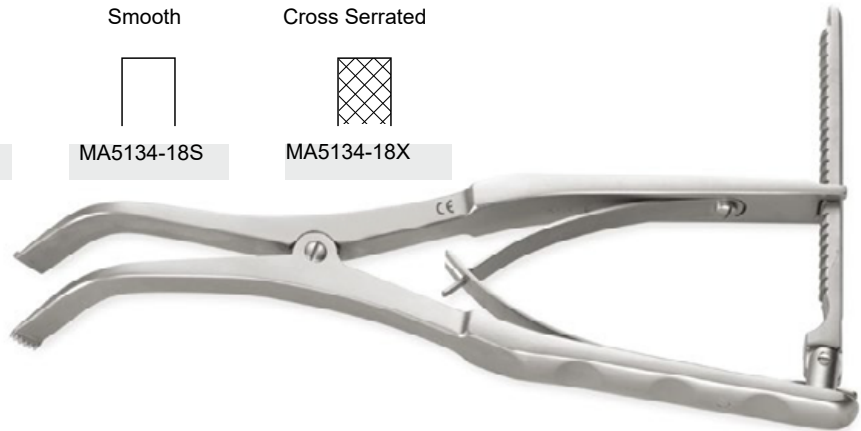

Scaglietti Lamina Spreader

- 28cm/11" length
- With speed lock



MA2009-28



Bone Cutters

Bohler Bone Cutters

- 15cm/6" length
- Double action

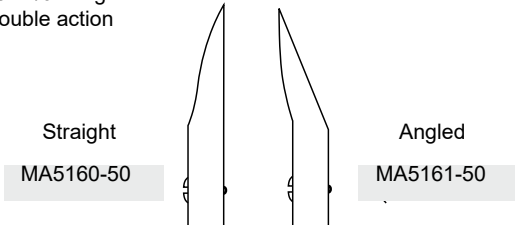

McIndoe Bone Cutters

- 18cm/7" length
- Double action
- Angled jaws

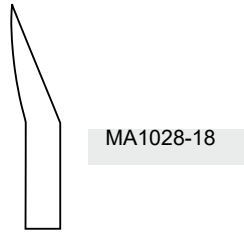

Ruskin-Liston Bone Cutters

- 19cm/7½" length
- Double action

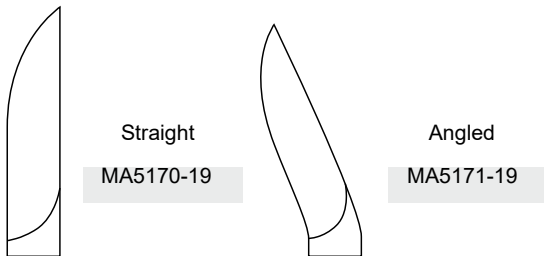

Stille-Liston Bone Cutters

- 27cm/10¾" length
- Double action

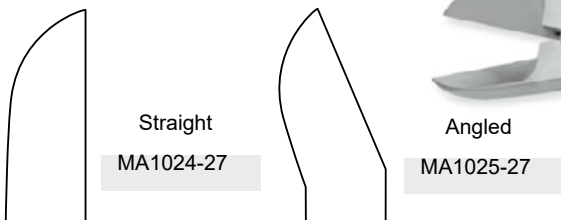

Liston-Key-Horsley Bone Cutters

- 27cm/10¾" length
- Double action
- Angled

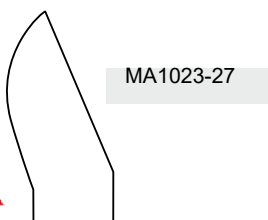

Bone Nibblers

Kleinert-Kutz Bone Nibbler

- 14cm/4½" length
- Curved

2mm Bite

MA5118-50



Lempert Bone Nibbler

- 19cm/7½" length
- Single action

3mm Bite

MA1001-19



Luer Bone Nibbler

- 18cm/7" length
- Single action

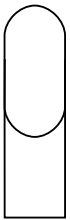

Straight
8mm Bite

MA1004-18



Curved 8mm
Bite

MA1005-18



Adsons Bone Nibbler

- 20cm/8" length
- Single action

7mm Bite

MA1040-20

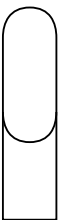

Bone Nibblers

Bohler Bone Nibbler

- Curved double action
- 15cm/6"

- 3mm Bite

MA5120-50



Marquardt Bone Nibbler

- 20cm/8" length
- Curved double action

- 3mm Bite

MA1002-20

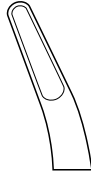

Beyer Bone Nibbler

- Curved double action
- 18cm/7"

- 4mm Bite

MA1002-18

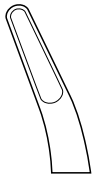

Jansen Bone Nibbler

- Curved double action
- 18cm/7"

- 5mm Bite

MA1003-18

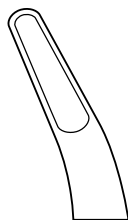

Bone Nibblers

Smith-Peterson Bone Nibbler

- 24cm/9½" length
- Double action

Straight Light Curve Bite Size

MA1010-24	MA1014-24	3mm
MA1011-24	MA1015-24	4mm
MA1012-24	MA1016-24	5mm
MA1013-24	MA1017-24	6mm

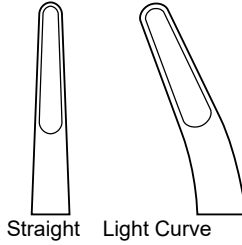

Straight Light Curve

Leksell Bone Nibbler

- 24cm/9½" length
- Double action angled

Angled Jaw Bite Size

MA1018-24	3mm
MA1019-24	5mm
MA1020-24	8mm

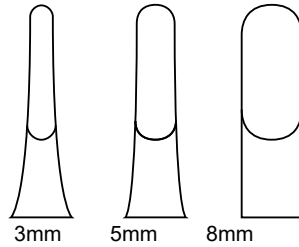

3mm 5mm 8mm



Stille-Luer Bone Nibbler

- 22cm/8¾" length
- Double action

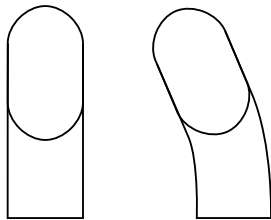

Straight
10mm Bite
MA1006-22

Curved
10mm Bite
MA1007-22



'Mr Blobby' Stille-Luer Bone Nibbler

- 26cm/10¼" length
- Double action

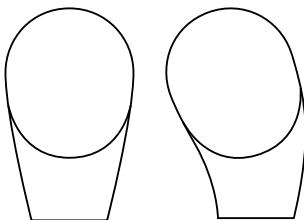

Straight
17mm Bite
MA1008-26

Curved
17mm Bite
MA1009-26



Bone Holding Forceps

Langenbeck Bone Holding Forceps

- 20cm/8" length

MA5120-05

5mm



Frosch Bone Holding Forceps

- 18cm/7" length
- Toothed/serrated jaws

MA6141-18



St. Thomas Bone Holding Forceps

- 18cm/7" length
- Screw joint

MA6170-18



Fergusson Bone Holding Forceps

- 20cm/8" length
- Screw joint

MA6140-20



Langenbeck Bone Holding Forceps

- 21cm/8 1/4" length

MA6144-21



Bone Holding Forceps

Trochanter Holding Forceps

- 21cm/9" length

MA6145-21



Semb Bone Holding Forceps

- 19cm/7½" length
- Angled to side

MA6147-18



Hey Groves Bone Holding Forceps

- Screw joints
- Serrated jaws

Length

MA6145-20	20cm/8"	Small
MA6145-25	25.5cm/10"	Medium
MA6145-30	30.5cm/12"	Large



Verbrugge Bone Holding Forceps

Length

MA6150-25	25cm/10"	Small
MA6150-26	26cm/10½"	Medium
MA6150-27	27cm/11"	Large



Hintermann Distractors

The Hintermann Distractor is used in foot and ankle surgery for bone distraction as an alternative to Lamina spreaders. The instrument can be locked and applies distraction across two K-wires placed on either side of a joint.

The spreader is then distracted, and locked when the required distance between the two bone fragments is reached.

Two K-wires (either 1.6 or 2.5mm Ø) are introduced into the correct holes in the spreading arms, and penetrate the bone at appropriate position into each of the two bone fragments to be distracted.

The Hintermann offers flexible positioning with the advantage of not interfering with the procedure.

These distractors are available in two different sizes (15cm or 21cm), and with closed or outspread arms, allowing them to fit different indications.

Hintermann Distractor with closed arms

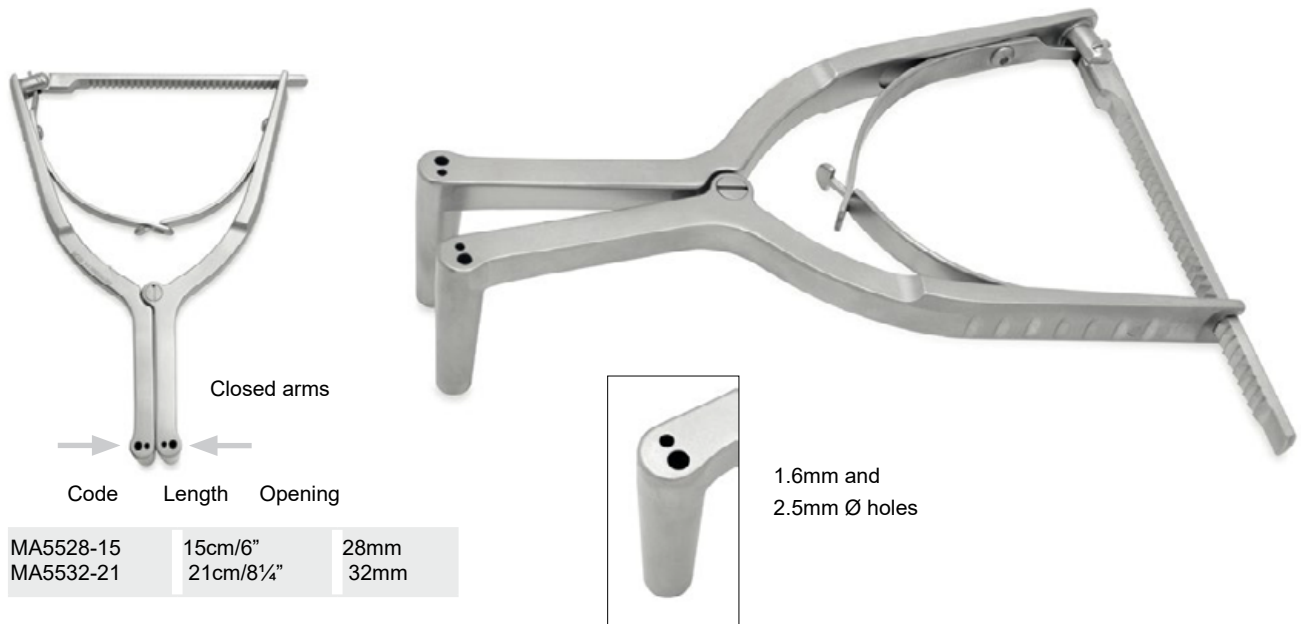

Hintermann Distractor with open arms - for wider distraction

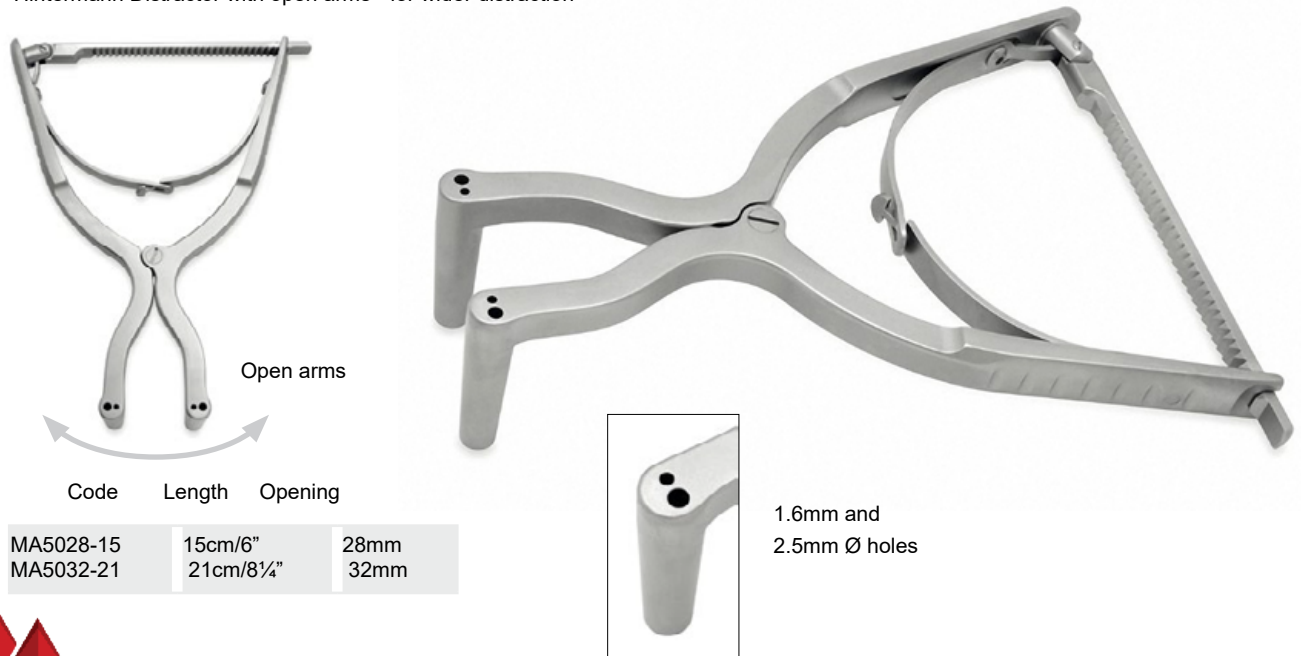

Pelvic Reduction Instruments

Pelvic Reduction Forceps

- 19cm/7½" length
- Angled, small
- Pointed ball tips
- Speed lock

MA6151-19



Pelvic Reduction Forceps

- 23cm/9" length
- Angled, large
- Pointed ball tips
- Speed lock

MA6152-23



Pelvic Reduction Forceps

- 25cm/10" length
- Straight, large
- Pointed ball tips
- Speed lock

MA6153-25



Pelvic Reduction Forceps

- 40cm/16" length
- Pointed ball tips
- Speed lock

MA6154-40



Pelvic Reduction Forceps

- 40cm/16" length
- 3 pointed ball tips
- Speed lock

MA6155-40



Retractors

Meyerding Retractor

- 22cm/9" length



Blade size

MA5050-22	50mm x 16mm
MA5075-22	70mm x 25mm
MA5090-22	90mm x 50mm

Langenbeck Retractor

- 21.5cm/8½" length



Blade size

MA5122-21	22mm x 6mm	Small
MA5145-21	45mm x 13mm	Medium
MA5165- 21	65mm x 25mm	Large
MA5190- 21	90mm x 20mm	Extra large

Volkman Catspaw Retractor

- | 21.5cm/8½" length
- | Semi sharp teeth



15 x 15mm 3 Prong

MA5015-21



15 x 20mm 4 Prong

MA5020-21

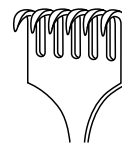

15 x 30mm 6 Prong

MA5030-21

Hip Retractors

Charnley Initial Incision Retractor Set

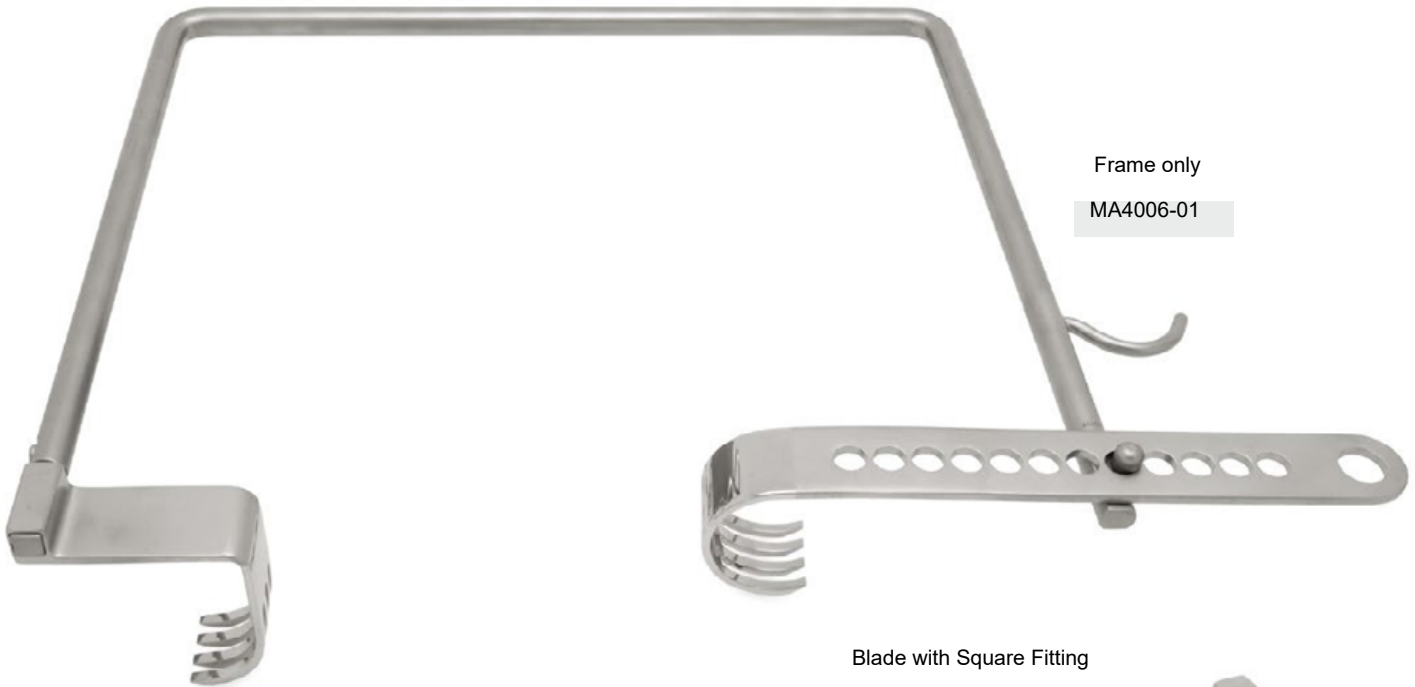

Frame only

MA4006-01

MA4006-00 Complete Set - Basic

Consisting of: •
1x Frame

- 1x Weight & chain
- 1x Square fitting blade - 50mm depth
- 1x Round fitting blade - 40mm depth

MA4006-05 Complete Set - Extended

Consisting of:

- 1x Frame
- 1x Weight & chain
- 3x Square fitting blades:
- 3x Round fitting blades:

50mm depth	40mm depth
75mm depth	75mm depth
100mm depth	100mm depth

Blade with Square Fitting



MA4006-50 Standard depth 50mm

MA4006-75 Extra depth 75mm

MA4006-100 Extra, extra depth 100mm

Blade with Round Fitting

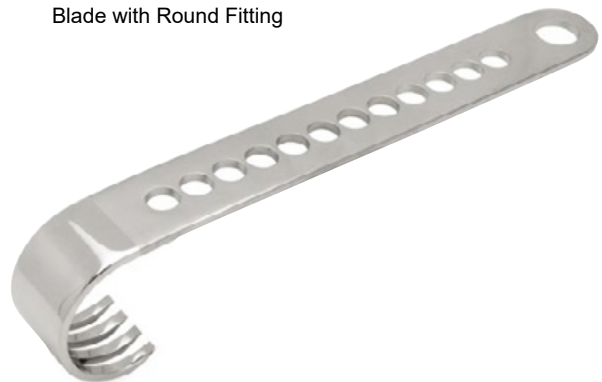

MA4007-40 Standard depth 40mm

MA4007-75 Extra depth 75mm

MA4007-100 Extra, extra depth 100mm

To spread the incision in the fascia lata. It is combined with a weight and chain, which tilts the retractor to an angle of 45° to improve exposure of the anterior aspect of the joint.



Weight & chain

MA4006-07

Retractors

West's S/R Retractor

- 14cm/5½" length
- 3x4 Sharp prongs

MA4003-14



Weitlaner S/R Retractor

- 14cm/5½" length
- 3x4 Blunt prongs

MA4002-14

Travers S/R Retractor

- 20cm/8" length
- 4x5 Blunt prongs

MA4004-20



Norfolk and Norwich S/R Retractor

- 20cm/8" length
- 4x5 Blunt prongs

MA4000-20



Gelpi Laminectomy Retractor

- Sharp prongs

	Length	Prong depth
MA4030-16	18.5cm/7¼"	30mm
MA4050-16	19.5cm/7¾"	50mm
MA4070-16	20cm/8"	70mm



Charnley Vertical Retractor

- 24.5cm/9½" length
- 3x4 Sharp prongs
- Blade depth 22mm

MA4007-24



Cones Self Retaining Retractor

- 3x4 Prongs
- Jointed arms

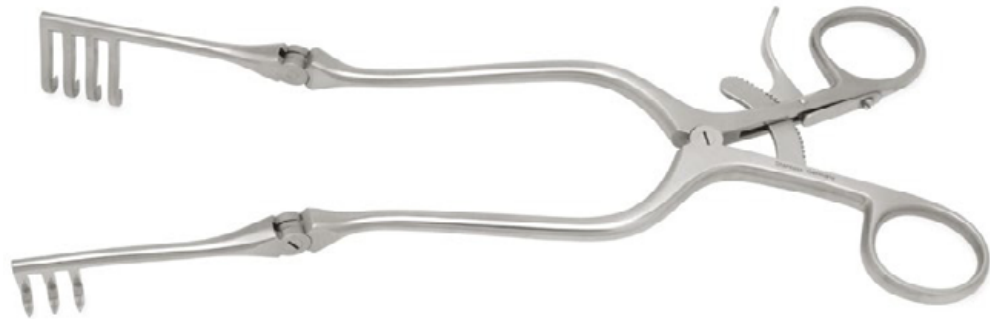

Blunt Prongs	Length	Depth	Sharp Prongs	Length	Depth
MA4064-13	13cm/5"	15mm	MA4063-13	13cm/5"	15mm
MA4066-16	16cm/6½"	15mm	MA4065-16	16cm/6½"	15mm
MA4068-20	20cm/8"	20mm	MA4067-20	20cm/8"	20mm
MA4070-24	24cm/9½"	25mm	MA4069-24	24cm/9½"	25mm

Harvey Jackson Self Retaining Retractor

- 30.5cm/12" length
- Blade depth 45mm
- 3x3 Sharp prongs

MA4010-30



Retractors

Charnley Horizontal Hip Retractor

- 28cm/11" length
- Blade depth 18mm
- Hinged joint
- 7" opening

MA4006-28

To retract the detached trochanter headwards, and the femur towards the feet



Hardinge Horizontal Retractor

- Blade depth 18mm
- Hinged joint

MA4007-28



Charnley Pin Retractor

Complete set with:

- T-handle introducer
- Pair of pins with chains

MA1100-00

MA1101-00 T-handle only



Pair of pins with chain only

MA1102-00



One pin, or sometimes two, is driven into the bone of the superior lip of the acetabulum, to stake back the capsule to give a clear view of the superior lip of the acetabulum. The nerve supply to the tensor fasciae femoris is preserved in this exposure by restricting dissection in the cleft in front of the gluteus medius, but this restricts exposure. By using pins to stake back the abductor muscles, a good exposure of the acetabulum can be obtained, and at the same time the nerve supply to tensor fasciae femoris can be preserved.

The short pins do not obstruct the surgeon's hand in access to the acetabulum. The chain is a safety device to prevent the pins being left in situ.

Retractors

Viper Hinged Scoliosis Retractor

- 30cm/11¾" length
- Sharp

Depth Prongs

MA7248-38H	40mm
MA7248-40H	70mm
MA7248-50H	100mm

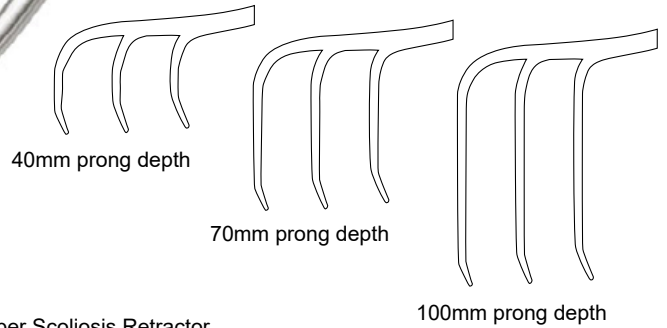
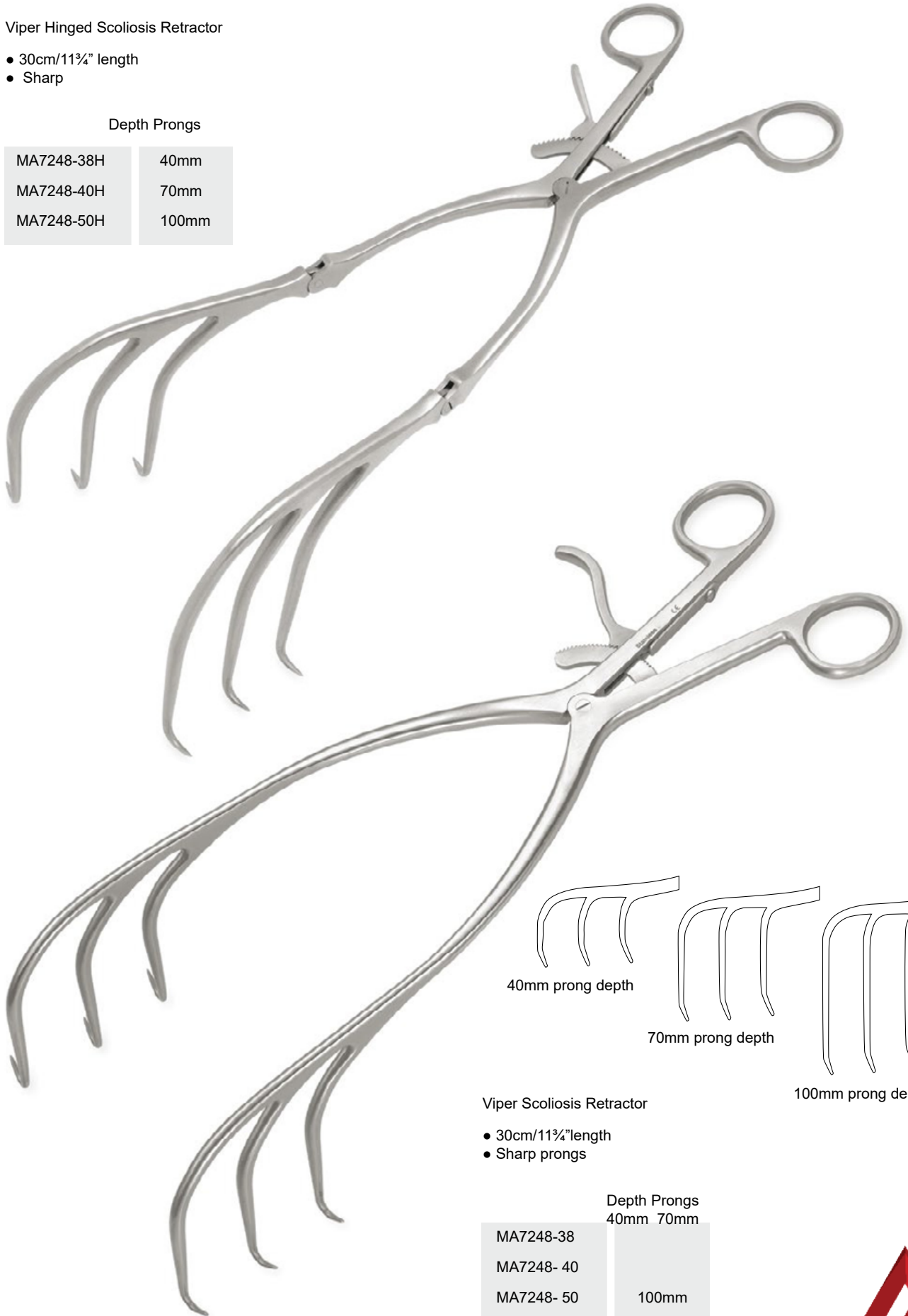

Viper Scoliosis Retractor

- 30cm/11¾" length
- Sharp prongs

Depth Prongs

MA7248-38	40mm	70mm
MA7248-40		
MA7248-50		100mm

Mallets

Toffee Mallet

- | 19cm/7½" length
- | Head size 22mm Ø
- | Weight 165g/6oz

MA5808-21



Ultra Fine Mallet

- | 17cm/6¾" length
- | Head size 20mm Ø
- | Weight 145g/5oz

MA5801-17



Heath Mallet

- 19cm/7" length
- Stainless steel head
- Head size 40mm Ø
- Weight 1020g/36oz

MA5809-19



Mallet with Tufnol Handle

- 23cm/9" length
- Small head size 30mm Ø
- Weight 350g/12oz

MA5803-23

- Medium head size 35mm Ø
- Weight 550g/20oz

MA5804-23



- Large head size 40mm Ø
- Weight 700g/25oz

MA5805-23

Mallets

London Splint Mallet
| 18cm/7" length
| Head size 30mm Ø
| Weight 450g/16.2oz

MA5802-18



Ombredanne Mallet

- 24cm/9½" length
- Head size 40mm Ø
- Weight 550g/20oz

MA5806-24



Mallet with Tufnol Handle

- 24cm/9½" length
- Lead filled head
- Weight 400g/14oz

MA5810-24



Tufnol Mallet

- | 25.5cm/10" length
- | Head size 42mm Ø
- | Weight 250g/10oz

MA5807-25



Osteotomes

Mini-Lambotte Osteotome

| 12.5cm/5" length



Width

MA5270-02	2mm
MA5270-03	3mm
MA5270-04	4mm
MA5270-06	6mm
MA5270-08	8mm

Set of 5 sizes:
2mm to 8mm

MA5270-28

Lambotte Osteotome

25cm/9¾" length



Straight Width

MA7970-04	4mm
MA7970-06	6mm
MA7970-08	8mm
MA7970-10	10mm
MA7970-13	13mm
MA7970-15	15mm
MA7970-18	18mm
MA7970-20	20mm
MA7970-25	25mm
MA7970-30	30mm

Curved Width

MA7971-04	4mm
MA7971-06	6mm
MA7971-08	8mm
MA7971-10	10mm
MA7971-13	13mm
MA7971-15	15mm
MA7971-18	18mm
MA7971-20	20mm
MA7971-25	25mm
MA7971-30	30mm

Ultra Fine Osteotome (Titanium Nitrate Coated)

| 16cm/6¼" length



Width

MA5230-02	2mm
MA5230-04	4mm
MA5230-06	6mm
MA5230-08	8mm
MA5230-10	10mm
MA5230-12	12mm

Set of 6 sizes: 2mm to 12mm complete with mallet in sterilising case

MA5230-48

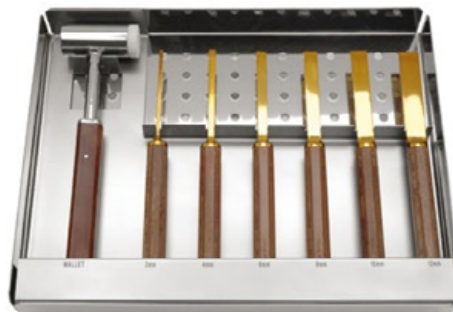

Osteotomes

Mini-Stillie Osteotome

16cm/6¼" length

Straight Width

MA7704-16	4mm
MA7706-16	6mm
MA7708-16	8mm



Stille (Swedish) Osteotome

• 20cm/8" length

Straight Width

MA7706-20	6mm
MA7708-20	8mm
MA7710-20	10mm
MA7712-20	12mm
MA7715-20	15mm
MA7720-20	20mm
MA7725-20	25mm
MA7730-20	30mm



Hibbs Osteotome with thin blade

• 20cm/8" length

• Extra thin blade

Straight Width

MA7804-20	4mm
MA7806-20	6mm
MA7808-20	8mm
MA7810-20	10mm
MA7812-20	12mm
MA7815-20	15mm
MA7820-20	20mm
MA7825-20	25mm
MA7830-20	30mm

Curved Width

MA7904-20	4mm
MA7906-20	6mm
MA7908-20	8mm
MA7910-20	10mm
MA7912-20	12mm
MA7915-20	15mm
MA7920-20	20mm
MA7925-20	25mm
MA7930-20	30mm



Smith Petersen Osteotome

• 20cm/8" length

Width

MA7610-20	10mm
MA7615-20	15mm
MA7620-20	20mm
MA7625-20	25mm
MA7630-20	30mm



Osteotomes

Mini-Lexer Osteotome

| 18cm/7" length

- Tufnol handle

MA5250-48

Set of 5 sizes:
2mm to 10mm

Width

MA5250-02	2mm
MA5250-04	4mm
MA5250-06	6mm
MA5250-08	8mm
MA5250-10	10mm



Lexer Osteotome

- 22cm/8½" length
- Tufnol handle

Width

MA7207-22	7mm
MA7210-22	10mm
MA7215-22	15mm
MA7220-22	20mm
MA7225-22	25mm



Dahmen Osteotome

- 30cm/12" length
- Tufnol handle

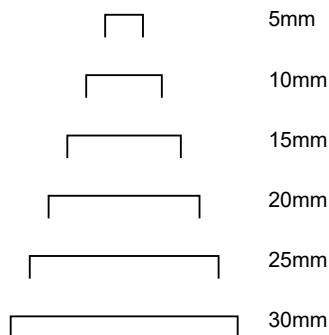

Straight Width

MA7105-30	5mm
MA7110-30	10mm
MA7115-30	15mm
MA7120-30	20mm
MA7125-30	25mm
MA7130-30	30mm

Angled Width

MA7305-30	5mm
MA7310-30	10mm
MA7315-30	15mm
MA7320-30	20mm
MA7325-30	25mm
MA7330-30	30mm

Osteotomes & Gouges

Box Chisel

- | 29cm/13½" length
- | For preparation of the proximal femur
- | 31mm width x 6mm

MA7031-29



Pelvic Osteotome

- 30cm/12" length
- Tufnol handle
- Angled shaft



15mm width
MA7015-30

20mm width
MA7020-30

Chisel with Interchangeable Blades

- 20cm/8" length
- Tufnol handle
- Very thin blades

MA0790-20

Complete set with 4 blades* & key



Blade Width
5mm*

MA0792-05	5mm*
MA0793-08	8mm
MA0793-10	10mm*
MA0793-12	12mm
MA0794-15	15mm*
MA0795-25	25mm*

Capener Lamina Gouge

- 23cm/9" length
- Cranked shaft

Width

MA6506-23	6mm
MA6508-23	8mm
MA6511-23	11mm
MA6516-23	16mm



Bone Curettes

- Volkman Curette**
- 22cm/8¾" length
 - Double ended

Size	
MA8401-22	Small
MA8402-22	Medium
MA8403-22	Large

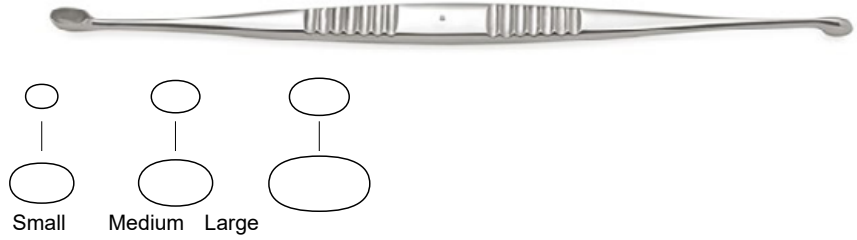

Muller Bone Curette

- 27cm/9¾" length
- Tufnol handle



Toothed Bone Curette

- 27cm/9¾" length
- Sharp spoon with teeth
- Tufnol handle

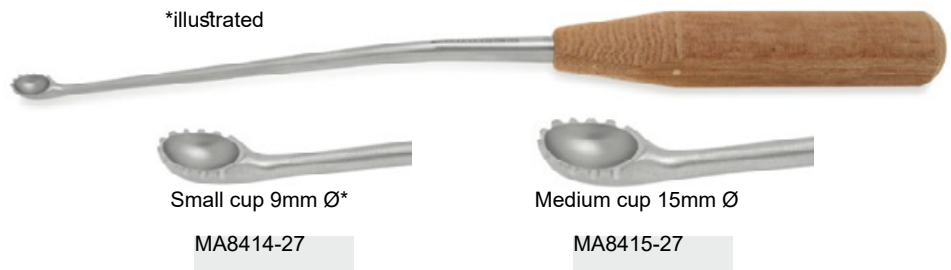

Charnley Bone Curette

- 37cm/15" length
- T-handle



Charnley Ring Curette

- 37cm/15" length
- Double sided
- Serrated cutting edge
- T-handle



Hip Revision Instruments

Cup Extraction Chisel

- 32cm/12½" length
- Curved 7mm tip
- Metal strike plate
- Tufnol handle



MA6507-32



Bayonet Gouge

- 32cm/12½" length
- Metal strike plate
- Tufnol handle
- 8mm width



MA6508-32

Swan Necked Gouge

- 28.5cm/11" length
- 25mm width



MA6525-28

Cement Gouge

- 34.5cm/13½" length



9mm width
MA6509-34

11mm width
MA6511-34

Cement Chisel Angled 15°

- 35.5cm/14 length
- 9mm tip



MA6109-35



Hip Revision Instruments

Cement Osteotome •
30cm/12" length

- Tufnol handle with strike plate

Width

MA6105- 30	5mm
MA6107- 30	7mm
MA6110-30	10mm



Cement Splitting Osteotome

- 30cm/12" length
- Tufnol handle with strike plate
- Guarded blade

Width

MA6205-30	5mm
MA6210-30	10mm



Straight Cement Gouge

- 30cm/12" length
- Tufnol handle with strike plate

Width

MA6305-30	5mm
MA6307-30	7mm
MA6310-30	10mm



Bayonet Cement Rasp

- 52cm/20½" length
- Tufnol handle

*illustrated



V-shape

MA6100-52



Strong round shape*

MA6101-52



Flat round curve

MA6102-52

Hip Revision Instruments

Bayonet Cement Chisel

- 40cm/15¾"length
- Tufnol handle with strike plate



Bayonet Cement Splitting Osteotome

- 40cm/15¾"length
- Tufnol handle with strike plate
- Guarded blade



Bayonet Cement Gouge

- 40cm/15¾"length
- Tufnol handle with strike plate



Bayonet Cement Gouge

- 40cm/15¾"length
- Tufnol handle with strike plate

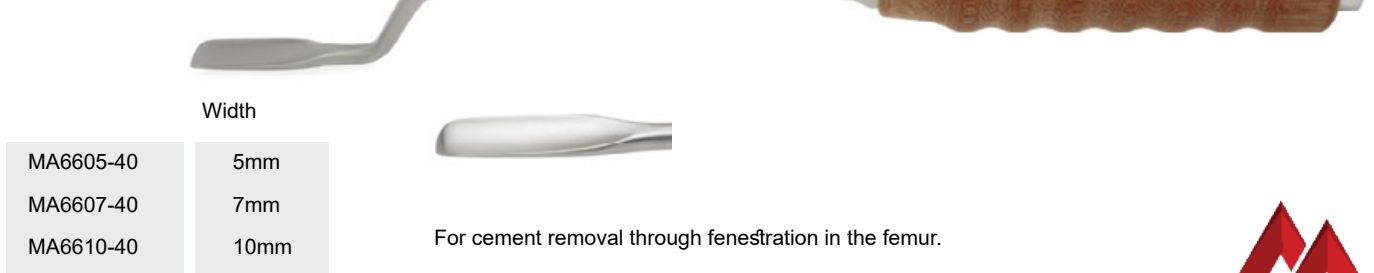

For cement removal through fenestration in the femur.

Hip Revision Instruments

Malleable Cement Probe

- 38cm/15" length
- For probing the Femur

MA6900-38



Cement Plug Extractor

- 48cm/19" length
- T-handle
- For extraction of cement plug

	Thread Dia. 7mm
MA6807-48	
MA6809-48	9mm
MA6811-48	11mm



Used with a slotted mallet

Retrograde Cement Chisel

- 50cm/19 3/4" length
- Tufnol T-handle
- Striking plate

	Width
MA6805-50	5mm
MA6807-50	7mm
MA6810-50	10mm



Slotted Mallet

MA6850-00



Cement Extraction Hook

- 34.5cm/14" length

MA6905-34

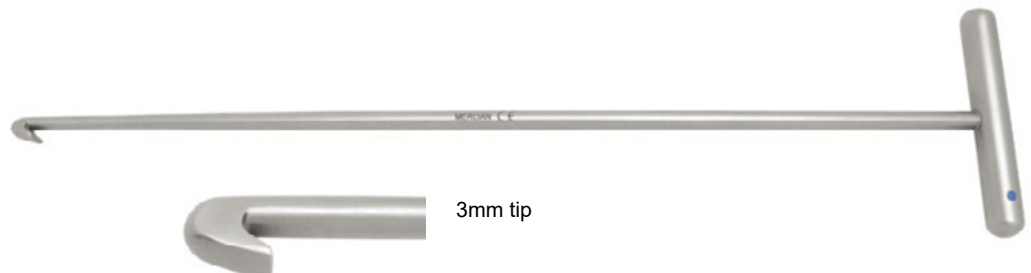

3mm tip

Hip Revision Instruments

Cement Twist Drill Long

- 40cm/15¾" length



Diameter

MA1400-06	6mm
MA1400-08	8mm
MA1400-10	10mm

Fine Cement Duckbill Grasping Forceps

- 35cm/14" shaft length
- Fine jaws



MA6901-35

Heavy Cement Grasping Forceps

- 26cm/10" shaft length
- Serrated jaws 6mm width



MA6902-26

Hip Revision Instruments

Femoral Head Extractor

- 23cm/9" length
- Tufnol handle

MA6916-23



Moore Femoral Head Extractor

- 20.5cm/8" length
- Metal handle

MA6914-20



Joint Capsule Clamp

- 21cm/8¼" length
- 25mm jaw length

MA6995-21



Joint Capsule Scissors

- 25cm/9¾" length
- Angled blades

MA6910-25



Hip Joint Instruments

Femoral Head Impactor

- 20cm/8" length
- Nylon head

MA6918-20



McGoey Bone Punch

- Double ended



* illustrated

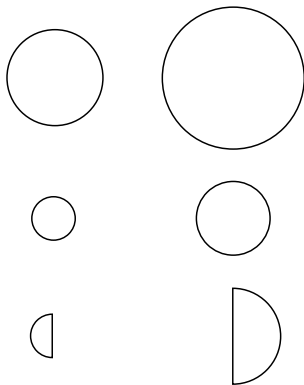

No 1. 13mm x 19mm Ø

MA6913-19

Large size

No 2. 6mm x 10mm Ø

MA6906-10

*Small size

No 3. 6mm x 13mm Ø
With flats

MA6906-13

Hardinge Cement Restrictor

- 33.5cm/13¼" length
- Graduated shaft



MA6920-33

Femoral Pusher

- Square ended



MA6925-20



Pliers & Wire Cutters

Universal Fine Pliers and Cutters

- 15cm/6" length

MA7640-15

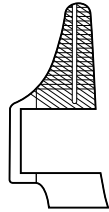

Slim & Square Ended Wire Pliers

- 19cm/7½" length

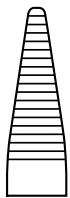

Slim Nose

MA7645-19

Serrated jaw

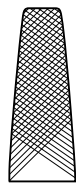

Square Ended*

MA7644-19



*illustrated

Pliers for Screw Removal

- 20cm/8" length

MA5701-20



Muller Claus Wire Pullers

- 18cm/7" length
- Double action
- Tungsten jaws

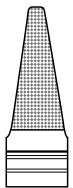

2mm Jaws
MA8-818E18

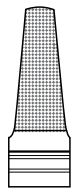

4mm Jaws
MA8-820E18

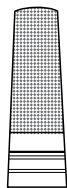

6mm Jaws
MA8-821E18

Pliers & Wire Cutters

Muller Claus Wire Cutters

- 16cm/6" length
- Tungsten carbide edges
- Cuts wire up to 1.6mm Ø

MA8-810E16



Muller Claus Wire Cutters

- Tungsten carbide edges

MA8-810E18

- 18cm/7" length*
- Cuts wire up to 2mm Ø

MA8-800E22

- 22cm/8¾" length
- Cuts wire up to 3mm Ø



*illustrated

End Wire Cutters

- 18cm/7" length
- Tungsten carbide edges
- Cuts wire up to 1.7mm Ø

MA8-816E18



Bolt Cutters with dismantable arms

- Max. cap 6.3mm pins

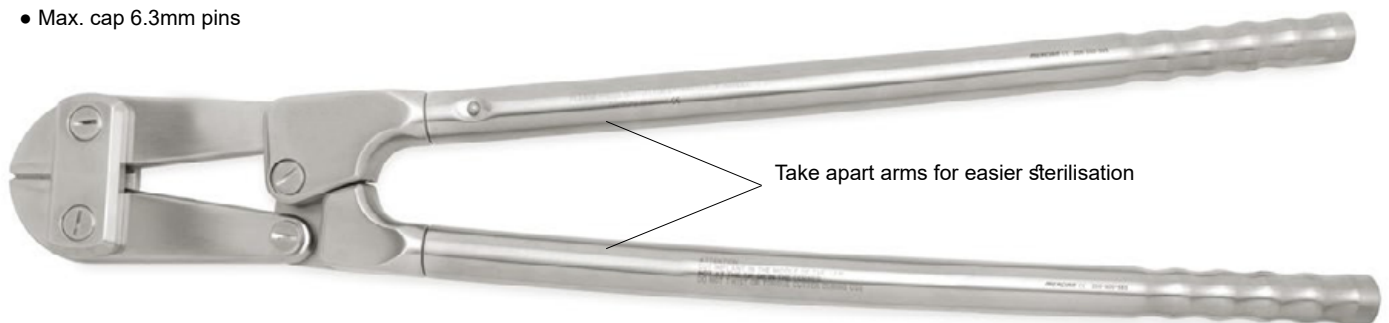

MA200-500-585

- Must be used in conjunction with a Rod Holder. Ordering Code: 200-675-200

Wire Cutters

Combined Wire Cutters & Pliers

- 18cm/7" length
- Suitable for wires up to 1.6mm Ø
- Parallel closing jaws

MA200-512-185



Wire Cutters with T/C Jaws

- 24cm/9½" length
- Double action
- Cuts plates & wires up to 2.7mm Ø

MA7644-24



'Power Cut' Wire Cutters

- 20cm/8" length
- Cutting inserts are T/C and can be replaced
- Cuts wires up to 3mm Ø

MA7645-20



Locking Pliers

Needle Nosed Locking Pliers



Code	Length	200-514-
220	22cm/8 ³ / ₄ "	Small
MA200-515-250	25cm/9 ³ / ₄ "	Medium
MA200-516-300	30cm/11 ³ / ₄ "	Large

- A very useful instrument for orthopaedic surgery allowing the surgeon to securely clamp on to wires and implants.

Pliers modified for Slap Hammer

Code	Length	200-514-
221	22cm/8 ³ / ₄ "	Small
MA200-515-251	25cm/9 ³ / ₄ "	Medium
MA200-516-301	30cm/11 ³ / ₄ "	Large

Slap Hammer attachment only		
Code	Length	Weight
MA210-400-350	35cm/13 ³ / ₄ "	400g*
MA210-700-350	40cm/15 ³ / ₄ "	700g+

*Fits pliers - small & medium size
+Fits pliers - large size

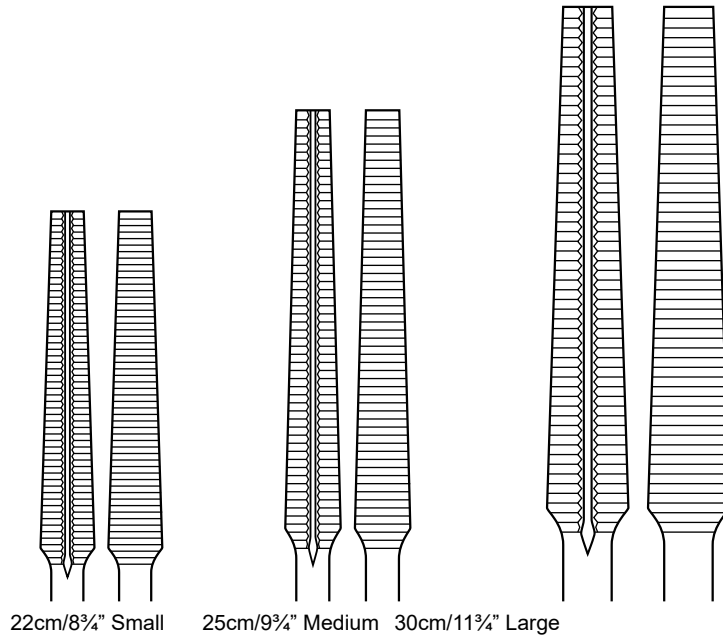

N.B. When used with slap hammer the locking pliers need modification.



Orthopaedic Locking Pliers

- Hardened jaws

Code	Length	200-511-
180	18cm/7"	Small
MA200-511-200	20cm/8"	Medium
MA200-511-240	24cm/9 ¹ / ₂ "	Large



Orthopaedic Locking Pliers modified for Slap Hammer

Code	Length	
MA200-511-181	18cm/7"	Small
MA200-511-201	20cm/8"	Medium
MA200-511-241	24cm/9 ¹ / ₂ "	Large

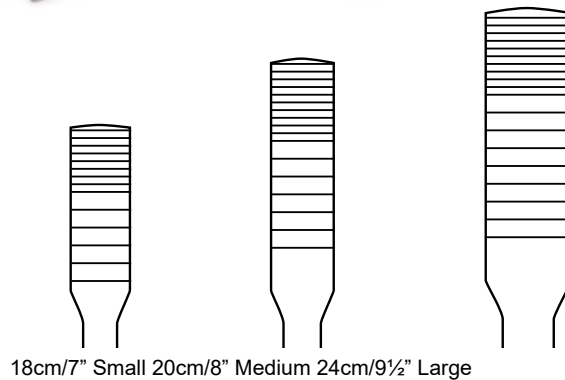

N.B. When used with slap hammer the locking pliers need modification.

Pin Introducers

Kirschner Wire Introducing T-Handle

- 12cm/4¾" length
- 1.5mm Ø wires

MA5015-12



Steinmann Pin Introducer T-Handle

- 14cm/5½" length
- 0.5mm - 8mm Ø pins
- With Jacobs chuck & key

MA5502-14



Steinmann Pin Introducer T-Handle

- 14cm/5½" length
- 0.7mm - 6mm Ø pins
- Universal chuck

MA5507-14



Bone Mill

- Table mounted with crank handle
- With removable cutting drum*

MA6001-00

For grinding bone chips used for bone graft procedures.



Cutting Drum Sizes
 * 3mm Ø hole bore
 4mm Ø hole bore
 5mm Ø hole bore

Wire Passing Guide

- 21cm/8¼" length

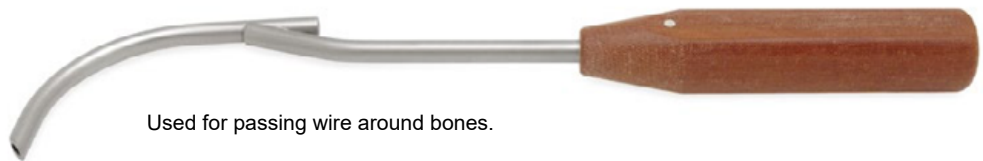

Used for passing wire around bones.

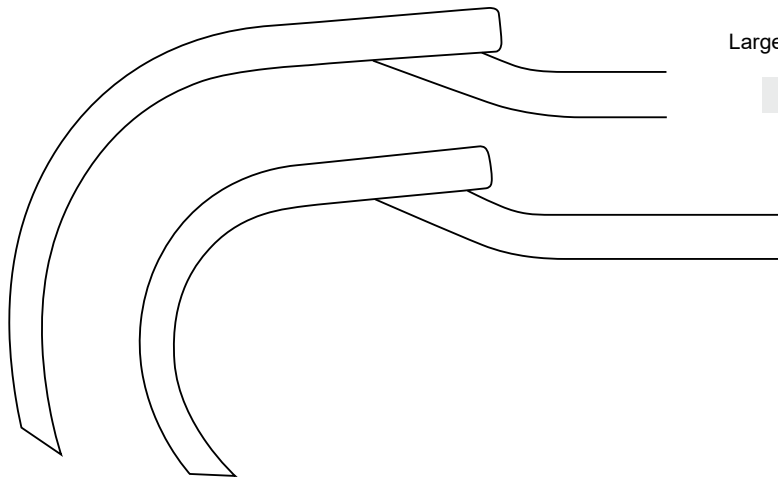

Large curve 70mm Ø

MA6105-21

Small curve 45mm Ø

MA6104-21

Bone Awl

- Straight with eye

Diameter Length

MA5602-12	2.0mm	125mm
MA5602-13	2.4mm	130mm
MA5602-14	2.8mm	145mm
MA5602-15	3.2mm	160mm
MA5602-16	3.6mm	165mm
MA5602-17	4.0mm	175mm



Screwdrivers

Slotted Head

• 17cm/6¾" length

• For head screws 2.7mm - 4.0mm

MA7014-17



Long Slotted Head

• 25cm/10" length

• For head screws 2.7mm - 4.0mm

MA7014-25



Phillips Head

• 25cm/10" length

• For small Phillips head screws 6mm

MA7015-25



Cross Slotted Head

• 25cm/10" length

• For cross slot screws 6mm

MA7016-25

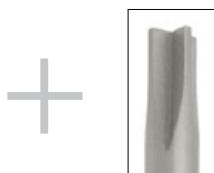

Screwdrivers

Hexagonal Head

- 25cm/10" length
- For hexagonal head screws 2.7mm - 4.0mm



Screwdriver Handle

- To fit shafts with quick lock attachment

MA7020-02



Screwdriver Handle Small

- To fit shafts with quick lock attachment

MA7020-01



Shaft with Quick Lock Fitting

- Hexagonal tip

Shaft Diameter MA7021-00

MA7022-00	2.5mm
	3.5mm



Dissectors

Howarth Elevator
• 21.5cm/8½" length



MA9207-21

MacDonald Elevator/Dissector



Size
19cm/7½"

MA7105-19

MA9206-23

23cm/9"

Watson Cheyne Dissector



Length

MA7203-18

18cm/7"

MA9203-23

23cm/9"

MA9203-25

25.5cm/10"

Freers Elevator/Dissector

• 18.5cm/7¼" length



HA7602-18

Swedish Dissector

• 18cm/7" length



MA9201-18

Measuring Instruments

Stainless Steel Measuring Ruler

Code Length

MA5005-15	15cm/6"
MA5005-30	30cm/12"



Measuring Caliper

- 25cm/10" length
- Measuring range 0-50mm

MA7334-20



Vernier Caliper

- 22.5cm/9" length
- Measuring range 15cm

MA7338-00



Depth Gauge

- Measuring depth up to 50mm
- Hook part of probe: $\varnothing 1.7\text{mm}$
- Measuring probe (bottom): $\varnothing 1.6\text{mm}$

MA7350-00



Depth Gauge

- Measuring depth up to 70mm

MA7370-00



Direct Reading Depth Gauge

- 23cm length
- Measuring depth up to 40mm

MA7333-10



Arthroscopy Punches

Slimline Basket Punch

- Narrow compact jaw design



Slimline Basket Punch

	Jaws	Width
MA225-800-002	Straight	1.7mm
MA225-800-005	Up biter	1.7mm
MA225-800-011	Up curved shaft	1.7mm



Straight Tip & Shaft



Upwards Angled Tip



Upwards Angled Shaft

Regular Basket Punch



Basket Punch

	Jaws	Width
MA225-800-050	Straight	3.4mm
MA225-800-055	Up biter	1.5mm



Straight Tip & Shaft



Upwards Angled Tip

Arthroscopy Punches

Duckbill Basket Punch

- Multi purpose low profile punch with square bite

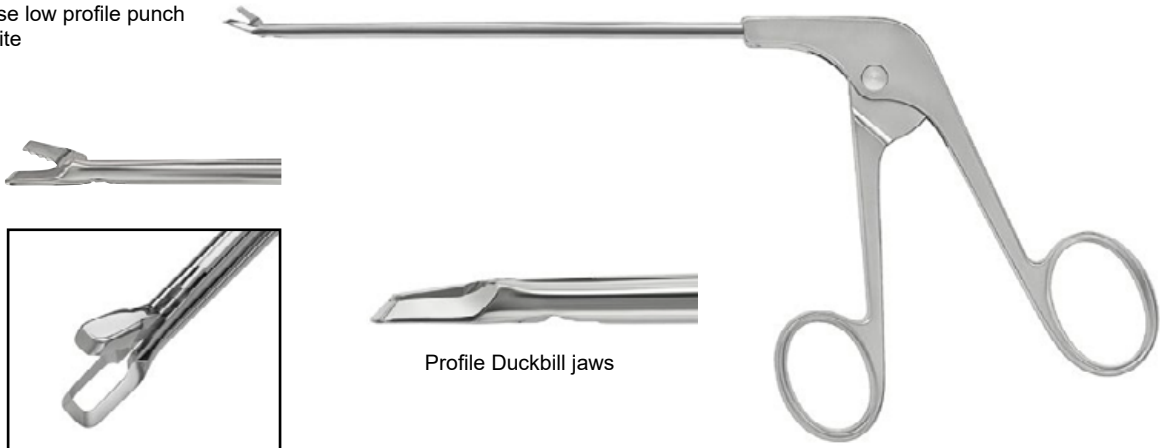

Duckbill Basket Punch



Profile Duckbill jaws

	Jaws	Width
MA225-800-102	Straight	3.2mm
MA225-800-105	Up biter	3.2mm
MA225-800-107	Up biter left	3.2mm
MA225-800-109	Up biter right	3.2mm



Straight Tip & Shaft



Upwards Angled Tip



Curved in Shaft

Duckling Basket Punch

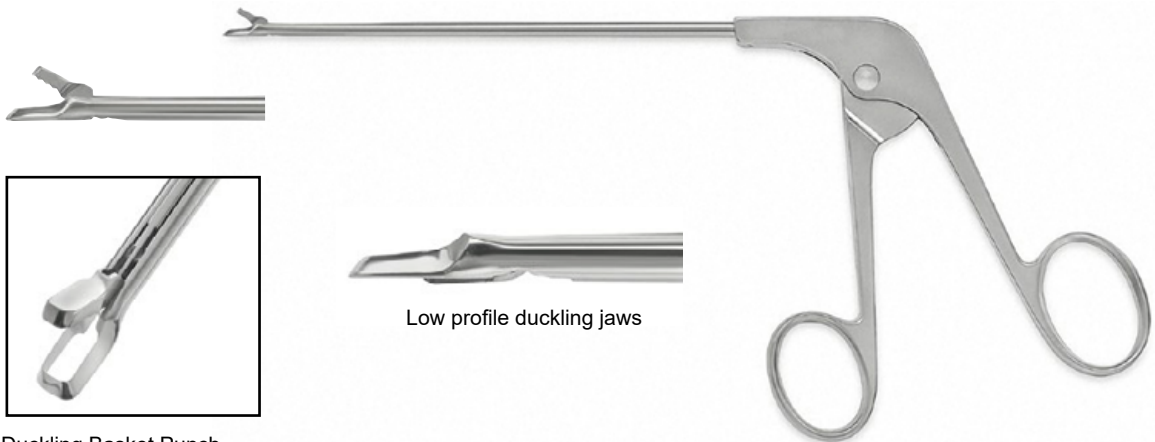

Duckling Basket Punch



Low profile duckling jaws

	Jaws	Width
MA225-800-402	Straight	3.2mm
MA225-800-405	Up biter	3.2mm
MA225-800-411	Up curved shaft	3.2mm
MA225-800-413	Left curved shaft	3.2mm
MA225-800-415	Right curved shaft	3.2mm



Straight Tip & Shaft



Upwards Angled Tip



Upwards Angled Shaft



Curved in Shaft

Arthroscopy Punches

Scissor Punch
 • Extremely slim jaws



Scissor Punch

Jaws Width

MA225-800-532	Straight	1mm
MA225-800-535	Up biter in jaw	1mm



Straight Tip & Shaft

Upwards Angled Tip

Biopsy Rongeur

• Cupped jaw design



Biopsy Rongeur Forceps

MA225-800-920

Arthroscopy Punches

Hook Scissors



Hook Scissors straight

MA225-800-472

Oval Punch

- Low profile large oval bite



Oval Punch straight

	Jaws	Width
MA225-800-202	Straight	4.4mm
MA225-800-205	Up biter	4.4mm
MA225-800-211	Up curved shaft	4.4mm
MA225-800-213	Left curved shaft	4.4mm
MA225-800-215	Right curved shaft	4.4mm



Straight Tip & Shaft



Upwards Angled Tip



Upwards Angled Shaft



Curved in Shaft

Arthroscopy Punches

Back Biter Punches



Scoop Basket Punch

- Short blunt nose



Jaws	Width
MA225-800-802	Straight
MA225-800-813	Shaft curved left
MA225-800-815	Shaft curved right

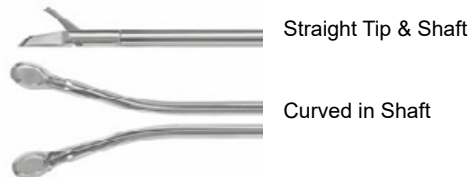

Arthroscopy Grasping Forceps

Grasping Forceps

- With slide lock



Shark Grasping Forceps

MA225-800-820

1x2 interlocking teeth



Alligator Grasping Forceps

MA225-800-825

Multiple bacMAard teeth



Cupped Grasper

MA225-800-833

Cupped serrated jaw 3.3mm



Heavy Alligator Grasping Forceps

MA225-800-835

Larger jaw with multiple teeth

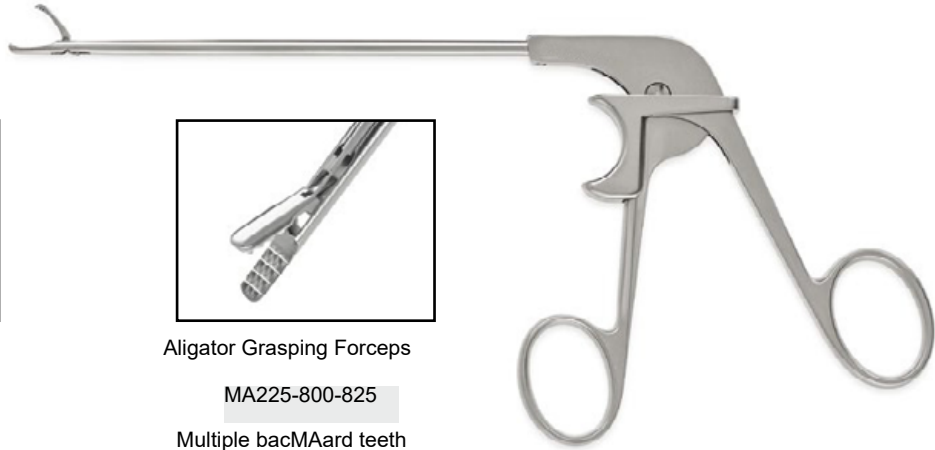

Plastic Sterilising Container

- For 8 Arthroscopy instruments

MA600-513-000



Arthroscopy

Micro Fracture Chondro-Picks

Mercian offers a complete set of Micro Fracture Chondro-Picks for treatment of cartilage defects on large and medium joints.

- All instruments feature an ergonomic carbon fibre handle with impact protection for use with the specially designed mallet.
- 5 different tip angles give the surgeon full flexibility in Micro Fracture surgery.
- Hardened stainless steel ensures a long life-time of each Pick.

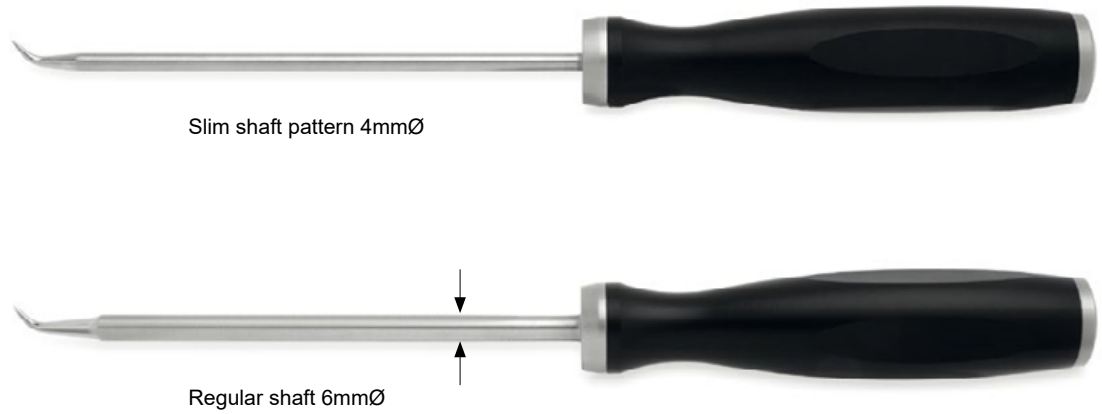

	Slim Shaft 4mmØ	Shaft 6mmØ
	Chondro-Pick Straight MA225-600-200S	Chondro-Pick Straight MA225-600-200
	Chondro-Pick 25° MA225-600-225S	Chondro-Pick 25° MA225-600-225
	Chondro-Pick 40° MA225-600-240S	Chondro-Pick 40° MA225-600-240
	Chondro-Pick 60° MA225-600-260S	Chondro-Pick 60° MA225-600-260
	Chondro-Pick 90° MA225-600-290S	Chondro-Pick 90° MA225-600-290

Arthroscopic Blunt Hook

- 24cm/10" length
- Graduated tip



2.5mm tip

MA225-400-002



3.5mm tip

MA225-400-004

Hook Probe

- 24cm/10" length
- Graduated tip
- 2.5mm tip



MA225-600-004

Arthroscopy

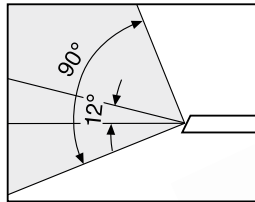

30°



Stryker Compatible Arthroscope 4mm Ø

- 140mm working length
- 30° angle of view

MA225-740-030



High Flow Operating Sheath 6mm Ø

- Stryker locking mechanism
- 2 rotating stopcocks

MA225-570-260



Blunt Obturator 6mm Ø

MA225-570-560



Semi-Sharp Obturator 6mm Ø

MA225-570-760



Dyonics™ Compatible

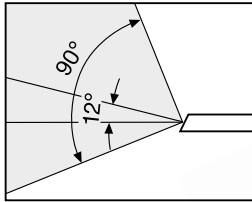

30°

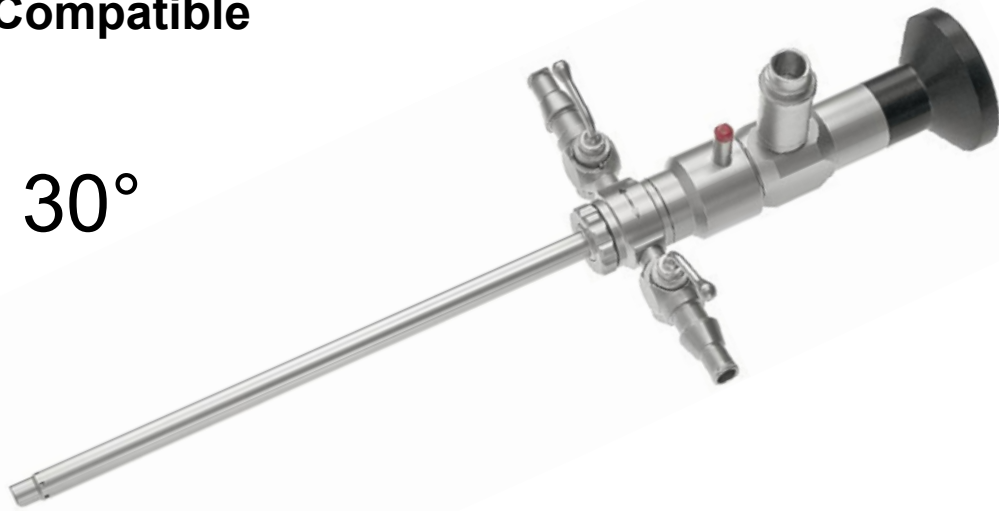

Dyonics Compatible Arthroscope 4mm Ø

- 155mm working length
- 30° angle of view

MA225-440-030



High Flow Operating Sheath 6mm Ø

- Stryker locking mechanism
- 2 rotating stopcocks

MA225-540-260



Blunt Obturator 6mm Ø

MA225-540-560



Sharp Obturator 6mm Ø

MA225-540-760



Regular Fitting

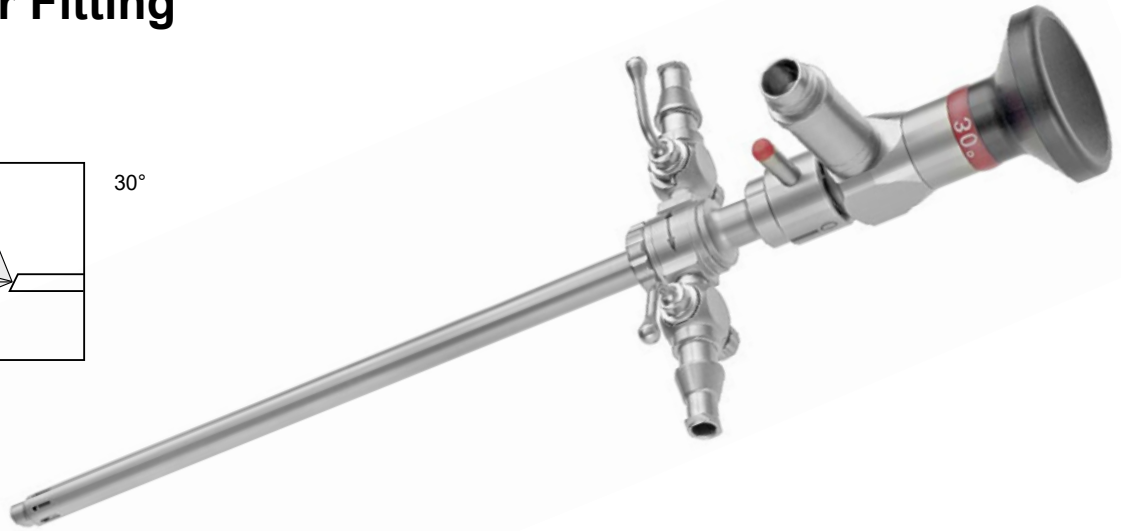
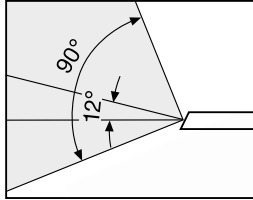

MA225-140-030



High Flow Operating Sheath 6mm Ø

- 2 stopcocks

MA225-500-260



Blunt Obturator 6mm Ø

MA225-500-560



Sharp Obturator 6mm Ø

MA225-500-660



Fiber Optic Light Lead

Fibre Optic Light Lead

Code	Length	Diameter
MA250-035-180	1800mm	3.5mm Ø
MA250-035-230	2300mm	3.5mm Ø
MA250-035-300	3000mm	3.5mm Ø
MA250-048-180	1800mm	4.8mm Ø
MA250-048-230	2300mm	4.8mm Ø
MA250-048-300	3000mm	4.8mm Ø



Adaptors for Light Lead

Lightsource Fittings



Wolf

MA250-037-000



ACMI British Standard

MA250-038-000



Olympus - Standard

MA250-045-000

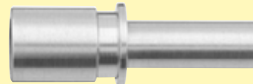

Mercian/Storz

MA250-039-000



Olympus

MA250-044-000



MA250-042-000

Retractor Fitting

Twist Drills

Round Fitting Twist Drill

- Stainless steel
- Supplied sterile in boxes of 10

Code	Diameter	Length	Flute
MA1045-11	1.1mm Ø	45mm	20mm
MA1070-15	1.5mm Ø	70mm	30mm
MA1085-20	2.0mm Ø	85mm	38mm
MA1095-25	2.5mm Ø	95mm	43mm
MA1195-25	2.5mm Ø	195mm	50mm
MA1130-32	3.2mm Ø	130mm	40mm
MA1095-35	3.5mm Ø	95mm	42mm
MA1130-45	4.5mm Ø	130mm	55mm

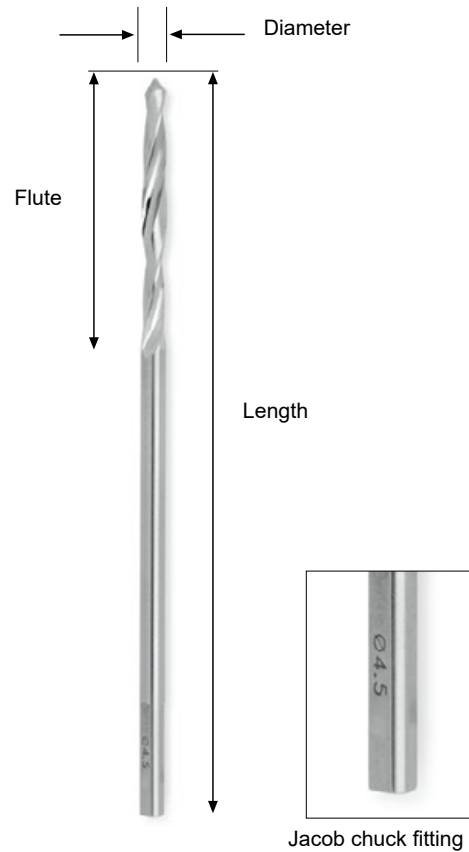

AO Fitting Twist Drill

- Stainless steel
- Supplied sterile in boxes of 10

Code	Diameter	Length	Flute
MA2060-11	1.1mm Ø	60mm	12mm
MA2085-15	1.5mm Ø	85mm	18mm
MA2100-20	2.0mm Ø	100mm	20mm
MA2110-20	2.0mm Ø	110mm	32mm
MA2110-25	2.5mm Ø	110mm	32mm
MA2110-25G	2.5mm Ø	110mm	32mm
MA2100-27	2.7mm Ø	100mm	30mm
MA2150-27	2.7mm Ø	150mm	50mm
MA2145-32	3.2mm Ø	145mm	43mm
MA2195-32	3.2mm Ø	195mm	50mm
MA2110-35	3.5mm Ø	110mm	40mm
MA2195-35	3.5mm Ø	195mm	50mm
MA2145-45	4.5mm Ø	145mm	50mm
MA2195-45	4.5mm Ø	195mm	50mm

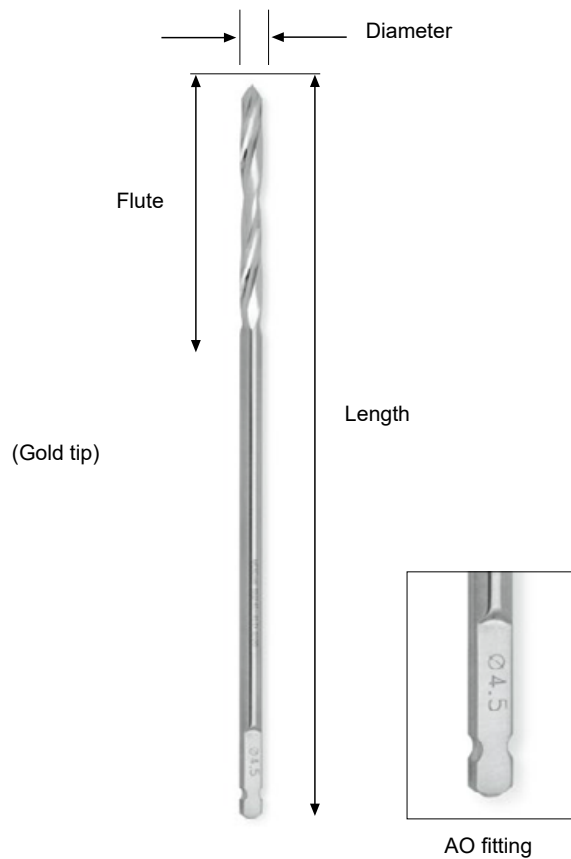

Kirschner Wires

- Stainless steel
- Supplied sterile in boxes of 10

Single Ended	75mm/3"	100mm/4"	125mm/5"	150mm/6"
Ø 0.8mm	MA6075 - 08	MA6100 - 08	MA6125 - 08	MA6150 - 08
Ø 0.9mm	MA6075 - 09	MA6100 - 09	MA6125 - 09	MA6150 - 09
Ø 1.0mm	MA6075 - 10	MA6100 - 10	MA6125 - 10	MA6150 - 10
Ø 1.1mm	MA6075 - 11	MA6100 - 11	MA6125 - 11	MA6150 - 11
Ø 1.2mm	MA6075 - 12	MA6100 - 12	MA6125 - 12	MA6150 - 12
Ø 1.3mm	MA6075 - 13	MA6100 - 13	MA6125 - 13	MA6150 - 13
Ø 1.4mm	MA6075 - 14	MA6100 - 14	MA6125 - 14	MA6150 - 14
Ø 1.5mm	MA6075 - 15	MA6100 - 15	MA6125 - 15	MA6150 - 15
Ø 1.6mm	MA6075 - 16	MA6100 - 16	MA6125 - 16	MA6150 - 16
Ø 1.7mm	MA6075 - 17	MA6100 - 17	MA6125 - 17	MA6150 - 17
Ø 1.8mm	MA6075 - 18	MA6100 - 18	MA6125 - 18	MA6150 - 18
Ø 1.9mm	MA6075 - 19	MA6100 - 19	MA6125 - 19	MA6150 - 19
Ø 2.0mm	MA6075 - 20	MA6100 - 20	MA6125 - 20	MA6150 - 20
Ø 2.2mm	MA6075 - 21	MA6100 - 21	MA6125 - 21	MA6150 - 21
Ø 2.5mm	MA6075 - 22	MA6100 - 22	MA6125 - 22	MA6150 - 22

Double Ended	75mm/3"	100mm/4"	125mm/5"	150mm/6"
Ø 0.8mm	MA7075 - 08	MA7100 - 08	MA7125 - 08	MA7150 - 08
Ø 0.9mm	MA7075 - 09	MA7100 - 09	MA7125 - 09	MA7150 - 09
Ø 1.0mm	MA7075 - 10	MA7100 - 10	MA7125 - 10	MA7150 - 10
Ø 1.1mm	MA7075 - 11	MA7100 - 11	MA7125 - 11	MA7150 - 11
Ø 1.2mm	MA7075 - 12	MA7100 - 12	MA7125 - 12	MA7150 - 12
Ø 1.3mm	MA7075 - 13	MA7100 - 13	MA7125 - 13	MA7150 - 13
Ø 1.4mm	MA7075 - 14	MA7100 - 14	MA7125 - 14	MA7150 - 14
Ø 1.5mm	MA7075 - 15	MA7100 - 15	MA7125 - 15	MA7150 - 15
Ø 1.6mm	MA7075 - 16	MA7100 - 16	MA7125 - 16	MA7150 - 16
Ø 1.7mm	MA7075 - 17	MA7100 - 17	MA7125 - 17	MA7150 - 17
Ø 1.8mm	MA7075 - 18	MA7100 - 18	MA7125 - 18	MA7150 - 18
Ø 1.9mm	MA7075 - 19	MA7100 - 19	MA7125 - 19	MA7150 - 19
Ø 2.0mm	MA7075 - 20	MA7100 - 20	MA7125 - 20	MA7150 - 20
Ø 2.2mm	MA7075 - 21	MA7100 - 21	MA7125 - 21	MA7150 - 21
Ø 2.5mm	MA7075 - 22	MA7100 - 22	MA7125 - 22	MA7150 - 22

Threaded Pins

Steinmann Threaded Pins

- Stainless steel
- Trocar point
- Fully threaded
- Supplied sterile in boxes of 10

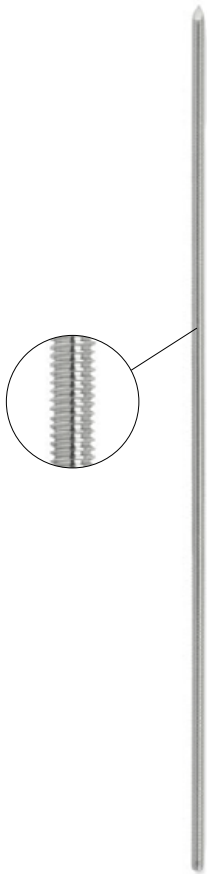

Single Ended	20cm/8"	23cm/9"
Ø 1.4mm	MA8200-14FT	MA8230-14FT
Ø 1.6mm	MA8200-16FT	MA8230-16FT
Ø 1.8mm	MA8200-18FT	MA8230-18FT
Ø 2.0mm	MA8200-20FT	MA8230-20FT
Ø 2.4mm	MA8200-24FT	MA8230-24FT
Ø 2.8mm	MA8200-28FT	MA8230-28FT
Ø 3.2mm	MA8200-32FT	MA8230-32FT

Double Ended	20cm/8"	23cm/9"
Ø 1.4mm	MA9200-14FT	MA9230-14FT
Ø 1.6mm	MA9200-16FT	MA9230-16FT
Ø 1.8mm	MA9200-18FT	MA9230-18FT
Ø 2.0mm	MA9200-20FT	MA9230-20FT
Ø 2.4mm	MA9200-24FT	MA9230-24FT
Ø 2.8mm	MA9200-28FT	MA9230-28FT
Ø 3.2mm	MA9200-32FT	MA9230-32FT

Denham Mid-Threaded Pins

- Stainless steel
- Trocar point/single ended
- Centrally threaded
- Supplied sterile in boxes of 5

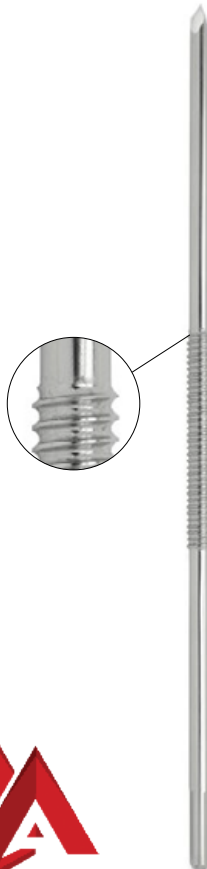

	18cm/7"	20cm/8"	23cm/9"
Ø 4.0mm	MA8180-40CT	MA8200-40CT	MA8230-40CT
Ø 4.5mm	MA8180-45CT	MA8200-45CT	MA8230-45CT
Ø 5.0mm	MA8180-50CT	MA8200-50CT	MA8230-50CT

SMO Steel Wire

SMO Steel Cerclage Wire

- Soft malleable wire
- Supplied in coils of 10m



Wire Ø mm Ø
0.2mm

Length 10m

Ø 0.3mm
Ø 0.4mm
Ø 0.5mm
Ø 0.6mm
Ø 0.7mm
Ø 0.8mm
Ø 0.9mm
Ø 1.0mm
Ø 1.2mm
Ø 1.5mm

MA7600-02
MA7600-03
MA7600-04
MA7600-05
MA7600-06
MA7600-07
MA7600-08
MA7600-09
MA7600-10
MA7600-12
MA7600-15

FORTEEN



M.ASHRAF
INSTRUMENTS

Chirurgische Schmieden

Surgical Forgings

Knochenklammern	Bone Clamps	SF 1
Knochenklammern	Bone Clamps	SF 2
Knochen Skids	Bone Skids	SF 3
Chirurgische Kompressoren	Surgical Compressors	SF 4
Chirurgische Küretten	Surgical Curettes	SF 5
Chirurgische Distraktoren	Surgical Distractors	SF 6
Chirurgische Aufzüge	Surgical Elevators	SF 7
Fixationsklemmen	Fixation Clamps	SF 8
Griffe	Handles	SF 9
Osteotome & Retraktoren Schmiedeteile	Osteotomes & Retractors Forgings	SF 10
Zangen Schmiede	Pliers Forgings	SF 11
Ringgriffklemmen	Ring Handle Clamps	SF 12-13
Kerrison Nagetiere	Rongeurs Kerrison	SF 14
Knochen Nagetiere	Rongeurs Bone	SF 15
Scheren und Rod Benders	Scissors & Rod Bender	SF 16

Knochenklammern
Bone Clamps

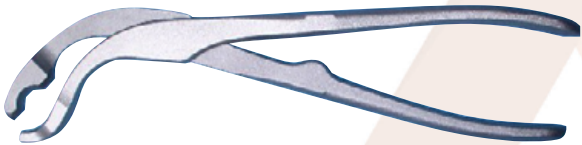
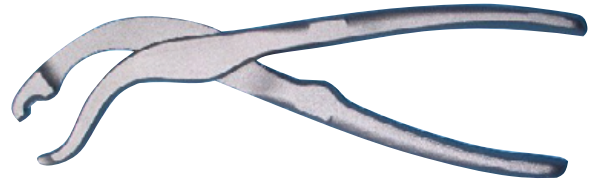

M.ASHRAF
INSTRUMENTS

Knochenklammern
Bone Clamps

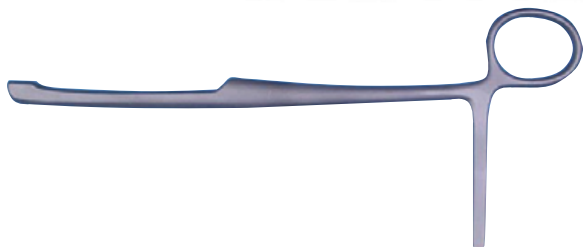

M.ASHRAF
INSTRUMENTS



M.ASHRAF
INSTRUMENTS

Chirurgische Kompressoren
Surgical Compressors



M.ASHRAF
INSTRUMENTS



Chirurgische Küretten
Surgical Curettes

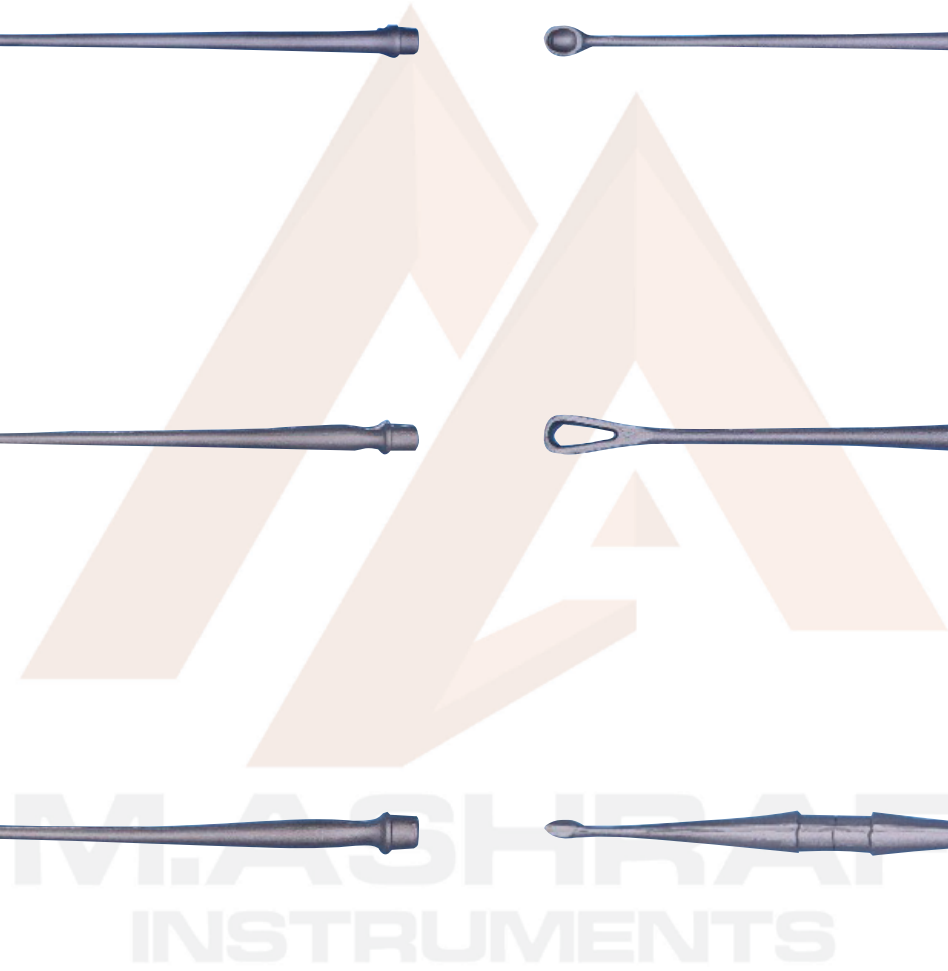

Chirurgische Distraktoren
Surgical Distractors



M.ASHRAF
INSTRUMENTS



M.ASHRAF
INSTRUMENTS

Fixationsklemmen
Fixation Clamps

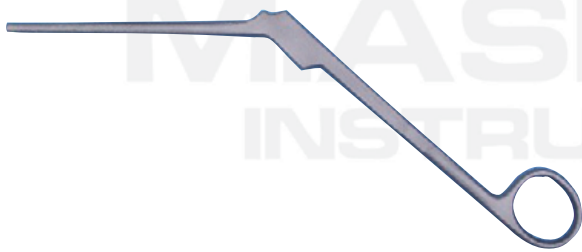
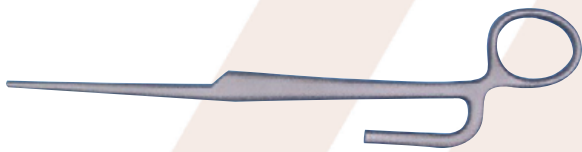
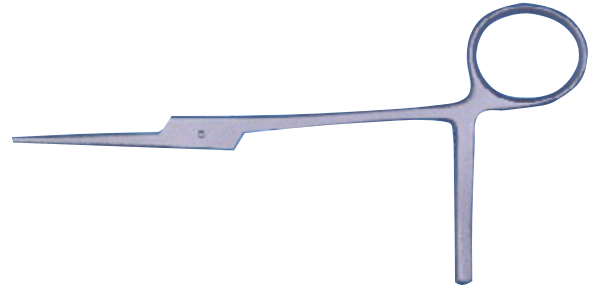
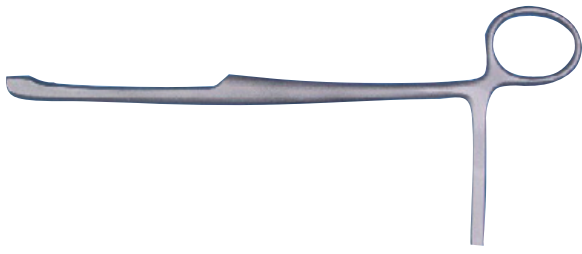

MASHRAF
INSTRUMENTS

Griffe
Handles

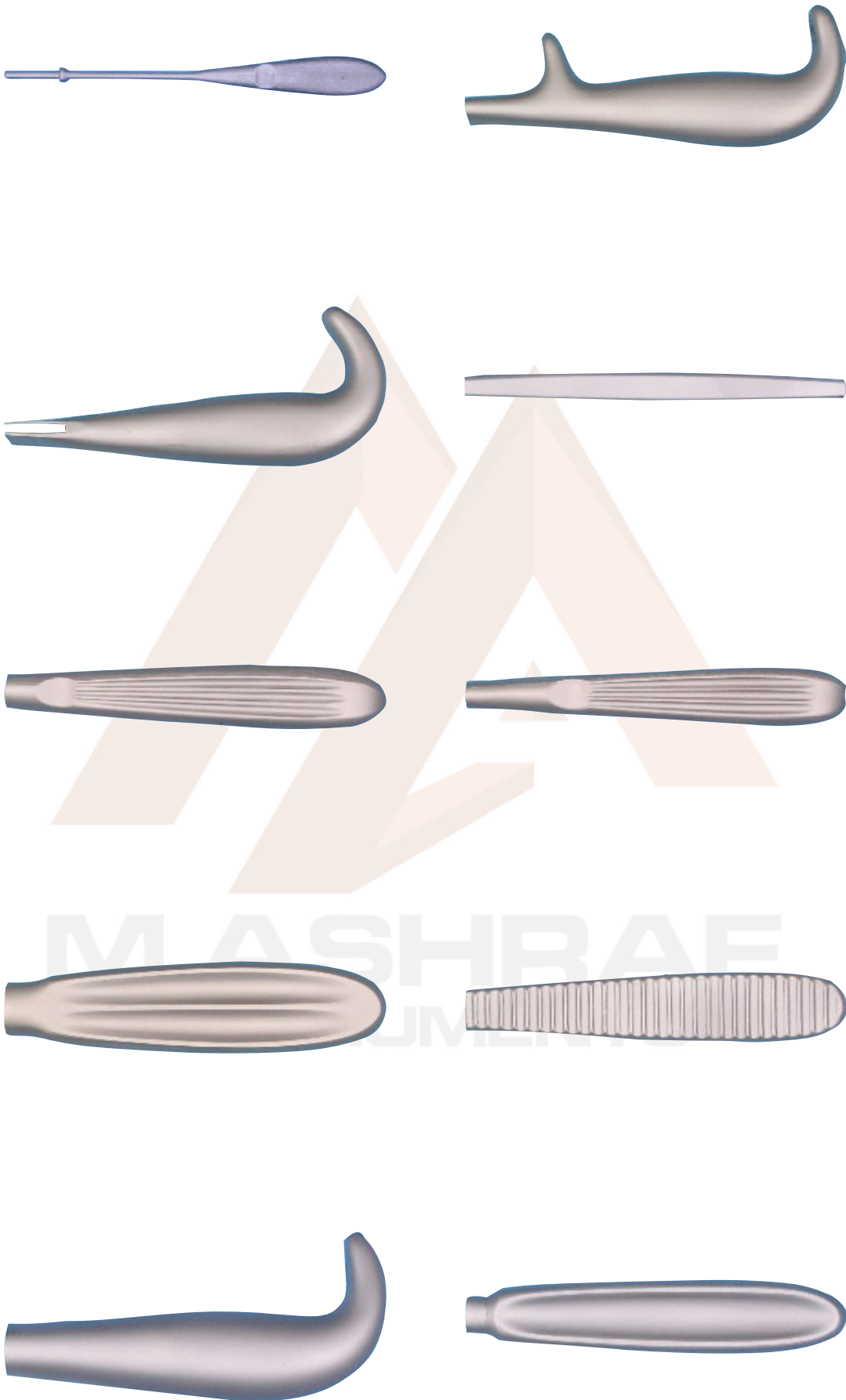

Osteotome & Retraktoren Schmiedeteile
Osteotomes & Retractors Forgings

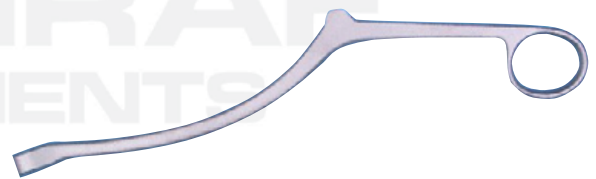
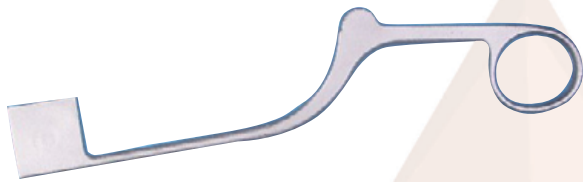

Zangen Schmiede
Pliers Forgings

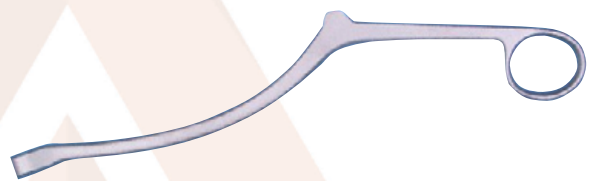

M.ASHRAF
INSTRUMENTS

Ringgriffklemmen
Ring Handle Clamps

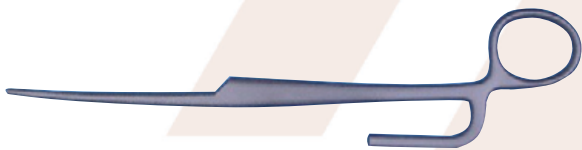

Ringgriffklemmen
Ring Handle Clamps

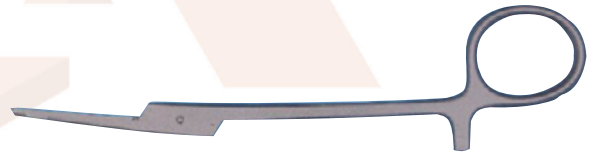
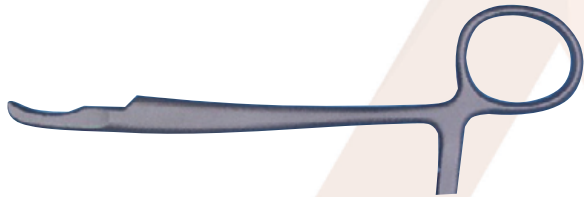

M.ASHRAF
INSTRUMENTS

Kerrison Nagetiere
Rongeurs Kerrison

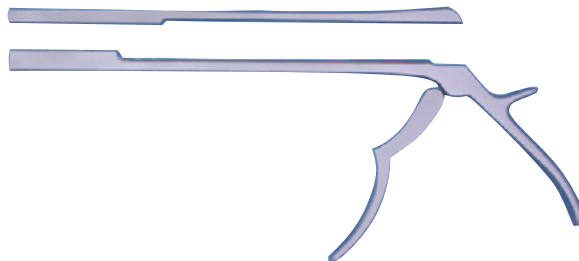
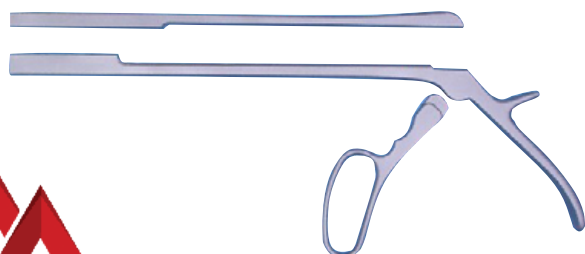
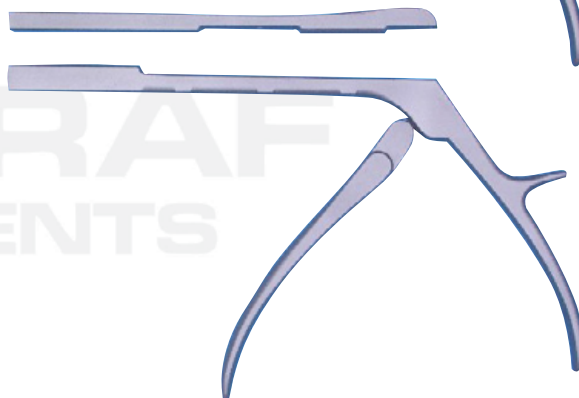
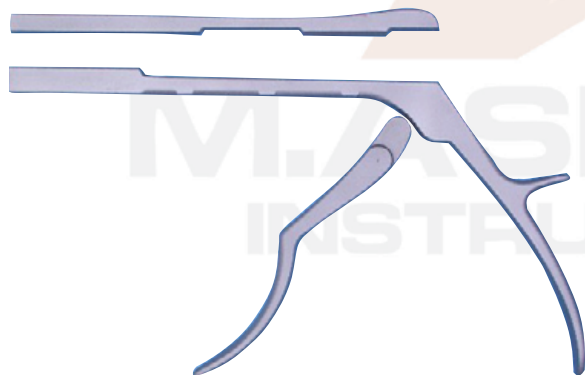
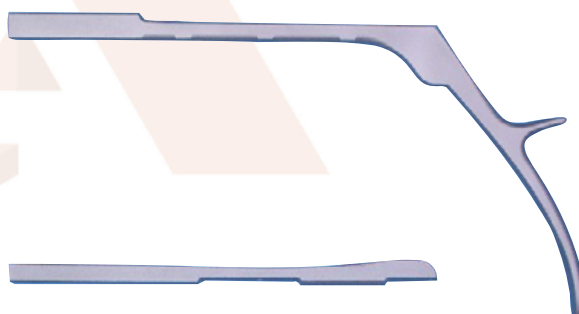

Knochenagetierte
Rongeurs Bone

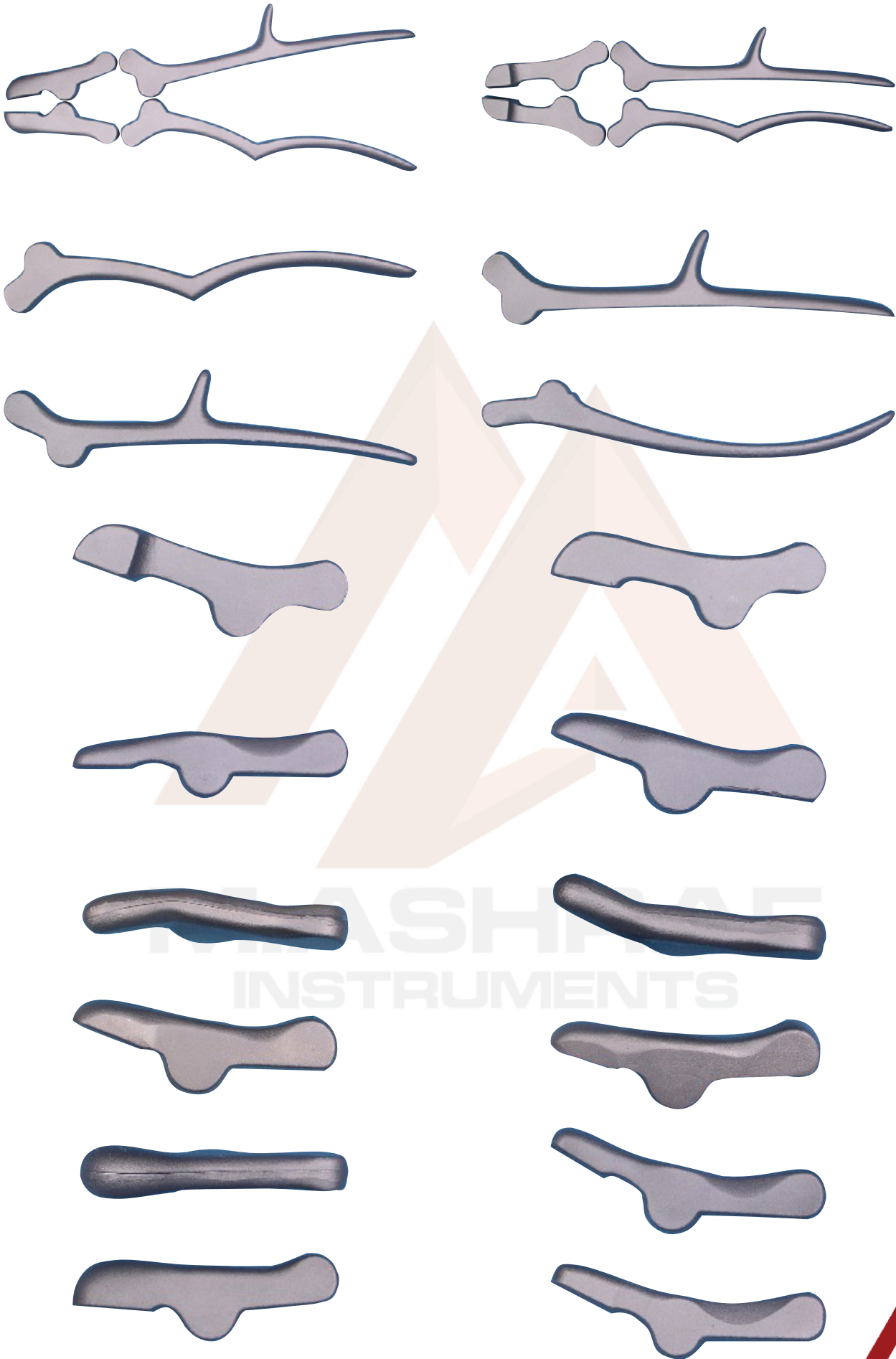

Scheren und Rod Benders
Scissors & Rod Benders



M.ASHRAF
INSTRUMENTS

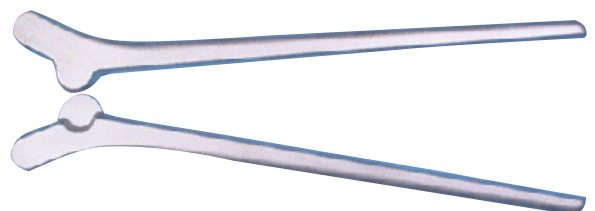



M. ASHRAF INSTRUMENTS

Head Marala Road,
Machi Khokhar,
Sialkot 51310 Pakistan.

Phone: +92-52-4363007
Mobile: +92 300 021 6950
+92 300 043 7950

Emails: info@mashrafsurg.com
Website: www.mashrafsurg.com

